

Techn. Data: Bunkie

Log length (W x D): 290 x 380 cm

Wall size(outside): 270 x 360 cm · Log thickness: 40 mm

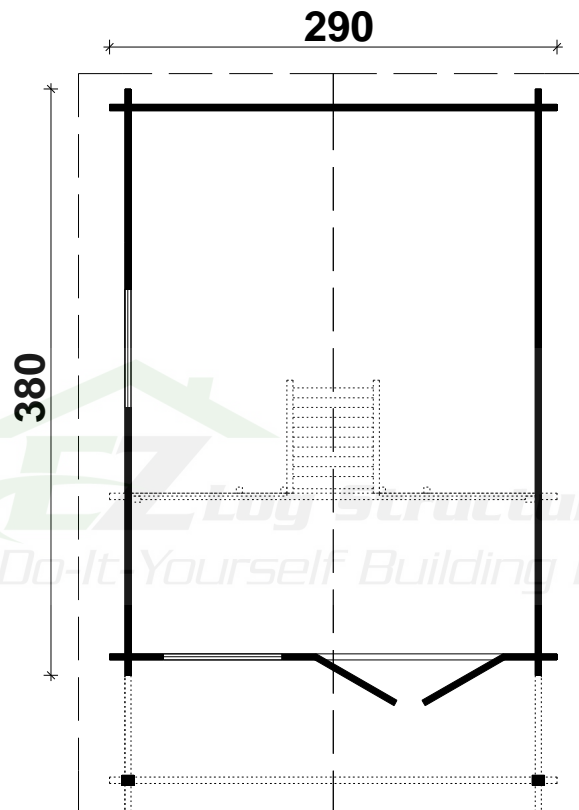









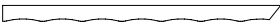







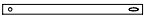

Note: All dimensions are approximate !

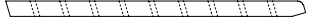
Specification - Bunkie 40 mm / 290 x 380 cm

Nr.	Description	Profile mm	Length mm	Quantity	
001	Foundation beams		2690	2	
002			3450	6	
003			1340	1	
004			350	1	
005			2900	1	
006			2900	2	
007			2900	21	
008			3800	25	
009			1735	9	
010			1340	8	
011			1295	9	
012			350	26	
013			220	9	
014			4700	2	
015			4800	2	
016/01				2900	2
016/02				2834	2
016/03				2551	2
016/04				2267	2
016/05				1984	2
016/06		161		4	
016/07		1270		2	
016/08		1417		2	
016/09		1134		2	
016/10		850		2	
016/11		567		2	
016/12		115		4	
017			4800	2(1+1)	
018			2900	2	
019			4800	1	
020			4800	2	
021	Double door ca. 1200 x 1955mm - 40 mm			1	
022	Window ca. 765 x 990 mm - 40 mm			2	
023	Floor board		2617	32+1	
024			1850	24	
025	Baseboard		ca. 26,0 m		
026	Beam	40 x 90	2620	1	
027	Roof board		2120	88+2	

Specification - Bunkie 40 mm / 290 x 380 cm

Nr.	Description	Profile mm	Length mm	Quantity
028	Facia board 		2170	4
029	Eave edging		2170	4
030	Roof edge reinforcement		4800	2
031	Roof edge reinforcement		4800	2
032	Diamond			2
033	Storm braces 		2150	4
034	Storm braces 		710	4
035	Post 		1965	2
036	Adjustable postfoot 			2
037	Ladder 		2318	2
038	Ladder		520	9
039	Fence		680	6
040	Fence		965	2
041	Fence		740	2
042	Trim		4320	2
043	Trim		200	4
044	Bolt M 8 x 70, nut, washer			20
045	Nails 2,2 x 50 ; 1,4 x 35			1 Bag
046	Ladder fittings 			2(1+1)
047	Screws 4,0 x 40 ; 5,0 x 70 ; 5,0 x 100 ; 6,0 x 140			1 Bag
048	Hit block		300-400	

Bunkie 40 mm / 290 x 380 cm

Foundation beams

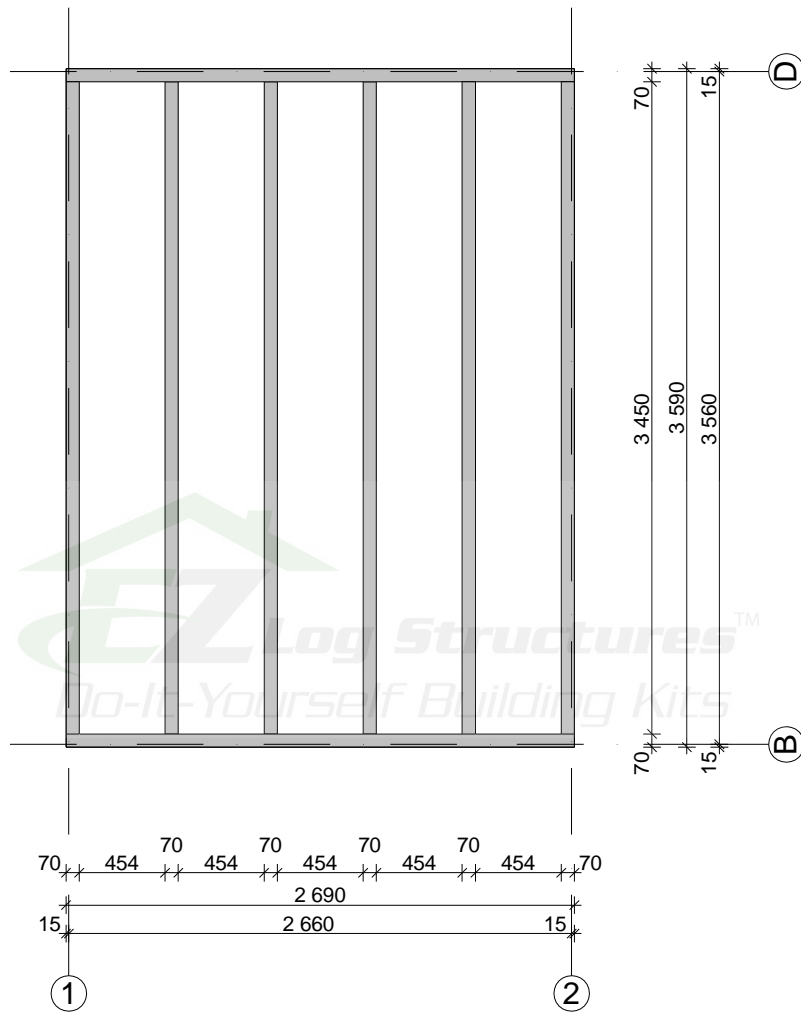

Bunkie 40 mm / 290 x 380 cm

Walls

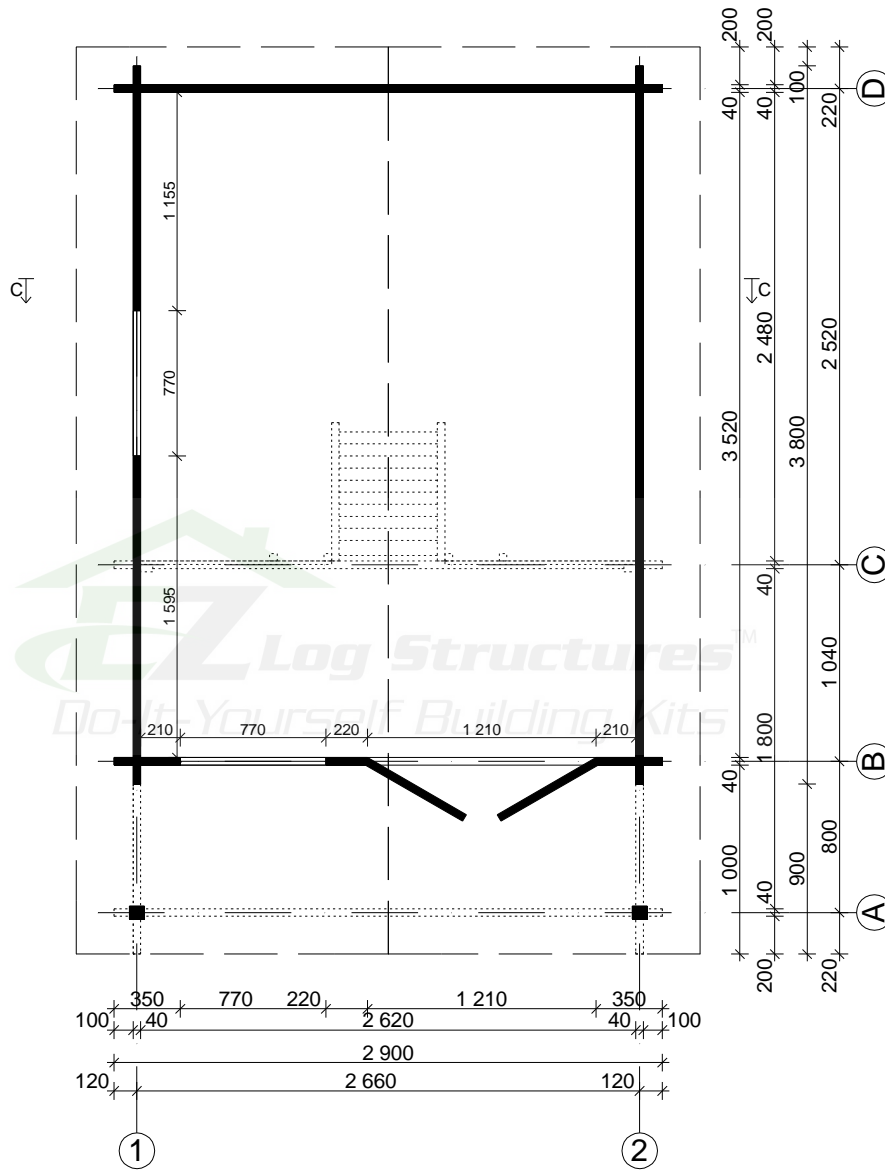

Bunkie 40 mm / 290 x 380 cm

A

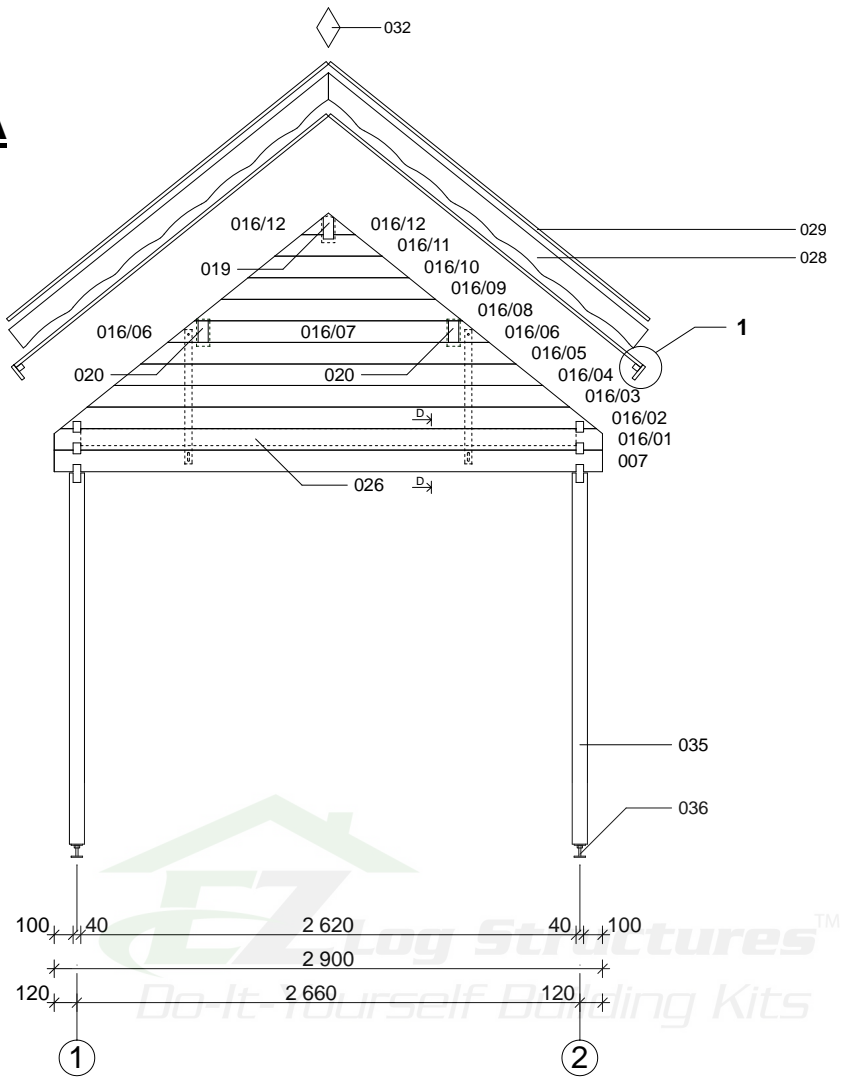

B

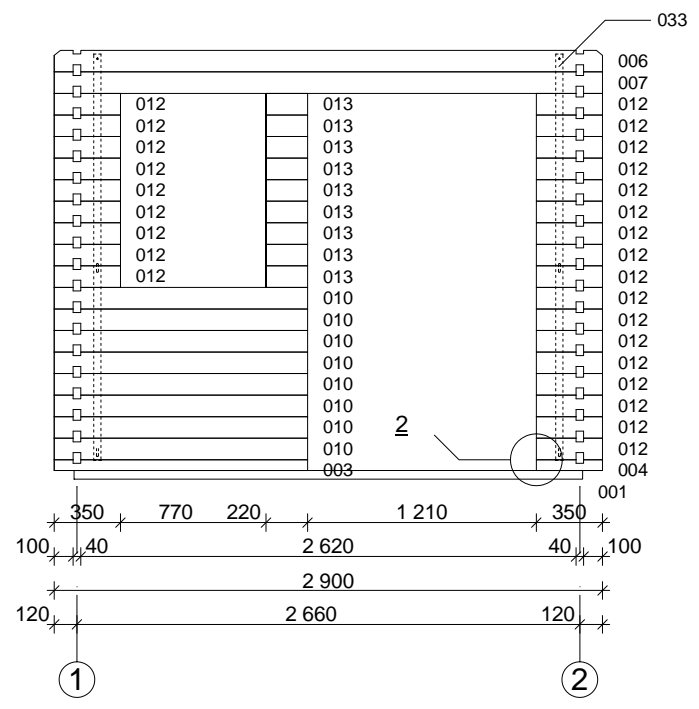

Bunkie 40 mm / 290 x 380 cm

C

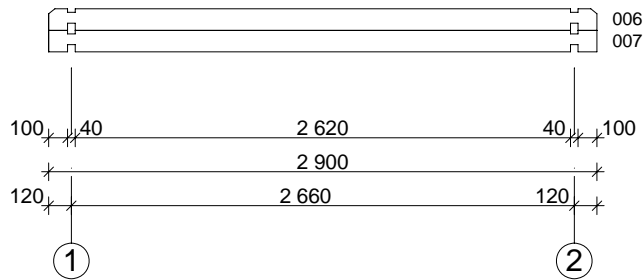

D

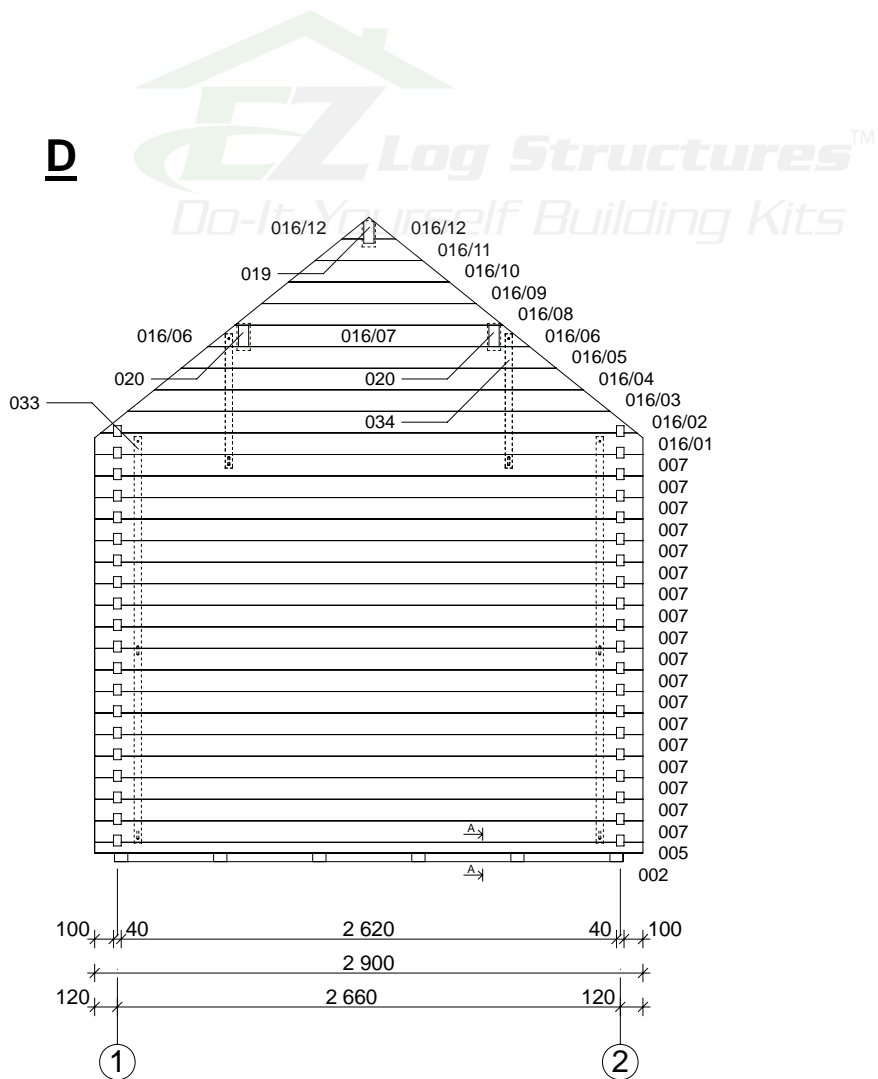

Bunkie 40 mm / 290 x 380 cm

1

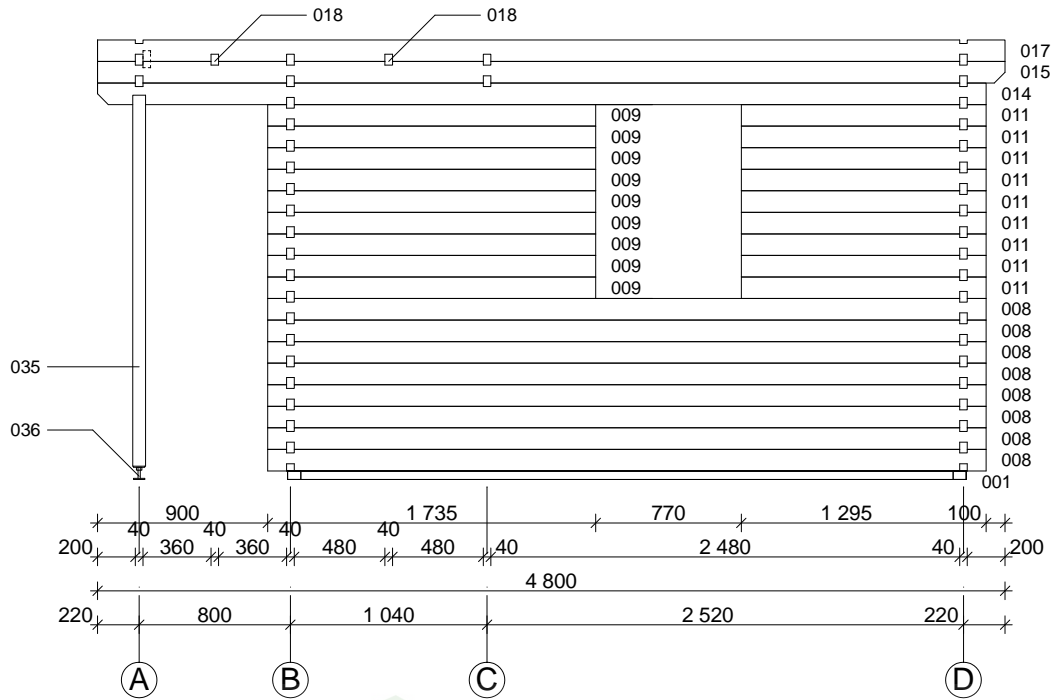

2

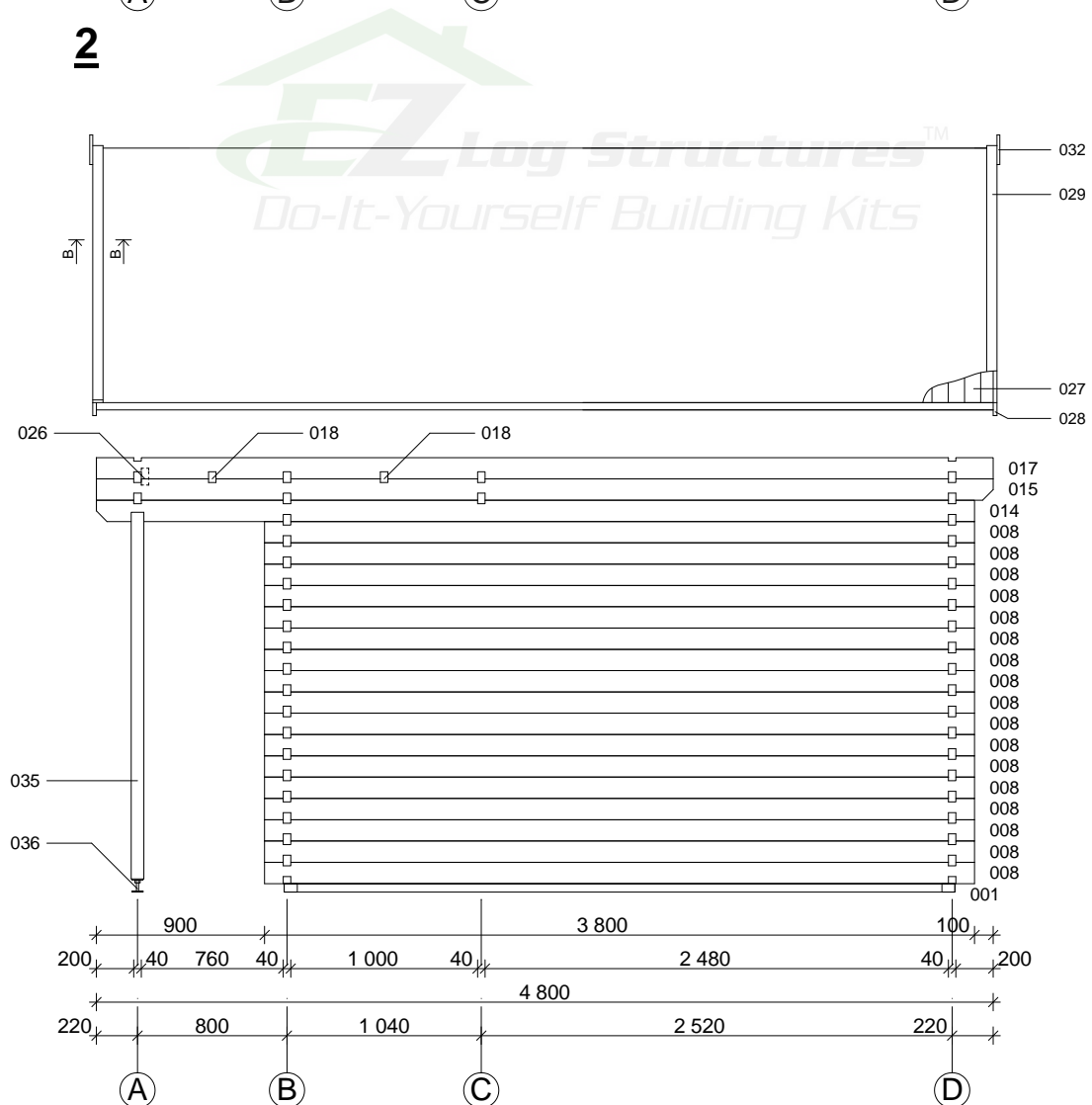

Bunkie 40 mm / 290 x 380 cm

C - C

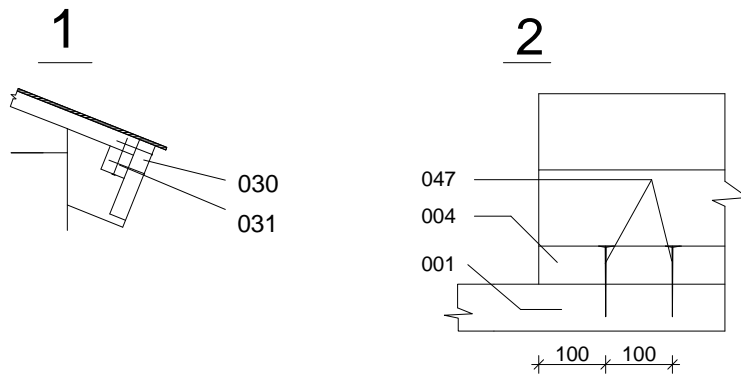
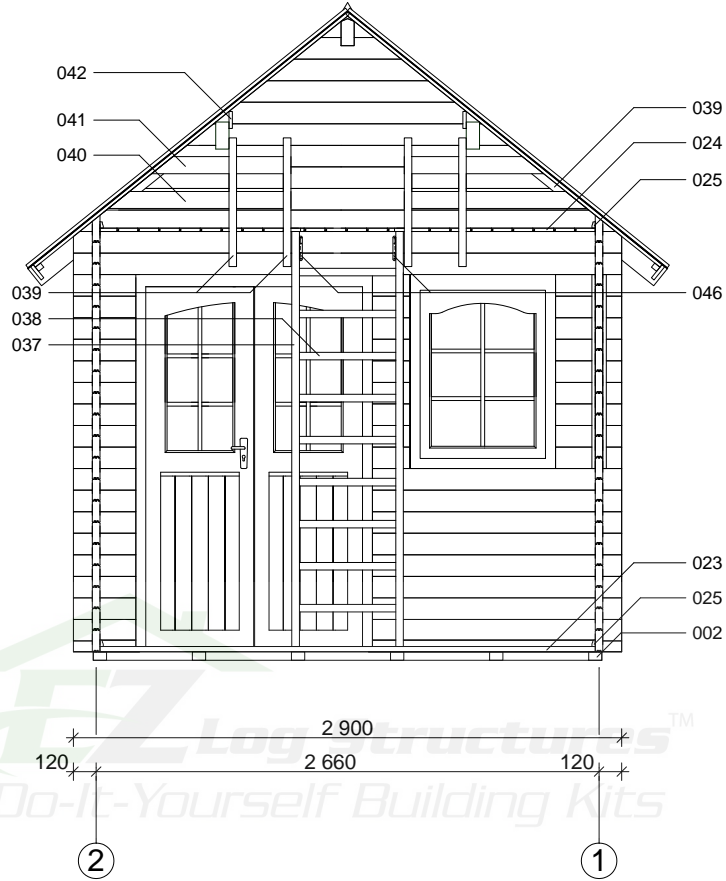

A-A

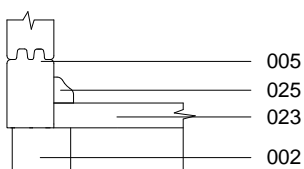

B-B

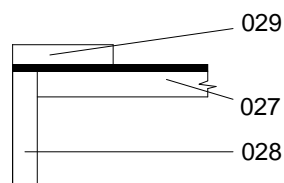

D-D

