

Ohio 28 (180x180)

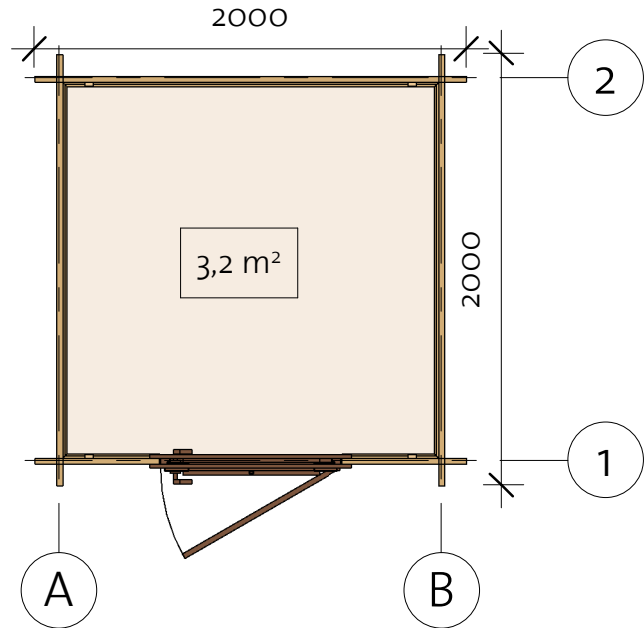
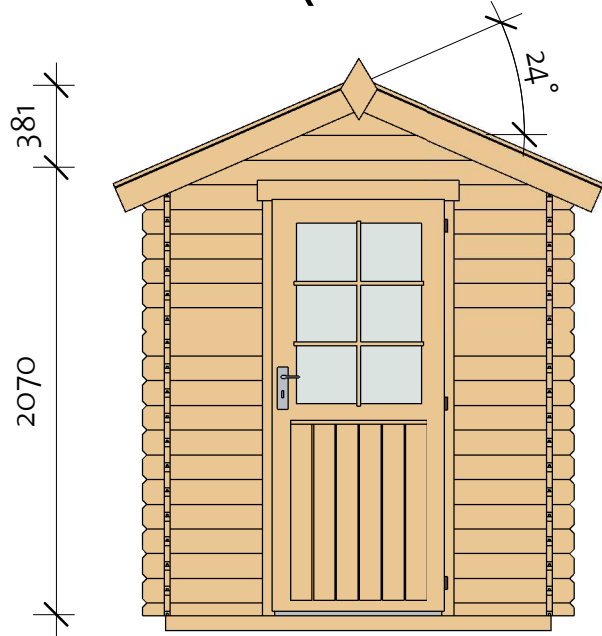

4000001_211118

EZ Log Structures
Do-It-Yourself Building Kits

Ohio 28 (180x180)

Foundation

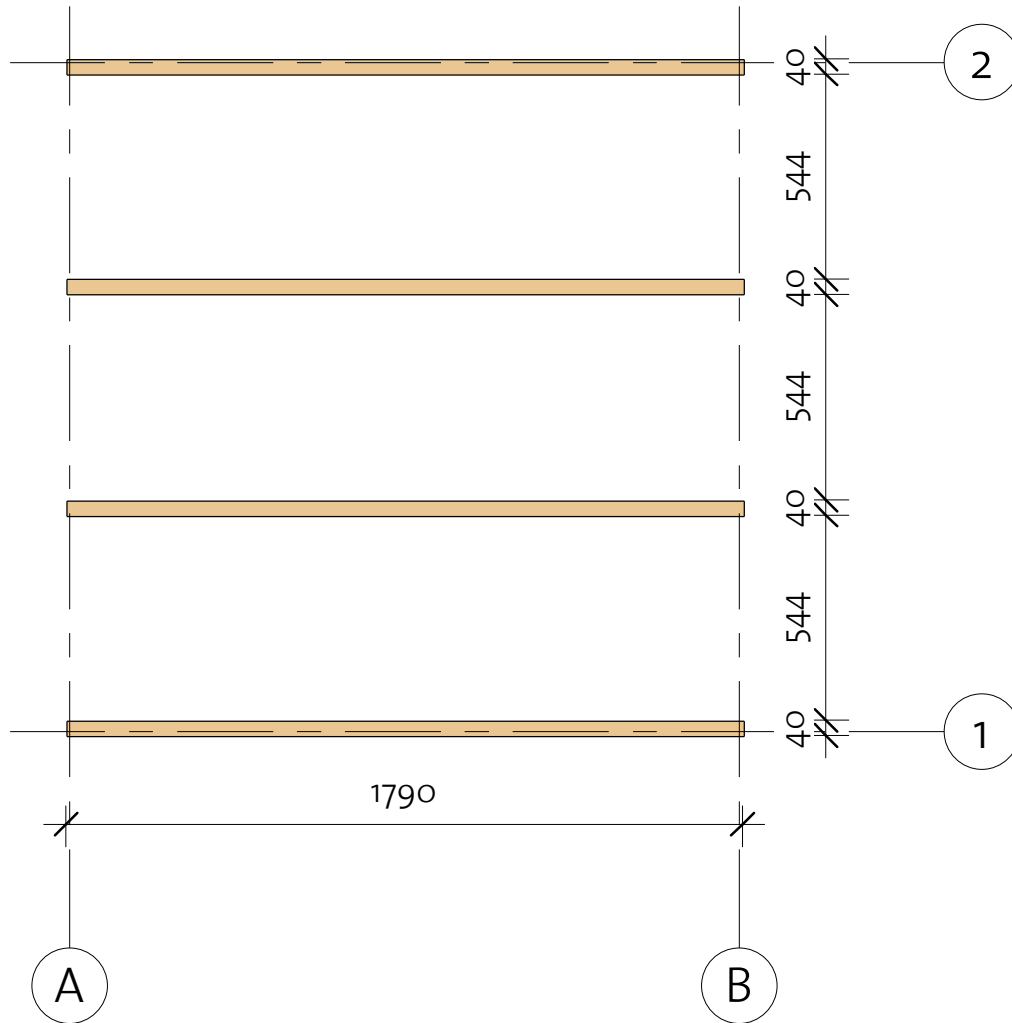

Impregnated foundation beams				
Mark	Type	Profile	Length	Count



IFB	IFB 40x70		1790	4
-----	-----------	---	------	---

Ohio 28 (180x180)

Floor Plan

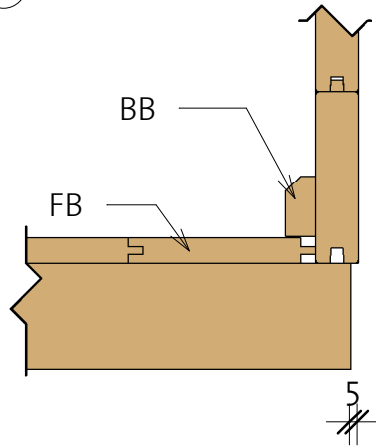
① Baseboard



Floor Schedule				
Mark	Type	Profile	Count	Length
FB	FB 17x114		16	1740
BB	BB 20x40		4	1800

4000001_211118

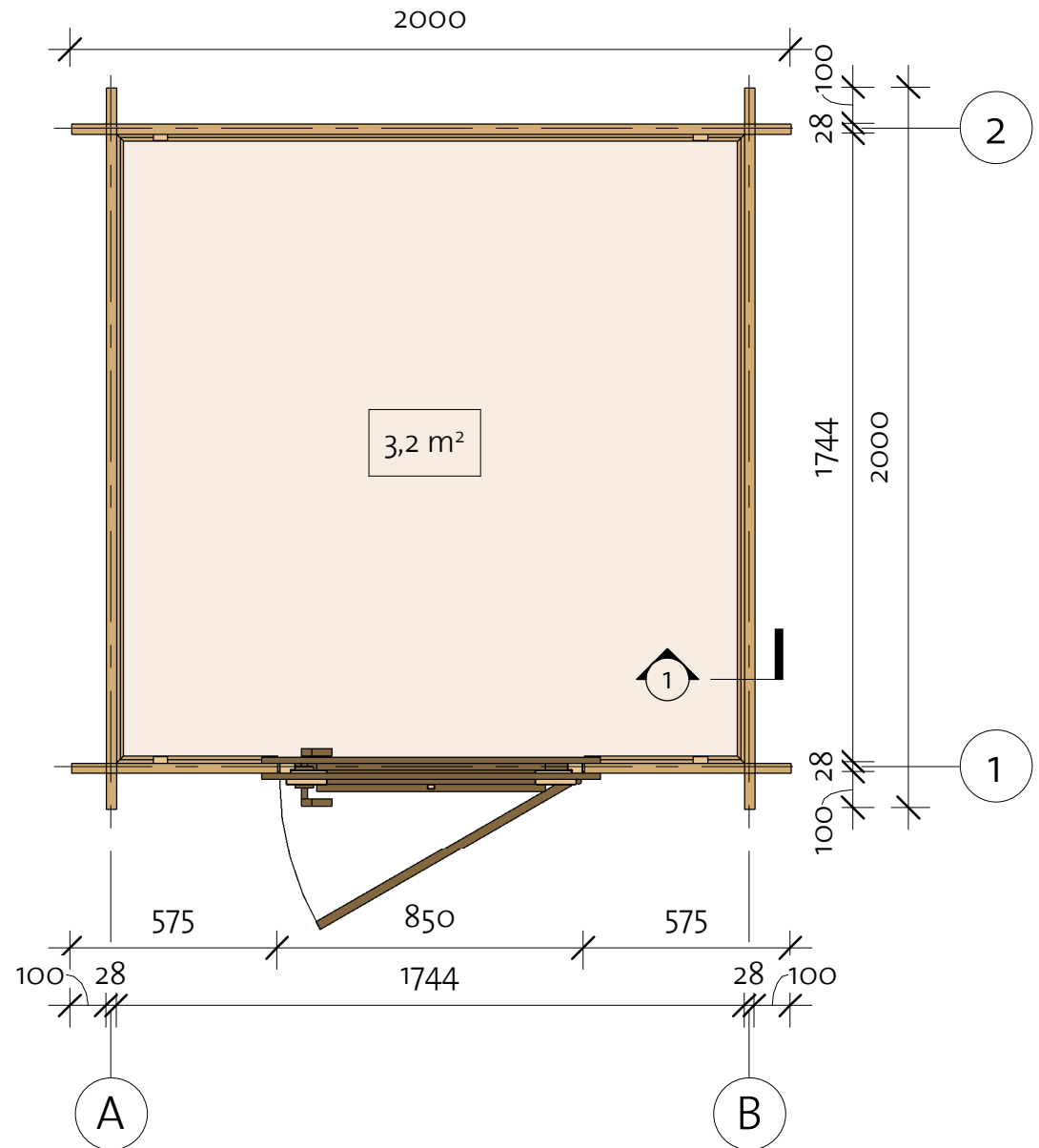

Ohio 28 (180x180)

Wall 1

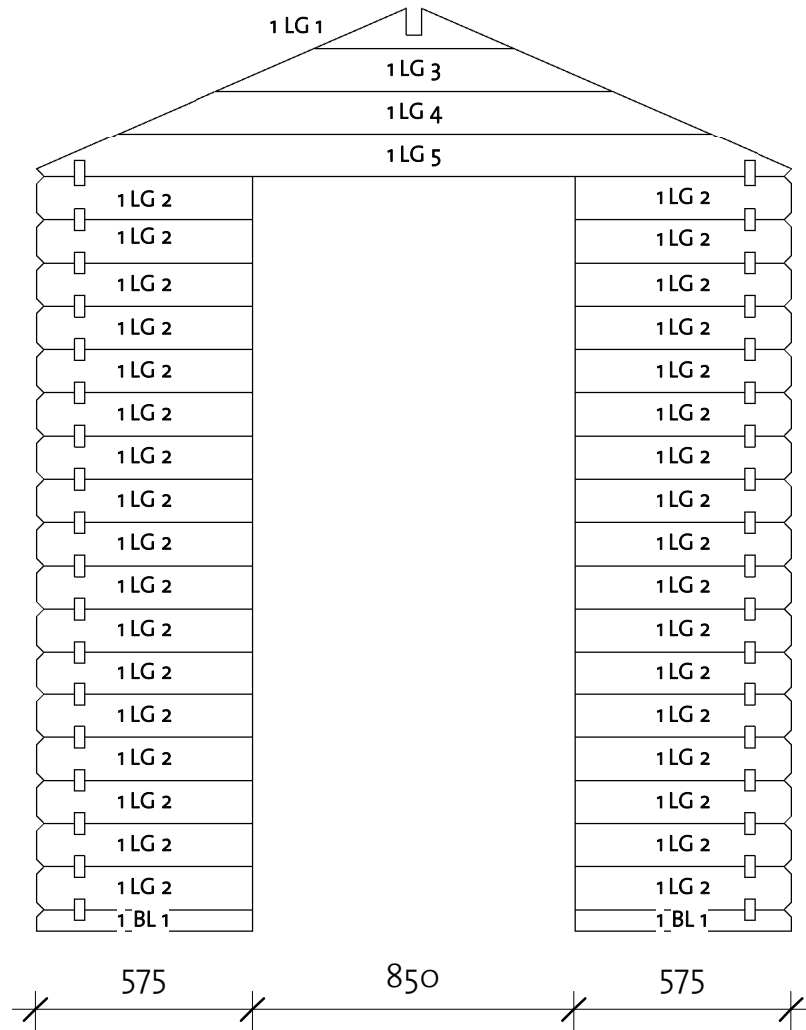
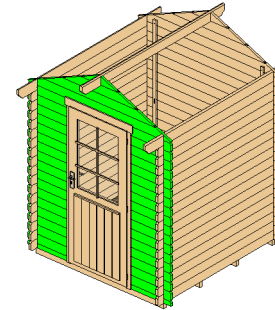

Wall 1			
Mark	Profile	Count	Cut Length

1BL 1	28x57	2	575
1LG 1 *	28x114	1	525
1LG 2	28x114	34	575
1LG 3 *	28x114	1	1047
1LG 4 *	28x114	1	1569
1LG 5 *	28x114	1	2000

* Gable - delivered premounted

Log Profile Wall 1	
Profile	Profile

28x57	
28x114	

Ohio 28 (180x180)

Wall 2

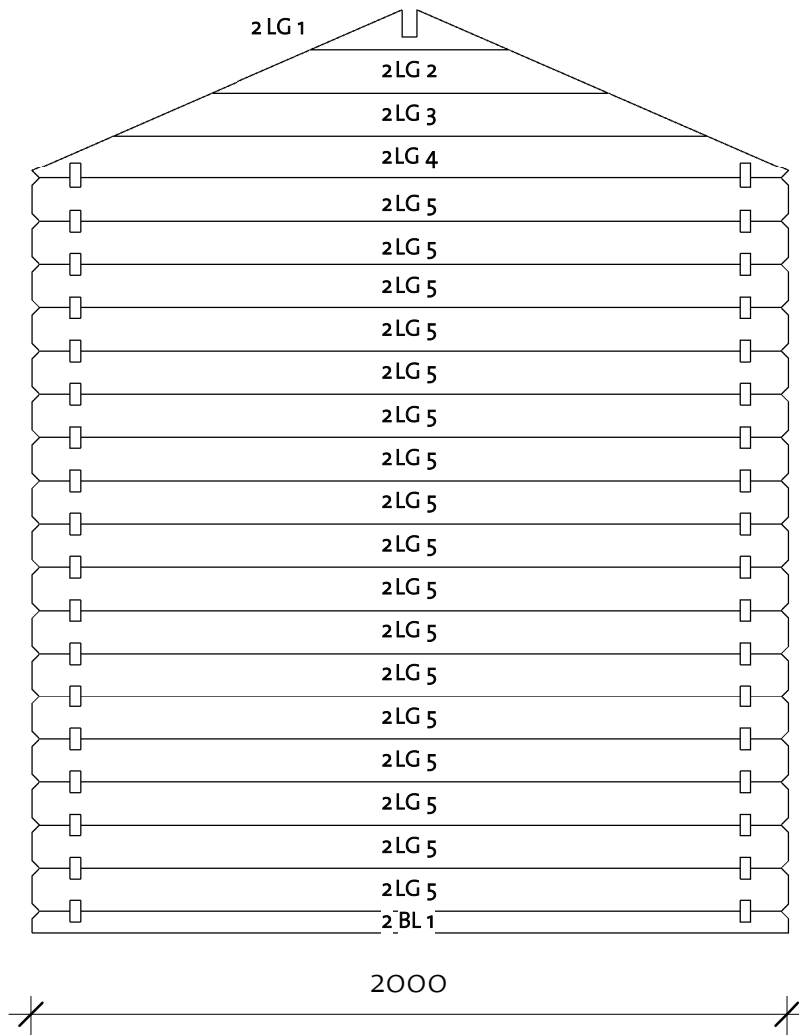
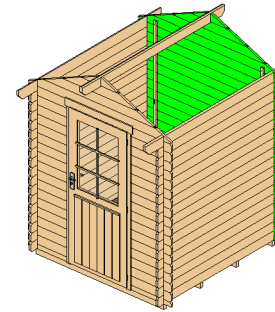

Wall 2			
Mark	Profile	Count	Cut Length

2BL 1	28x57	1	2000
2LG 1*	28x114	1	525
2LG 2*	28x114	1	1047
2LG 3*	28x114	1	1569
2LG 4*	28x114	1	2000
2LG 5	28x114	17	2000

* Gable - delivered premounted

Log Profile Wall 2	
Profile	Profile

28x57	
28x114	

Ohio 28 (180x180)

Wall A

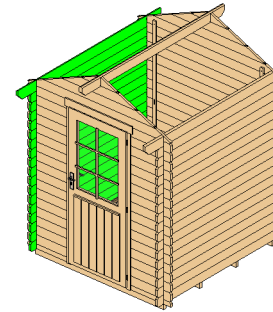

Wall A			
Mark	Profile	Count	Cut Length

ALG 1	28x114	17	2000
ATL 1	28x123	1	2300

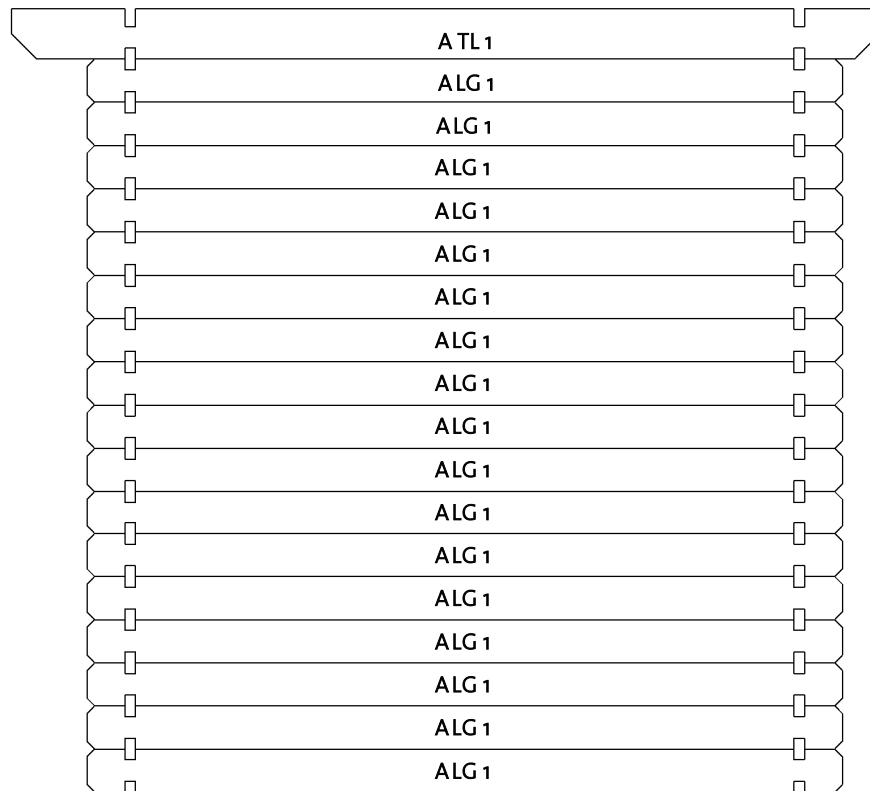

Log Profile Wall A	
Profile	Profile

28x114	
28x123	

Ohio 28 (180x180)

Wall B

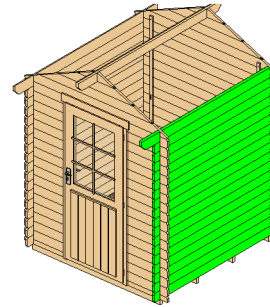

Wall B			
Mark	Profile	Count	Cut Length

BLG 1	28x114	17	2000
BTL 1	28x123	1	2300

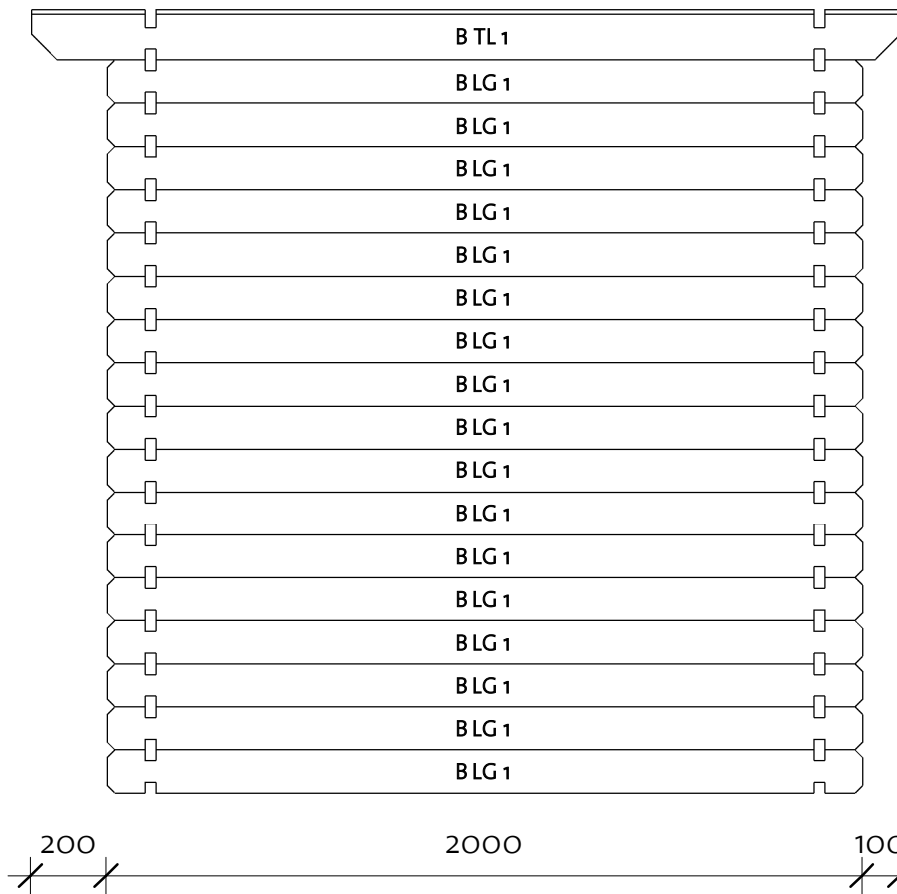



Log Profile Wall B	
Profile	Profile

28x114	
28x123	

Ohio 28 (180x180)

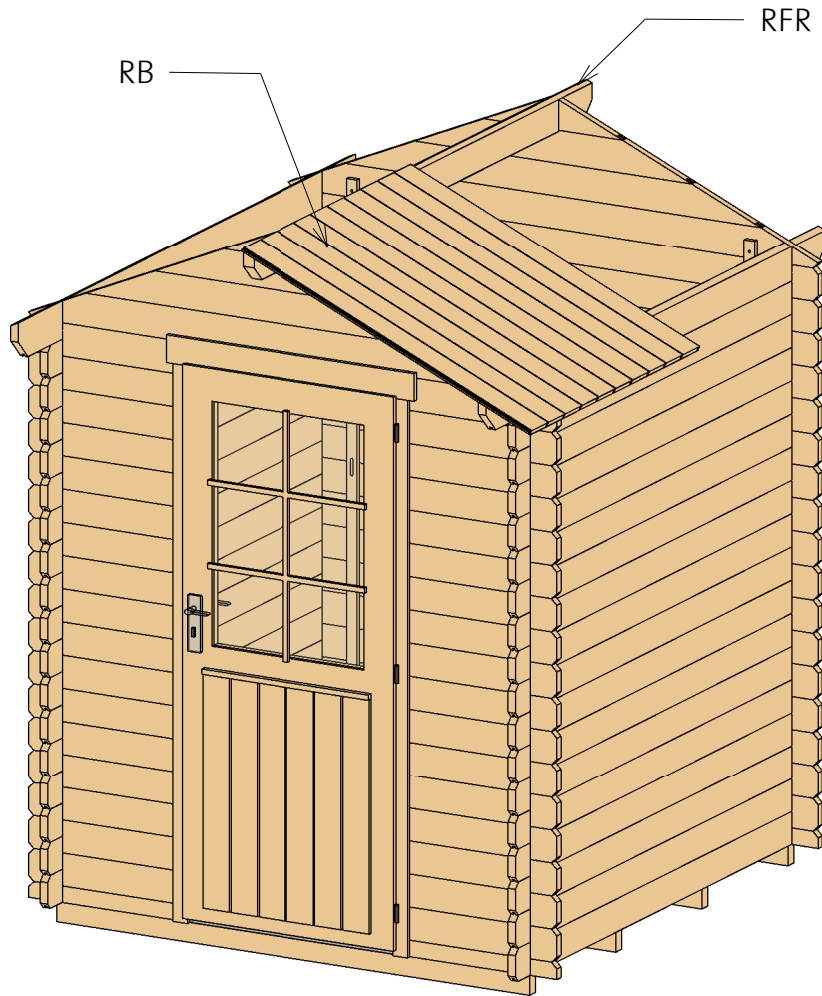
Roof 1



Roof				
Mark	Type	Profile	Count	Length
RFR	Ridge 40x120		1	2300
RB	17x114		42	1190

Ohio 28 (180x180)

Roof 2

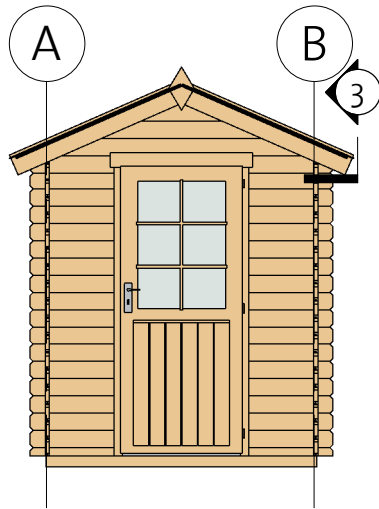
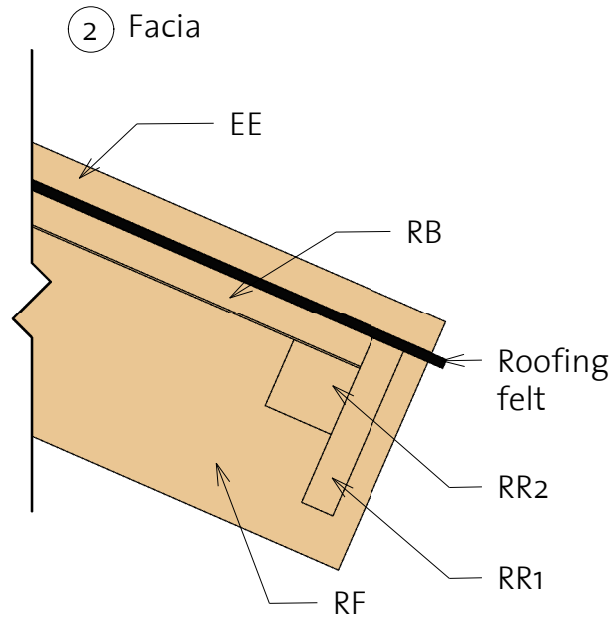
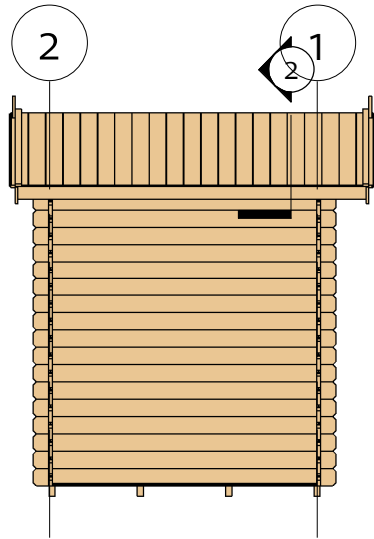

3 Roof Reinforcement

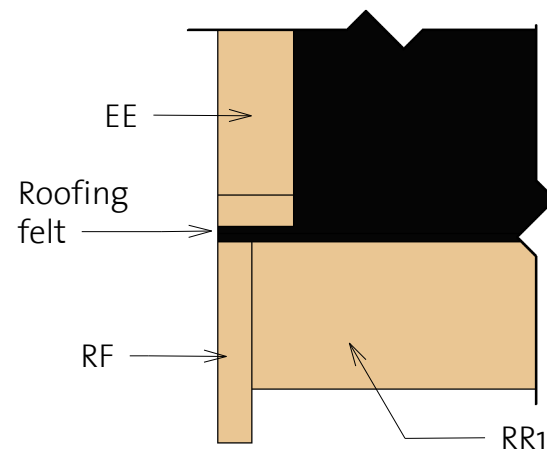

Fascia Schedule

Mark	Type	Profile	Count	Length
EE	Eave Edging 18x40		4	1230
RF	Roof Fascia 18x120		4	1230
RR1	Roof reinforcement 18x95		2	2300
RR2	Roof reinforcement 38x38		2	2300

Ohio 28 (180x180)

Extras



Door Schedule				
Model	Type	Width	Height	Count
BD3R	Basic door 3 right	840	1955	1
DCB4	Door crossbar 4	--	--	1

Fasteners/Extras		
Name	Comments	Count

Hitblock	300-400 mm	
Screws	5,0 x 70	10
Bolts	M8 x 60	12
Nails	1,4 x 40	20
Screws	6,0 x 140	25
Screws	4,0 x 40	250



Type	Count	Length
Windboard 18x40	4	2200

Type	Count
Romb	2



4000001_211118

Ohio 28 (180x180)

List of all items 1

Impregnated foundation beams				
Mark	Type	Profile	Length	Count



IFB	IFB 40x70		1790	4
-----	-----------	---	------	---

Floor Schedule				
Mark	Type	Profile	Count	Length





FB	FB 17x114		16	1740
----	-----------	---	----	------

BB	BB 20x40		4	1800
----	----------	---	---	------

Roof				
Mark	Type	Profile	Count	Length

RFR	Ridge 40x120		1	2300
RB	17x114		42	1190

Fascia Schedule				
Mark	Type	Profile	Count	Length

EE	Eave Edging 18x40		4	1230
RF	Roof Fascia 18x120		4	1230
RR1	Roof reinforcement 18x95		2	2300
RR2	Roof reinforcement 38x38		2	2300

Ohio 28 (180x180)

List of all items 2

Wall 1			
Mark	Profile	Count	Cut Length

1BL 1	28x57	2	575
1LG 1 *	28x114	1	525
1LG 2	28x114	34	575
1LG 3 *	28x114	1	1047
1LG 4 *	28x114	1	1569
1LG 5 *	28x114	1	2000

* Gable - delivered premounted

Wall 2			
Mark	Profile	Count	Cut Length

2BL 1	28x57	1	2000
2LG 1 *	28x114	1	525
2LG 2 *	28x114	1	1047
2LG 3 *	28x114	1	1569
2LG 4 *	28x114	1	2000
2LG 5	28x114	17	2000



Wall A			
Mark	Profile	Count	Cut Length

ALG 1	28x114	17	2000
ATL 1	28x123	1	2300

Wall B			
Mark	Profile	Count	Cut Length

BLG 1	28x114	17	2000
BTL 1	28x123	1	2300

Log Profiles	
Profile	Profile

28x57	
28x114	

Log Profiles	
Profile	Profile

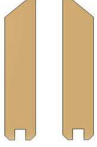
28x123	
--------	---