

# Toronto 28 (149 5/8" x 110 1/4")

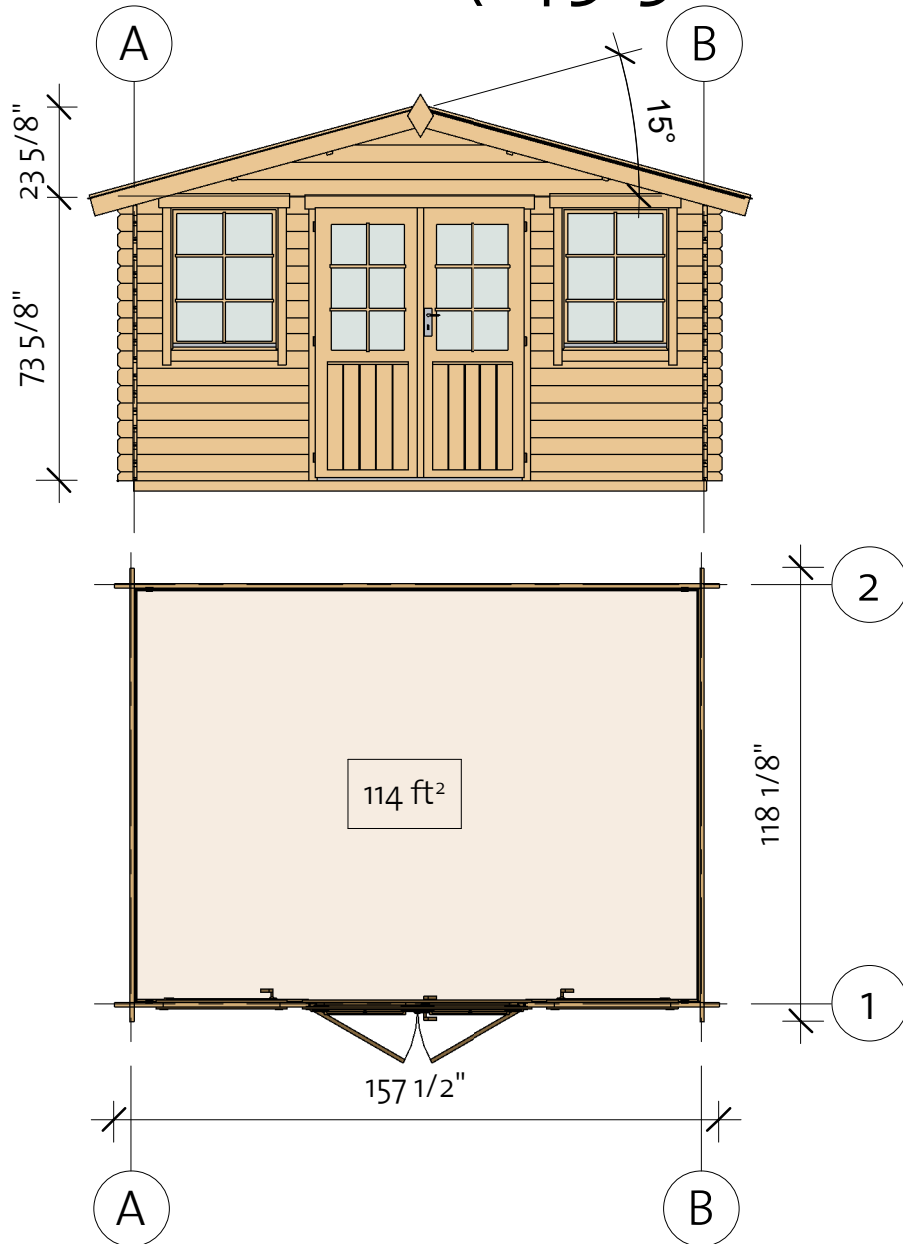

4000011\_210423

**EZ** Log Structures  
Do-It-Yourself Building Kits

# Toronto 28 (149 5/8" x 110 1/4")

Foundation

Impregnated foundation beams				
Mark	Type	Profile	Count	Length



IFB	IFB 40x70		6	149 1/4"
-----	--------------	---	---	-------------

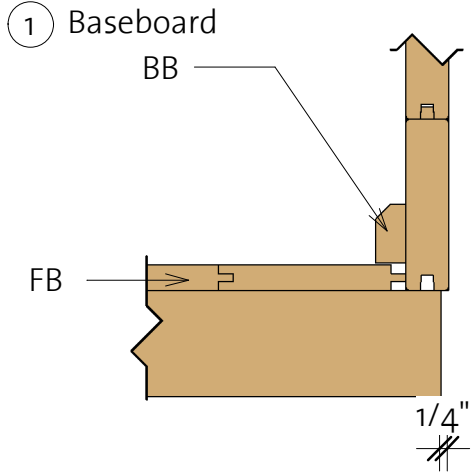

# Toronto 28 (149 5/8" x 110 1/4")

Floor Plan



Floor Schedule				
Mark	Type	Profile	Count	Length
FB	FB 17x114		34	107 7/8"
BB1	BB 20x40		2	149 5/8"
BB2	BB 20x40		2	110 1/4"

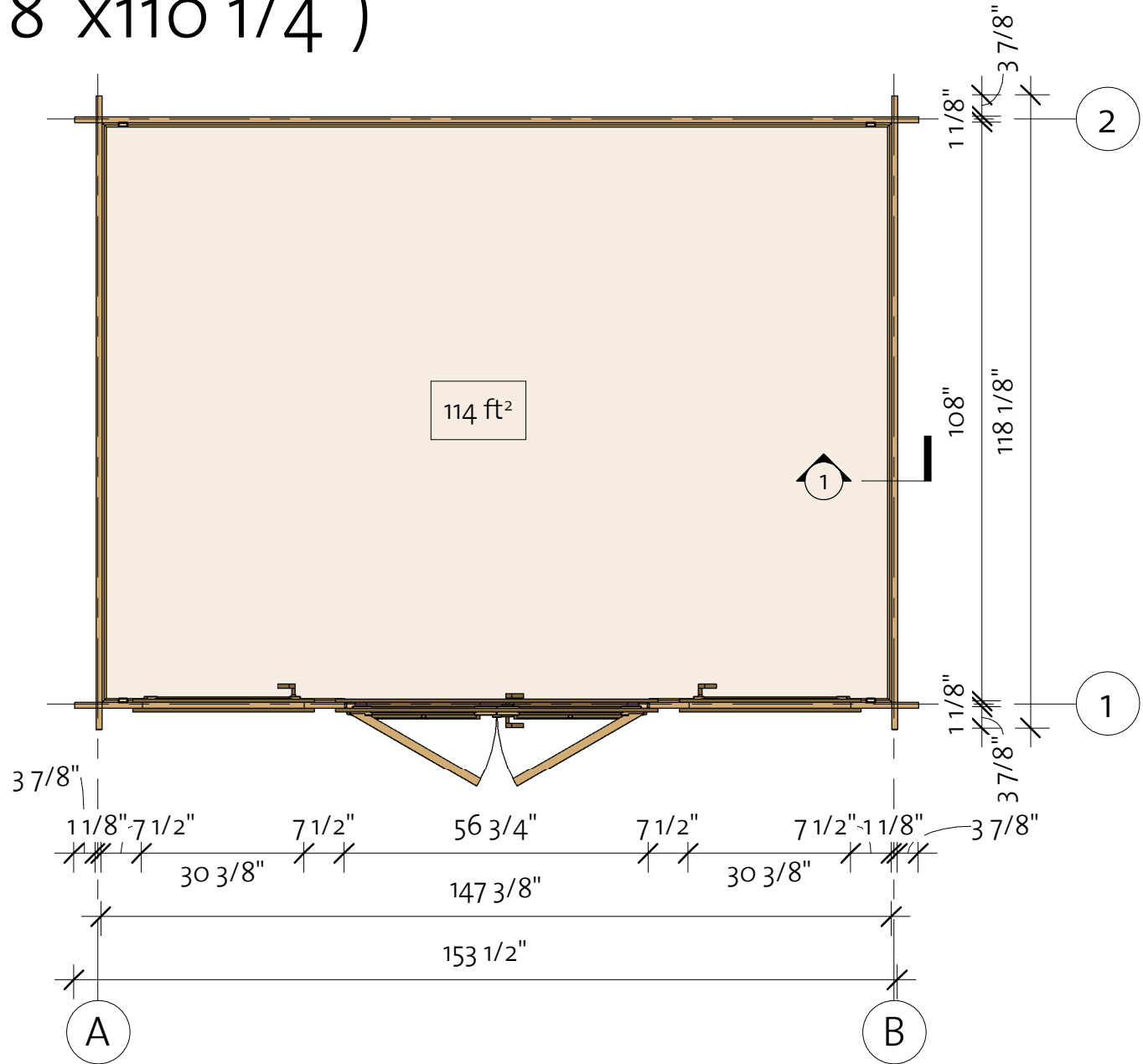

# Toronto 28 (149 5/8" x 110 1/4")

Wall 1

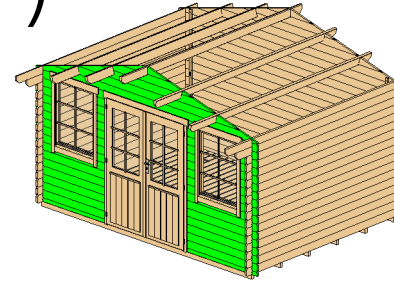

Wall 1			
Mark	Profile	Count	Cut Length

1BL 1	28x57	2	50 3/8"
1LG 1	28x114	18	7 1/2"
1LG 2	28x114	18	12 5/8"
1LG 3 *	28x114	1	32 3/4"
1LG 4 *	28x114	1	65 1/2"
1LG 5	28x114	14	50 3/8"
1LG 6 *	28x114	1	97 1/2"
1LG 7 *	28x114	1	131"
1LG 8 *	28x114	1	157 1/2"

\*Gable-delivered premounted

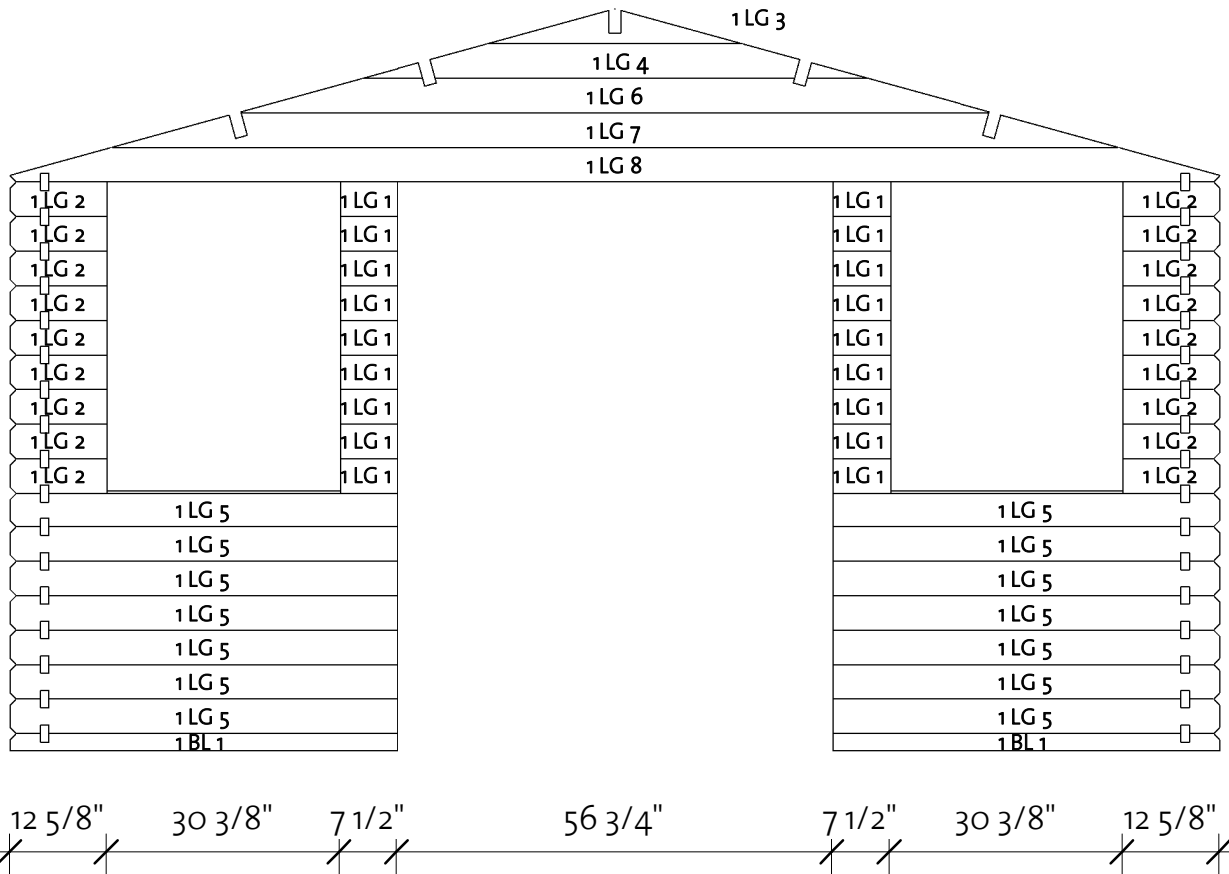

Log Profile Wall 1	
Profile	Profile

28x57	
28x114	

# Toronto 28 (149 5/8" x 110 1/4")

Wall 2

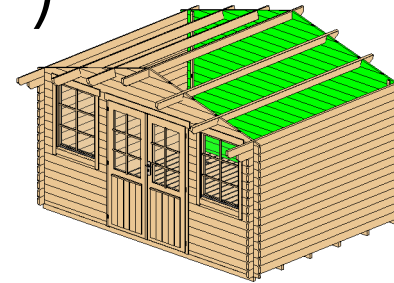

Wall 2			
Mark	Profile	Count	Cut Length

2BL 1	28x57	1	157 1/2"
2LG 1 *	28x114	1	32 3/4"
2LG 2 *	28x114	1	65 1/2"
2LG 3 *	28x114	1	97 1/2"
2LG 4 *	28x114	1	131"
2LG 5 *	28x114	1	157 1/2"
2LG 6	28x114	16	157 1/2"

\*Gable-delivered premounted

Log Profile Wall 2	
Profile	Profile

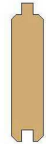
28x57	
28x114	

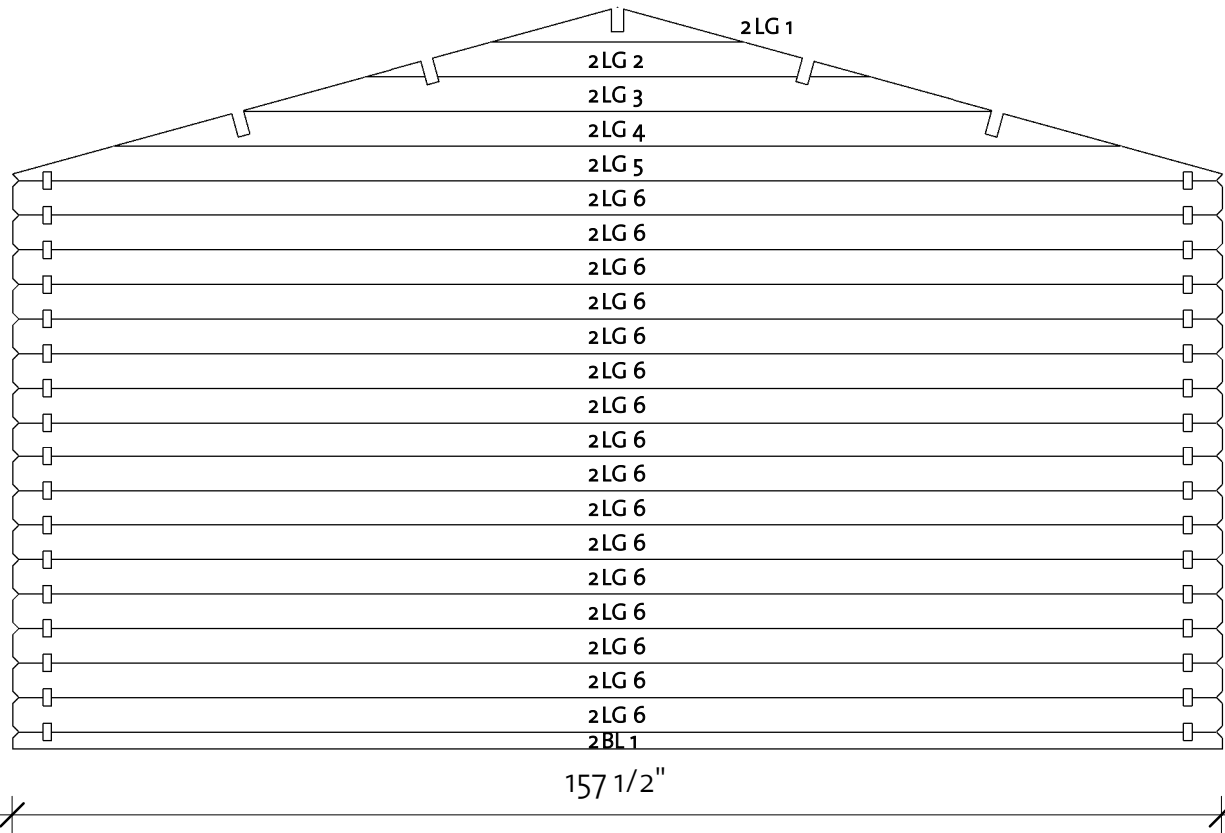

# Toronto 28 (149 5/8" x 110 1/4")

Wall A

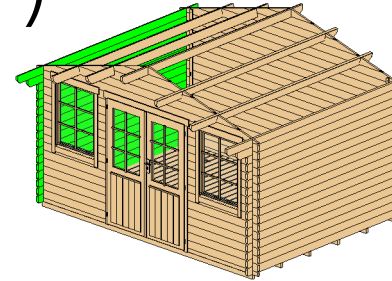

Wall A			
Mark	Profile	Count	Cut Length

ALG 1	28x114	15	118 1/8"
ALG 2	28x114	1	126"
ATL 1	28x114	1	137 3/4"

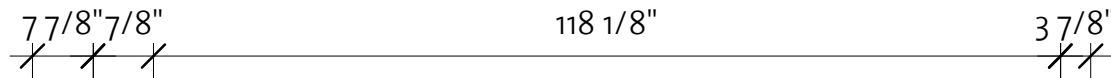
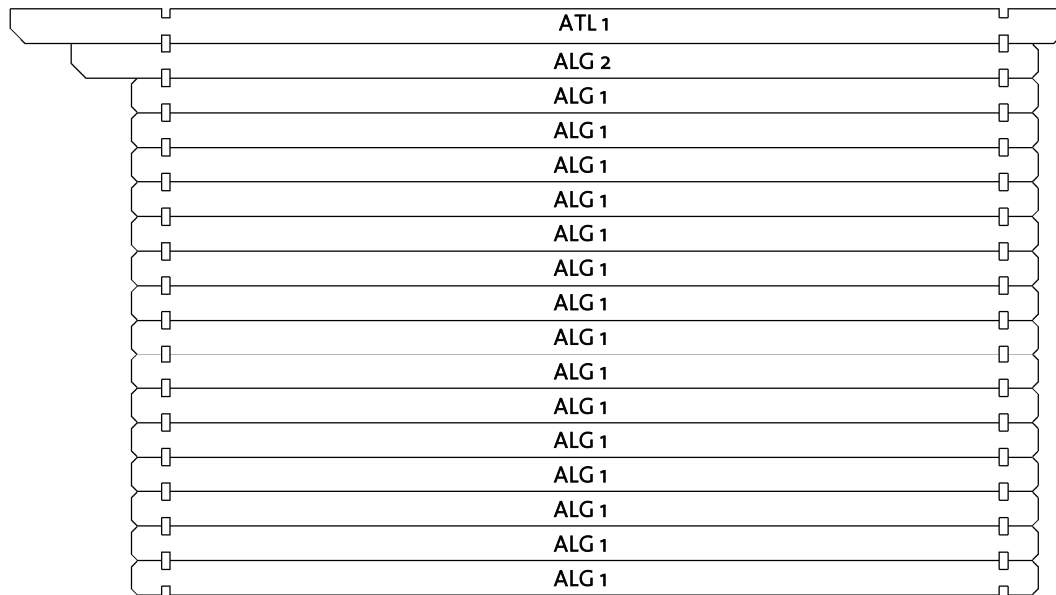

Log Profile Wall A	
Profile	Profile

28x114	
28x114	

# Toronto 28 (149 5/8" x 110 1/4")

Wall B

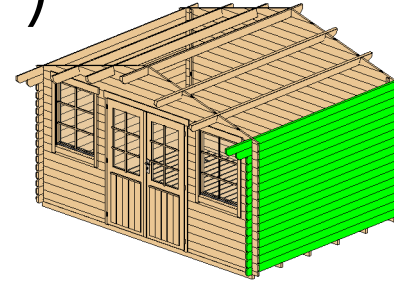

Wall B			
Mark	Profile	Count	Cut Length

BLG 1	28x114	15	118 1/8"
BLG 2	28x114	1	126"
BTL-1	28x114	1	137 3/4"

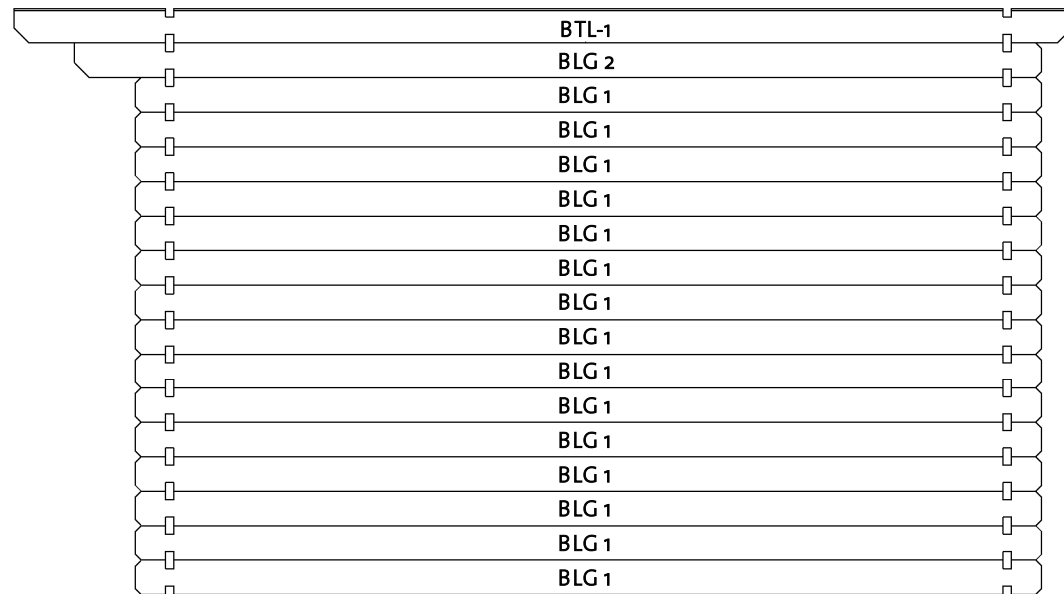





Log Profile Wall B	
Profile	images2

28x114	
28x114	

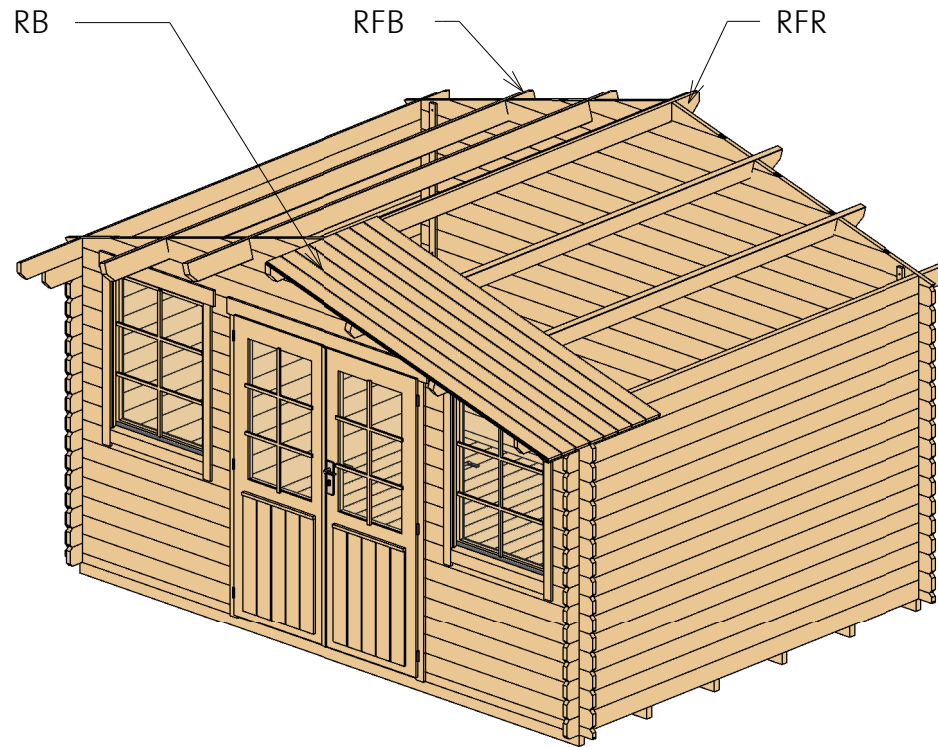
# Toronto 28 (149 5/8" x 110 1/4")

Roof 1



Roof				
Mark	Type	Profile	Count	Length
RFR	Ridge 40x120		1	137 3/4"
RFB	Beam 40x120		4	137 3/4"
RB	17x114		64	87 1/2"



# Toronto 28 (149 5/8" x 110 1/4")

Roof 2

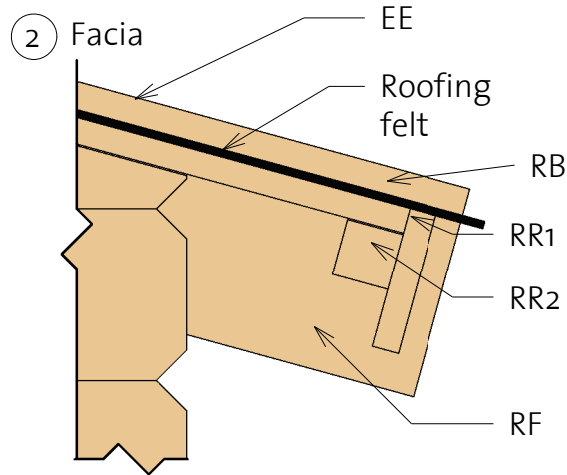
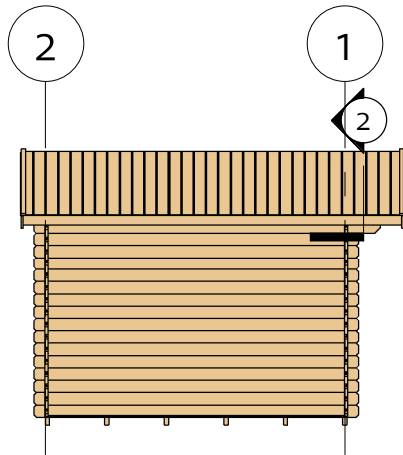

3 Roof Reinforcement

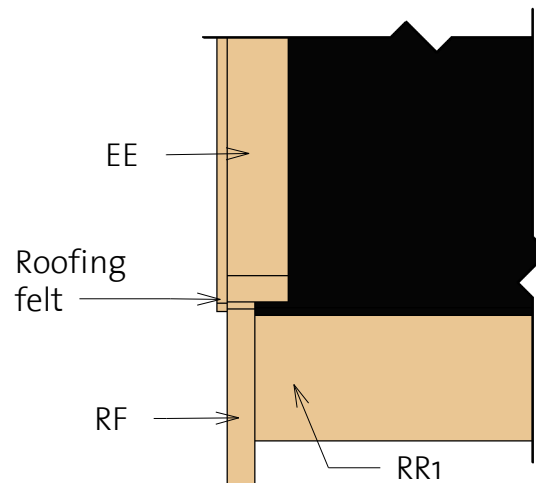
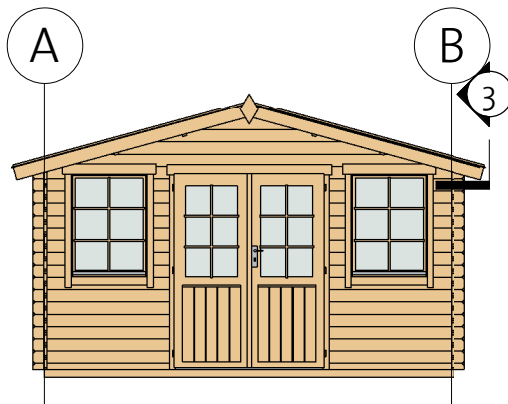

Fascia Schedule

Mark	Type	Profile	Count	Length
EE	Eave Edging 18x40		4	89"
RF	Roof Fascia 18x120		4	89"
RR1	Roof reinforcement 18x95		2	137 3/4"
RR2	Roof reinforcement 38x38		2	137 3/4"

# Toronto 28 (149 5/8" x 110 1/4")

Extras

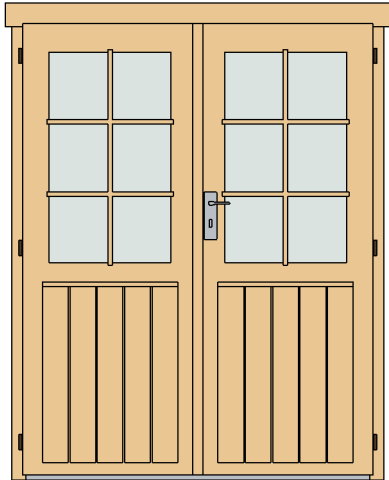

Door Schedule				
Model	Type	Width	Height	Count
BDD5R	Basic double door 5 right	56 1/8"	72 1/4"	1
DCB6	Door crossbar 6	--	--	2

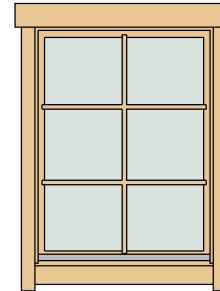

Window Schedule				
Model	Type	Width	Height	Count
BW1R	Basic window 1 right	30 1/8"	39"	1
BW1L	Basic window 1 left	30 1/8"	39"	1
WCB6	Window crossbar 6	--	--	2

Fasteners/Extras		
Name	Type	Count

Hitblock	300-400 mm	
Bolts	M8 x 60	12
Screws	5,0 x 70	15
nails	1,4 x 40	30
Screws	6,0 x 140	35
Screws	4,0 x 40	570



Type	Count	Length
Windboard 18x40	4	86 5/8"



Type	Count
Romb	2

# Toronto 28 (149 5/8"x110 1/4")

## List of all items 1

### Impregnated foundation beams

Mark	Type	Profile	Count	Length
------	------	---------	-------	--------

IFB	IFB 40x70		6	149 1/4"
-----	--------------	---	---	-------------

### Floor Schedule

Mark	Type	Profile	Count	Length
------	------	---------	-------	--------

FB	FB 17x114		34	107 7/8"
----	-----------	---	----	-------------

BB1	BB 20x40		2	149 5/8"
-----	-------------	---	---	-------------

BB2	BB 20x40		2	110 1/4"
-----	-------------	--	---	----------

### Roof

Mark	Type	Profile	Count	Length
------	------	---------	-------	--------

RFR	Ridge 40x120		1	137 3/4"
-----	-----------------	---	---	----------

RFB	Beam 40x120		4	137 3/4"
-----	----------------	---	---	----------

RB	17x114		64	87 1/2"
----	--------	---	----	---------

### Fascia Schedule

Mark	Type	Profile	Count	Length
------	------	---------	-------	--------

EE	Eave Edging 18x40		4	89"
----	----------------------	---	---	-----

RF	Roof Fascia 18x120		4	89"
----	-----------------------	---	---	-----

RR1	Roof reinforcement 18x95		2	137 3/4"
-----	--------------------------------	---	---	-------------

RR2	Roof reinforcement 38x38		2	137 3/4"
-----	--------------------------------	---	---	-------------

# Toronto 28 (149 5/8"x110 1/4")

## List of all items 2

Wall 1			
Mark	Profile	Count	Cut Length

1BL 1	28x57	2	50 3/8"
1LG 1	28x114	18	7 1/2"
1LG 2	28x114	18	12 5/8"
1LG 3 *	28x114	1	32 3/4"
1LG 4 *	28x114	1	65 1/2"
1LG 5	28x114	14	50 3/8"
1LG 6 *	28x114	1	97 1/2"
1LG 7 *	28x114	1	131"
1LG 8 *	28x114	1	157 1/2"

Wall 2			
Mark	Profile	Count	Cut Length

2BL 1	28x57	1	157 1/2"
2LG 1 *	28x114	1	32 3/4"
2LG 2 *	28x114	1	65 1/2"
2LG 3 *	28x114	1	97 1/2"
2LG 4 *	28x114	1	131"
2LG 5 *	28x114	1	157 1/2"
2LG 6	28x114	16	157 1/2"

\*Gable-delivered premounted



Wall A			
Mark	Profile	Count	Cut Length

ALG 1	28x114	15	118 1/8"
ALG 2	28x114	1	126"
ATL 1	28x114	1	137 3/4"

Wall B			
Mark	Profile	Count	Cut Length

BLG 1	28x114	15	118 1/8"
BLG 2	28x114	1	126"
BTL-1	28x114	1	137 3/4"

Log Profiles	
Profile	Profile

28x57	
28x114	

Log Profiles	
Profile	Profile

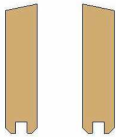
28x114	
--------	---