

Techn. Data: Hoby Nervion

Log length (W x D): 400 x 300 cm

Wall size(outside): 380 x 280 cm-Log thickness: 28 mm

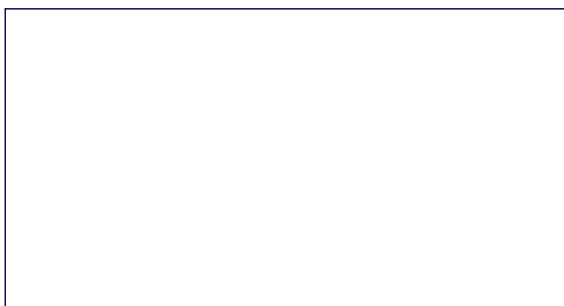

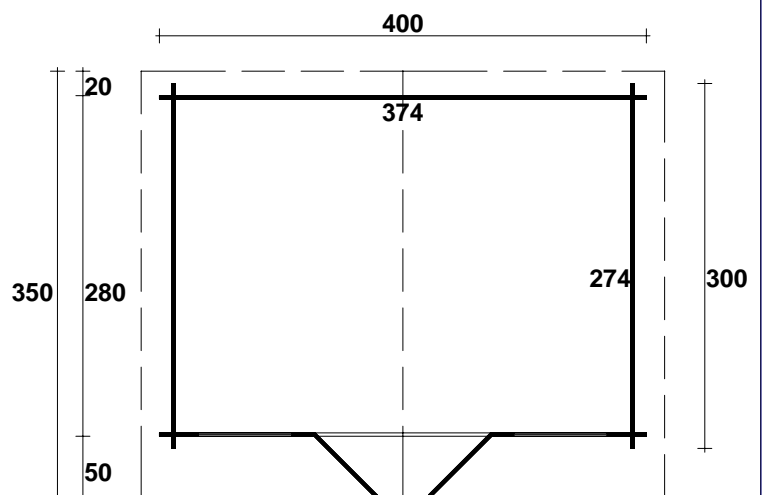



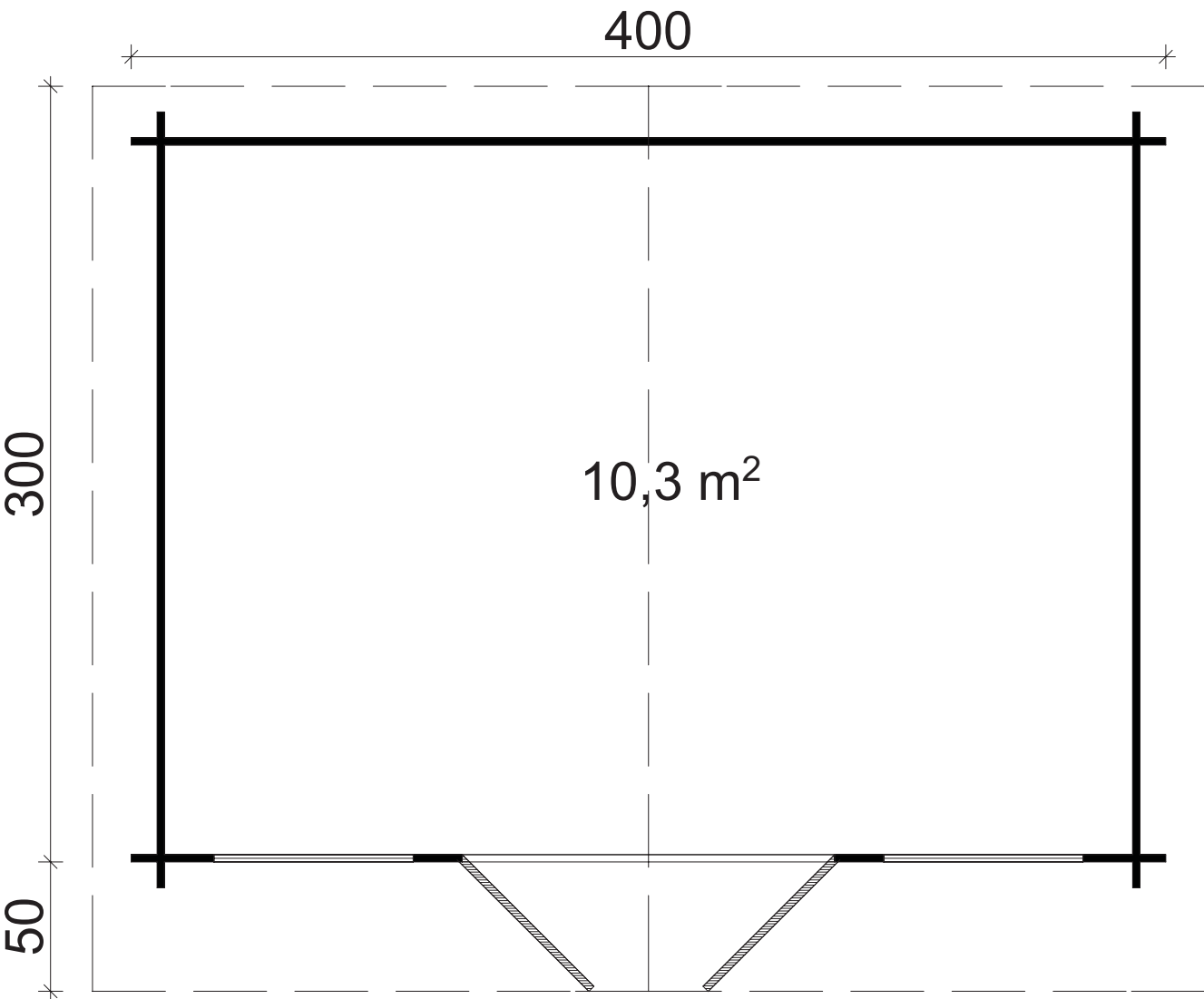



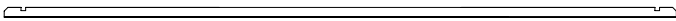

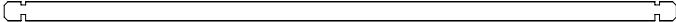

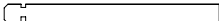

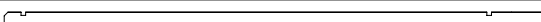

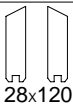

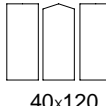
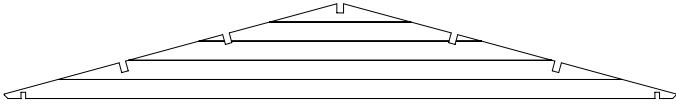

Note: All dimensions are approximate !

Nervion

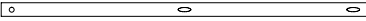

Hoby Nervion 400 x 300 cm

| Nr | Description | Profile mm | Length mm | Quantity |
|----|--|--|------------|----------|
| 1 | Foundation  | 45x70 | 3800 | 6 |
| 2 |  |  57 | 4000 | 2 |
| 3 |  |  114 | 4000 | 16 |
| 4 |  | | 3000 | 30 |
| 5 |  | | 1280 | 14 |
| 6 |  | | 320 | 18 |
| 7 |  | | 190 | 18 |
| 8 |  | | 3200 | 2 |
| 9 |  |  28x120 | 3500 | 2(1+1) |
| 10 | Purlin  |  40x120 | 3500 | 5(4+1) |
| 11 | Gable  |  114 | 4000 | 2 |
| 12 | Door ca. 1425 x1775mm | | | 1 |
| 13 | Window ca. 765 x990mm | | | 2 |
| 14 | Roofing felt | | | Roll |
| 15 | Roof board | Vers. 1 >  18x88 | 2300 | 80+2 |
| | | Vers. 2 >  18x110 | 2300 | 64+2 |
| 16 | Floor board | Vers. 1 >  18x88 | 2740 | 43+1 |
| | | Vers. 2 >  18x110 | 2740 | 34+1 |
| 17 | Facia board  | 18x110 | 2340 | 4 |
| 18 | Eave edging | 16x35 | 2340 | 4 |
| 19 | Roof edge reinforcement | 18x90 | 3500 | 2 |
| 20 | Roof edge reinforcement | 28x28 | 1750 | 4 |
| 21 | Diamond  | | | 2 |
| 22 | Screws 4,0 x 40 | | | 1 bag |
| 23 | Nails 2,5 x 50 | | | 1 bag |
| 24 | Roofing nails 3,0 x 15 | | | 1 bag |
| 25 | Storm braces  | | 1900 | 4 |
| 26 | Baseboard  | | ca. 13,0 m | |
| 27 | Bolt M 8 x 60, nut, washer | | | 12 |
| 28 | Hit block | | 300-400 | 3 |

Hoby Nervion 400 x300 cm

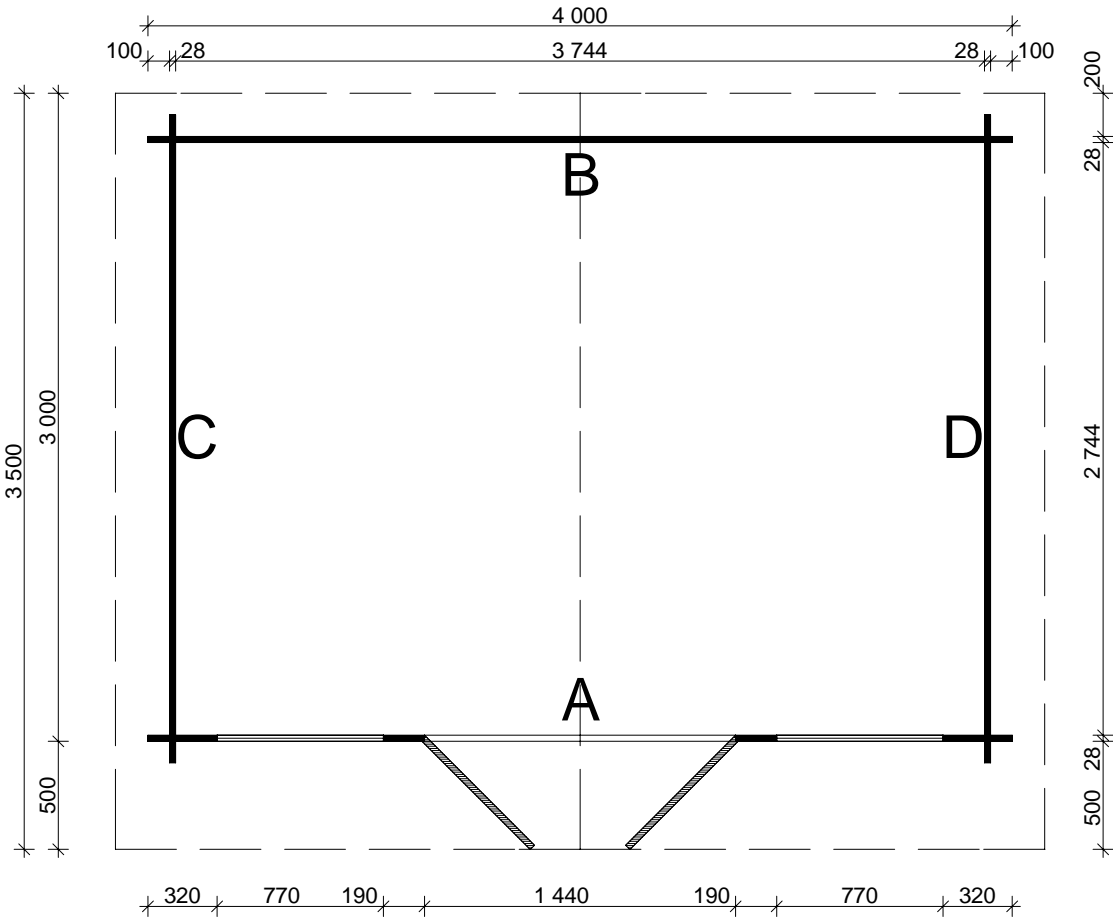

Hoby Nervion 400 x300 cm

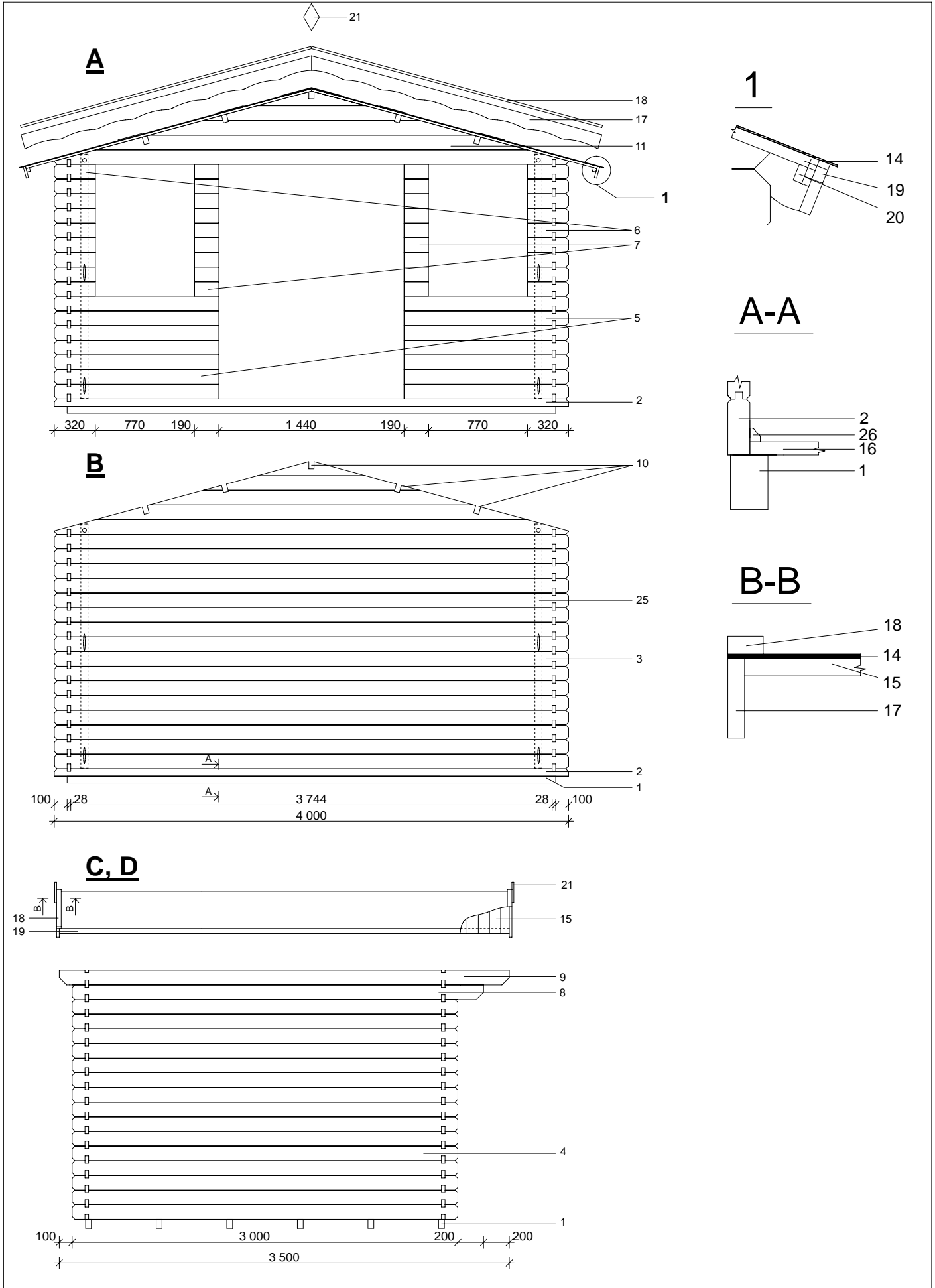

Hoby Nervion 400 x300 cm

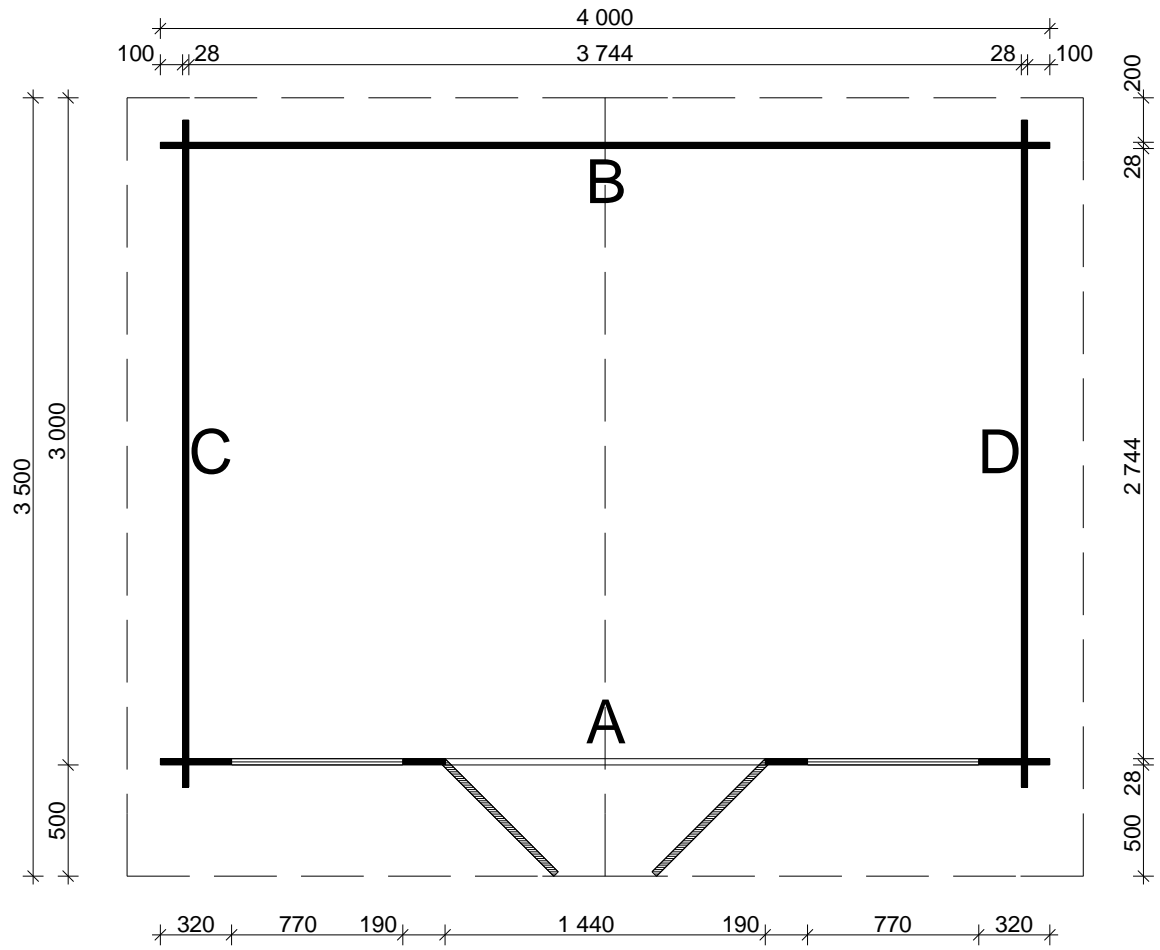





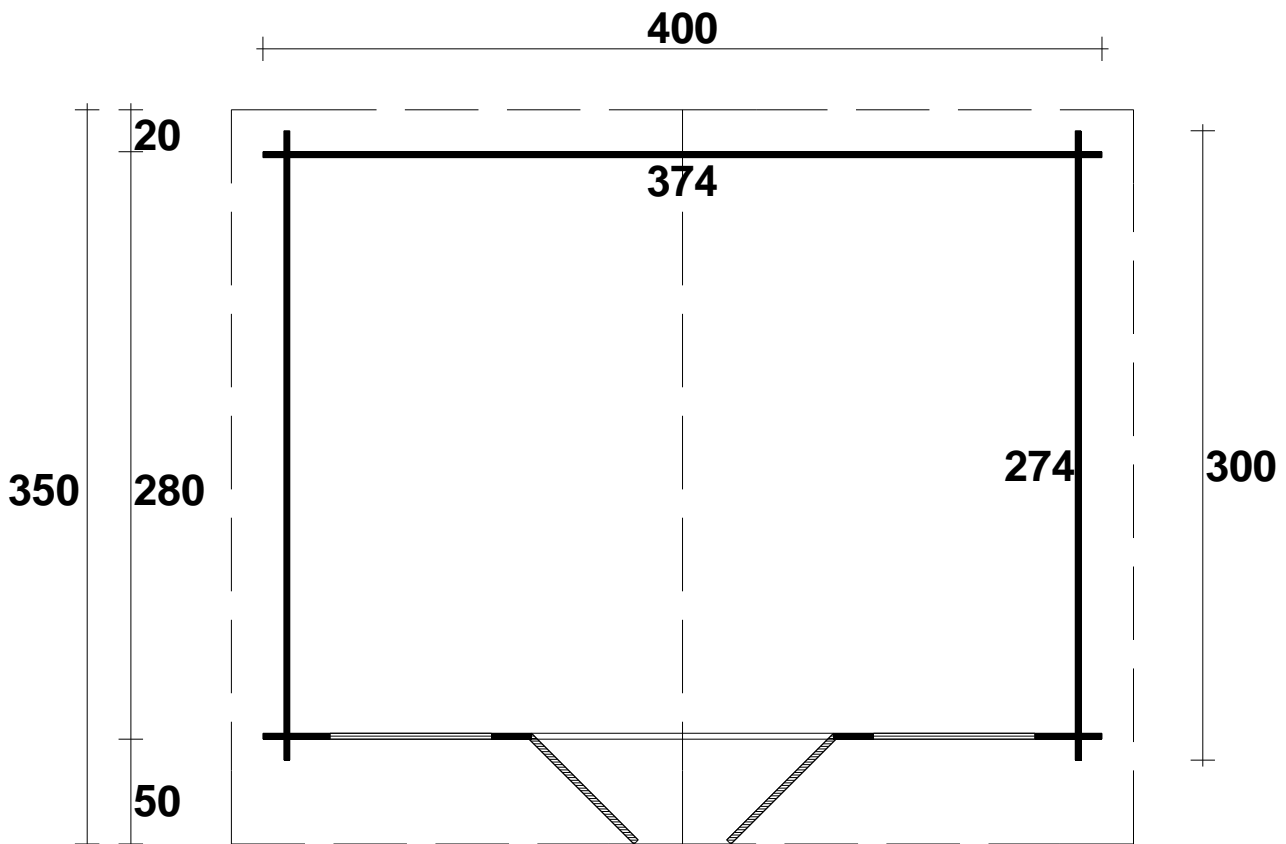



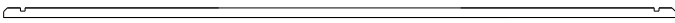

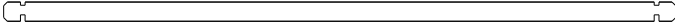
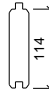

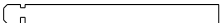

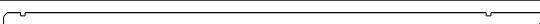

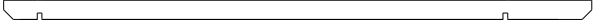
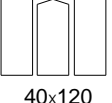
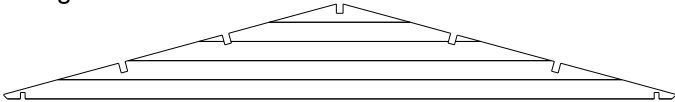

Hoby Nervion

400 x 300 cm - 28 mm

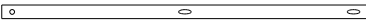

Hoby Nervion 400 x 300 cm

| Nr | Listado de piezas | Ancho/Grueso mm | Largo mm | Cantidad |
|----|--|---|------------|-----------|
| 1 | Fundament  | 45x70 | 3800 | 6 |
| 2 |  |  | 4000 | 2 |
| 3 |  |  | 4000 | 16 |
| 4 |  | | 3000 | 30 |
| 5 |  | | 1280 | 14 |
| 6 |  | | 320 | 18 |
| 7 |  | | 190 | 18 |
| 8 |  | | 3200 | 2 |
| 9 | Vigas laterales  |  28x120 | 3500 | 2(1+1) |
| 10 | Vigas centrales  |  40x120 | 3500 | 5(4+1) |
| 11 | Triangulo  |  | 4000 | 2 |
| 12 | Puerta ca. 1425 x1775mm | | | 1 |
| 13 | Ventana ca. 765 x990mm | | | 2 |
| 14 | Dela asfaltica | | | Rolle |
| 15 | Tarima tejado | Vers. 1 >  | 2300 | 80+2 |
| | | Vers. 2 >  | 2300 | 64+2 |
| 16 | Tabla de suelos | Vers. 1 >  | 2740 | 43+1 |
| | | Vers. 2 >  | 2740 | 34+1 |
| 17 | Remate delantero  | 18x110 | 2340 | 4 |
| 18 | Remate tela asfaltica | 16x35 | 2340 | 4 |
| 19 | Remate lateral | 18x90 | 3500 | 2 |
| 20 | Liston remate lateral | 28x28 | 1750 | 4 |
| 21 | Embellecedor central  | | | 2 |
| 22 | Tirafondos 4,0 x 40 | | | 1 Paquete |
| 23 | Clavos tarima 2,5 x 50 | | | 1 Paquete |
| 24 | Clavos tela asfaltica 3,0 x 15 | | | 1 Paquete |
| 25 | Liston  | | 1900 | 4 |
| 26 | Liston |  | ca. 13,0 m | |
| 27 | Saeta M 8 x 60, nuez, arandela | | | 12 |
| 28 | Maderas para golpear | | 300-400 | 3 |

Hoby Nervion 400 x300 cm

