

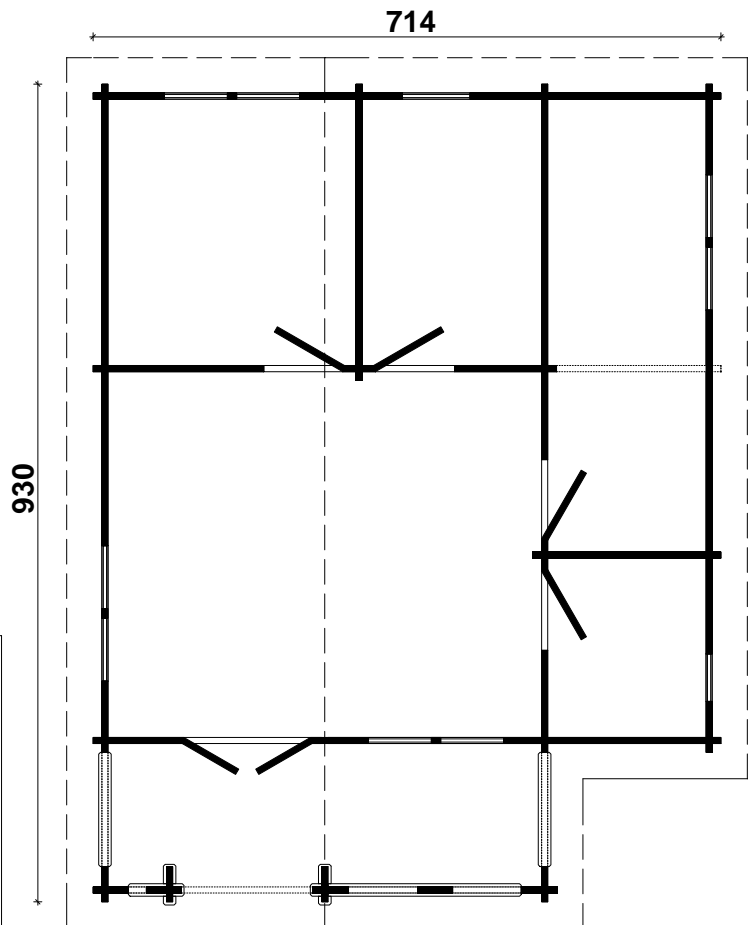

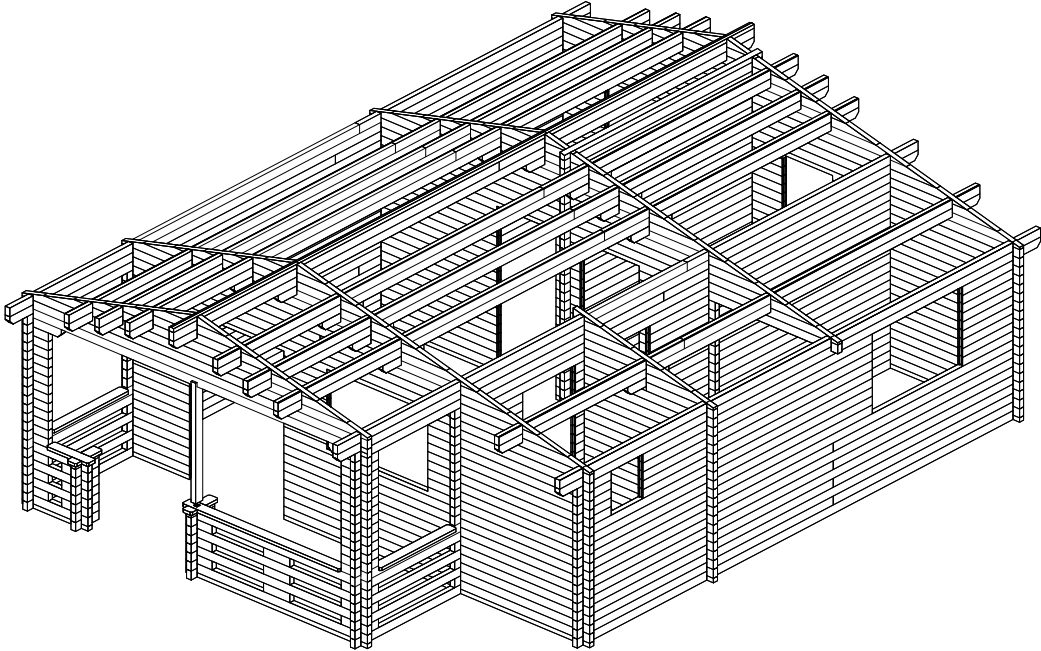









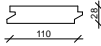

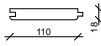

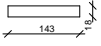

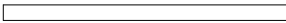
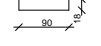
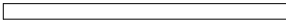
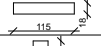
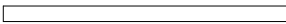



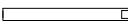



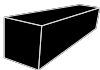

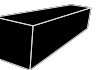
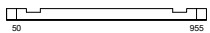
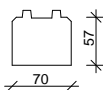

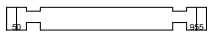

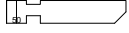

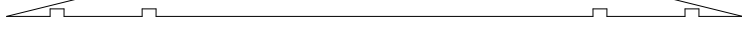
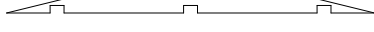
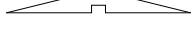
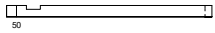
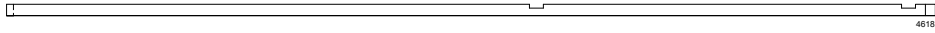

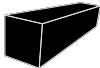

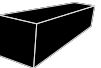
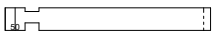
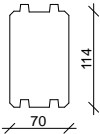
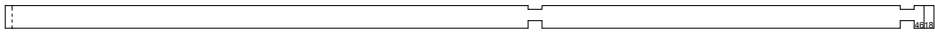
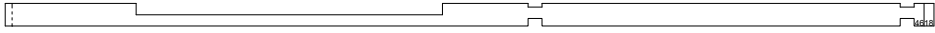
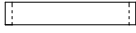
Amarillo



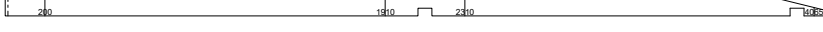

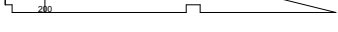
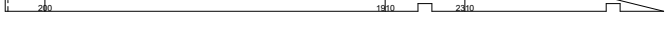

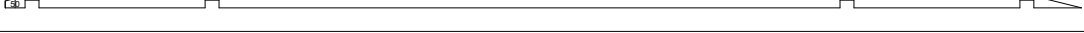
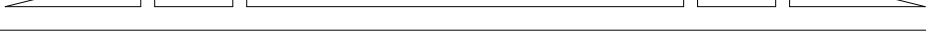
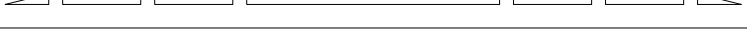
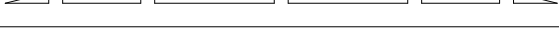
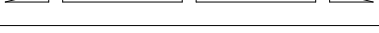







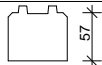

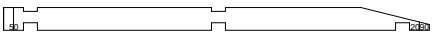
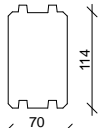
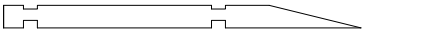



OSM Wall 694 x 910 cm

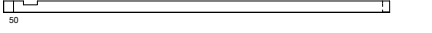

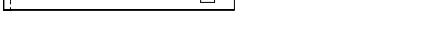

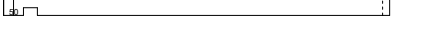





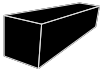

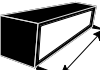
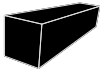

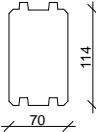
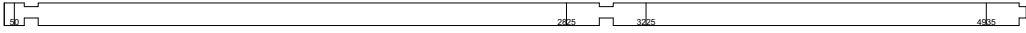
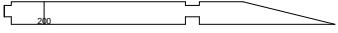

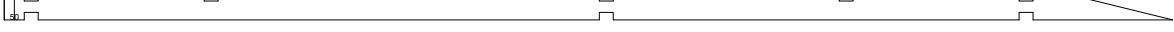

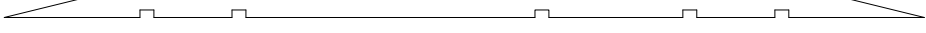

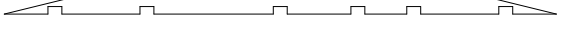
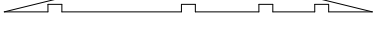
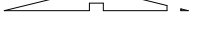
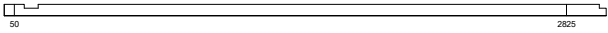



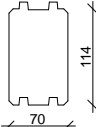

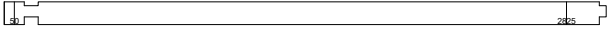







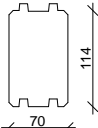

| Nr. |  |  mm |  mm |  x |
|-------|--|--|--|---|
| EX01 | Fundament | 70 x 60 | 4900 | 7 |
| EX02 | | | 2010 | 3 |
| EX03 | | | 1700 | 2 |
| EX04 | | | 4145 | 15 |
| EX05 | | | 3015 | 16 |
| EX06 | | | 463 | 2 |
| EX07 | Fußbodenbretter |  | 4928 / 4998 | 20 / 18+1 |
| EX08 | | | 2818 | 28 |
| EX09 | | | 2038 | 28 |
| EX10 | | | 1798 | 66 |
| EX11 | Terrassendielen |  | 1700/1630 | 16/34 |
| EX12 | Dachbretter |  | 3020 | 106 |
| EX13 | | | 4945 | 75+1 |
| EX14 | Giebelblende  |  | 5000 | 1 |
| EX15 | | | 3070 | 3 |
| EX16 | Giebelblende  | | 1975 | 1 |
| EX17 | Giebelabschlussbrett  |  | 5000 | 1 |
| EX18 | | | 3070 | 3 |
| EX19 | | | 1975 | 1 |
| EX20* | Traufenbrett  |  | 4950 | 4 |
| EX21* | Traufenleiste  | |  | 4950 |
| EX22 | Raute |  | | 2 |
| EX23* | Fußleisten |  | ca. 63,5 m | |
| EX24 | Dachpappe | | -- | -- |
| EX25 | | | -- | -- |
| EX26 | Pfoste  | 70 x 120 | 1540 | 1 |
| EX27 | Stütze |  | | 1 |
| EX28 | Gewindestangen | ∅ 10 | 2310 | 3 |
| EX29 | | | 2775 | 5 |
| EX30 | Mutter, Scheibe | | | 16 |
| EX31 | Dübel | ∅ 16 | 150 | 180 |
| EX32 | Handlauf  | 40 x 143 | 1300 | 2 |
| EX33 | | | 635 | 1 |
| EX34 | | | 2400 | 1 |
| EX35 | | | 105 | 2 |
| EX36 | Handlauf  | | 220 | 2 |
| EX37 | Winkel | | | 4 |
| EX38 | Schrauben 4,0 x 40 | | | 1 Beutel |
| EX39 | Schrauben 5,0 x 70 | | | 1 Beutel |
| EX40 | Schrauben 5,0 x 120 | | | 1 Beutel |
| EX41 | Nägel 2,2 x 50; 2,5 x 70; 1,4 x 35 | | | 1 Beutel |
| EX42 | Schlaghölzer | 70 x 114 | 300-400 | |

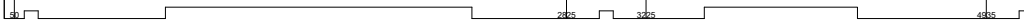



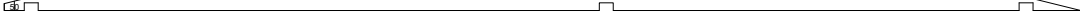



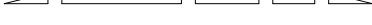
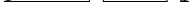

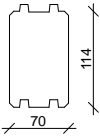
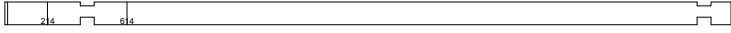

| Nr. |  |  mm |  mm |  x | |
|------------|--|--|--|---|------|
| A01 |  |  | 1005 | 1 | |
| A02 |  | | | 2770 | 1 |
| A03 |  |  | 1005 | 4 | |
| A04 |  | | | 2770 | 4 |
| A05 |  | | | 400 | 38 |
| A06 |  | | | 400 | 3 |
| A07 |  | | | 600 | 2 |
| A08 |  | | | 5270 | 2 |
| A09 |  | | | 5270 | 1 |
| A10 |  | | | 4624 | 1 |
| A11 |  | | | 3699 | 1 |
| A12 |  | | | 2774 | 1 |
| A13 |  | | | 1849 | 1 |
| A14 |  | | | 925 | 1 |
| B01 |  | |  | 1033 | 1 |
| B02 |  | | | | 4668 |
| | | | | | |

| Nr. |  |  mm |  mm |  x |
|------------|--|--|--|---|
| B03 |  |  | 1033 | 18 |
| B04 |  | | 4668 | 9 |
| B05 |  | | 4668 | 1 |
| B06 |  | | 658 | 8 |
| B07 |  | | 2470 | 8 |
| B08 |  | | 5135 | 1 |
| B09 |  | | 2005 | 1 |
| B10 |  | | 3025+14 | 2 |
| B11 |  | | 4115 | 1 |
| B12 |  | | 5135 | 1 |
| B13 |  | | 1662 | 1 |
| B14 |  | | 3309 | 1 |
| B15 |  | | 5872 | 1 |
| B16 |  | | 5409 | 1 |
| B17 |  | | 4624 | 1 |
| B18 |  | | 3699 | 1 |
| B19 |  | | 2774 | 1 |
| B20 |  | | 1849 | 1 |
| B21 |  | | 925 | 1 |

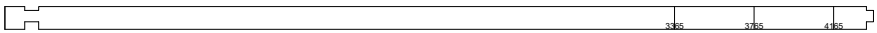
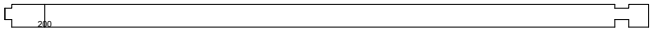

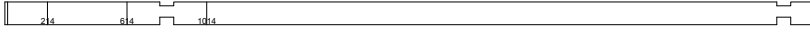
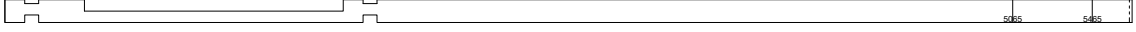
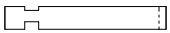
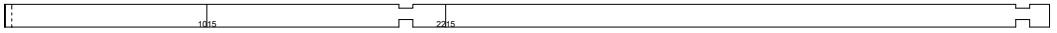

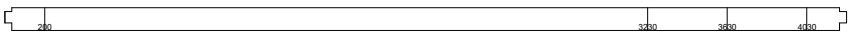
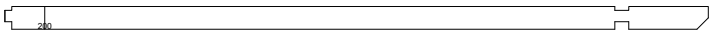
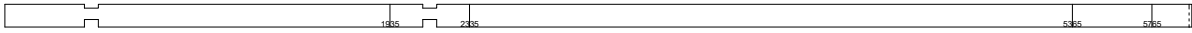
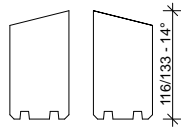



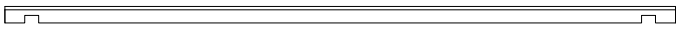





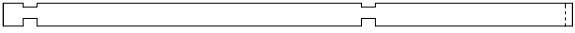
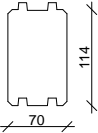

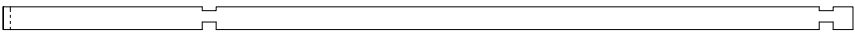
| Nr. |  |  mm |  mm |  x | |
|-----|--|--|--|---|---|
| C01 |  |  | 2140 | 1 | |
| C02 |  | | 2140 | 18 | |
| C03 |  | | 2140 | 1 | |
| C04 |  | |  | 2140 | 1 |
| C05 |  | | | 1797 | 1 |
| C06 |  | | | 1334 | 1 |
| C07 |  | | | 872 | 1 |
| C08 |  | | 409 | 1 | |
| D01 |  |  | 1940 | 1 | |
| D02 |  | | 370 | 1 | |
| D03 |  | | 1160 | 1 | |
| D04 |  |  | 1940 | 18 | |
| D05 |  | | 370 | 18 | |
| D06 |  | | 1160 | 18 | |
| D07 |  | | 4735 | 1 | |
| D08 |  | | 2405+14 | 1 | |
| D09 |  | | 3025 | 2 | |

| Nr. |  |  mm |  mm |  x |
|------------|--|--|--|---|
| D10 |  |  | 4115 | 1 |
| D11 |  | | 5135 | 1 |
| D12 |  | | 1662 | 1 |
| D13 |  | | 3309 | 1 |
| D14 |  | | 5872 | 1 |
| D15 |  | | 5409 | 1 |
| D16 |  | | 4624 | 1 |
| D17 |  | | 3699 | 1 |
| D18 |  | | 2774 | 1 |
| D19 |  | | 1849 | 1 |
| D20 |  | 925 | 1 | |
| E01 |  |  | 3025 | 1 |
| E02 |  | | 4115 | 1 |
| E03 |  |  | 5135 | 6 |
| E04 |  | | 2005 | 6 |
| E05 |  | | 3025 | 6 |
| E06 |  | | 4115 | 4 |

| Nr. |  |  mm |  mm |  x | |
|-----|--|--|--|---|--|
| E07 |  |  | 3025 | 1 | |
| E08 |  | | 4115 | 1 | |
| E09 |  | | 810 | 8 | |
| E10 |  | | 1168 | 8 | |
| E11 |  | | 2852 | 8 | |
| E12 |  | | 5135 | 1 | |
| E13 |  | | 4115 | 1 | |
| E14 |  | | 1662 | 1 | |
| E15 |  | | 3309 | 1 | |
| E16 |  | | 5872 | 1 | |
| E17 |  | | 5409 | 1 | |
| E18 |  | | 4624 | 1 | |
| E19 |  | | 3699 | 1 | |
| E20 |  | | 2774 | 1 | |
| E21 |  | | 1849 | 1 | |
| E22 |  | | 925 | 1 | |
| | | | | | |
| | | | | | |

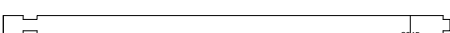
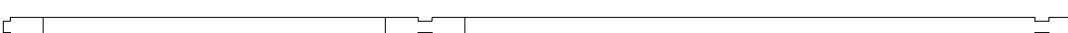
| Nr. |  |  mm |  mm |  × | |
|-----|--|--|--|---|--------|
| 101 |  |  | 5665 | 2 | |
| 102 |  | | 3635+14 | 4 | |
| 103 |  | | 400 | 16 | |
| 104 |  | | 4365 | 6 | |
| 105 |  | | 3235 | 6 | |
| 106 |  | | 5265 | 3 | |
| 107 |  | | 4035+14 | 3 | |
| 108 |  | | 5665 | 1 | |
| 109 |  | | 810 | 9 | |
| 110 |  | | 5250 | 9 | |
| 111 |  | | 3965 | 1 | |
| 112 |  | | 2135 | 1 | |
| 113 |  | | 4230 | 1 | |
| 114 |  | | 3535 | 1 | |
| 115 |  | |  | 5965 | 1(1+0) |
| 116 |  | | | 3935+14 | 1(1+0) |
| | | | | | |
| | | | | | |

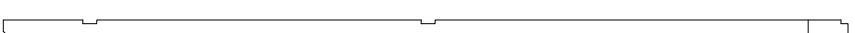
| Nr. |  |  mm |  mm |  x |
|-----|---|--|--|---|
| 201 |  |  | 400 | 7 |
| 202 |  |  | 400 | 1 |
| | | | | |
| 301 |  |  | 400 | 7 |
| 302 |  |  | 400 | 1 |
| | | | | |
| 401 |  |  | 3370 | 28 |
| 402 |  |  | 3370 | 1(0+1) |
| | | | | |
| | | | | |
| | | | | |
| | | | | |

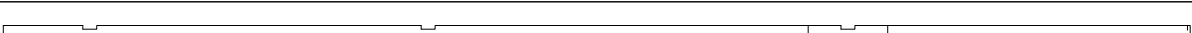
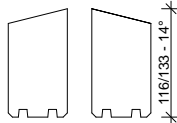
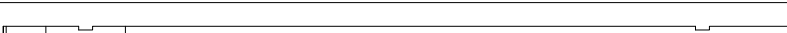
| Nr. |  |  mm |  mm |  x | |
|-----|--|--|--|---|--------|
| 501 |  |  | 2860 | 4 | |
| 502 |  | | 370 | 19 | |
| 503 |  | | 4270 | 19 | |
| 504 |  | | 400 | 16 | |
| 505 |  | | 1160 | 14 | |
| 506 |  | | 2860 | 1 | |
| 507 |  | | 4365 | 1 | |
| 508 |  | | 3235 | 1 | |
| 509 |  | | 2245 | 1 | |
| 510 |  | | 5355 | 1 | |
| 511 |  | | 5265 | 1 | |
| 512 |  | | 4035+14 | 1 | |
| 513 |  | | 4245 | 1 | |
| 514 |  | | 5655 | 1 | |
| 515 |  | |  | 5965 | 1(0+1) |
| 516 |  | | | 3935+14 | 1(0+1) |
| | | | | | |
| | | | | | |

| Nr. |  |  mm |  mm |  x |
|------|--|--|--|---|
| DB01 |  |  | 700 | 15 |
| DB02 |  | | 2135 | 7 |
| DB03 |  | | 4230 | 7 |
| DB04 |  | | 3535 | 7 |
| DB05 |  | | 2545 | 1 |
| DB06 |  | | 5655 | 1 |
| DB07 |  | | 5565 | 1 |
| DB08 |  | | 4335+14 | 1 |
| DB09 |  | |  | 2135 |
| DB10 |  | 4230 | | 1 |
| DB11 |  | 3535 | | 1 |
| DB12 |  |  | 5565 | 6(3+3) |
| DB13 |  | | 4335+14 | 6(3+3) |
| DB14 |  | | 3145+14 | 1(0+1) |
| DB15 |  | | 5055 | 1(0+1) |
| | | | | |
| | | | | |
| | | | | |

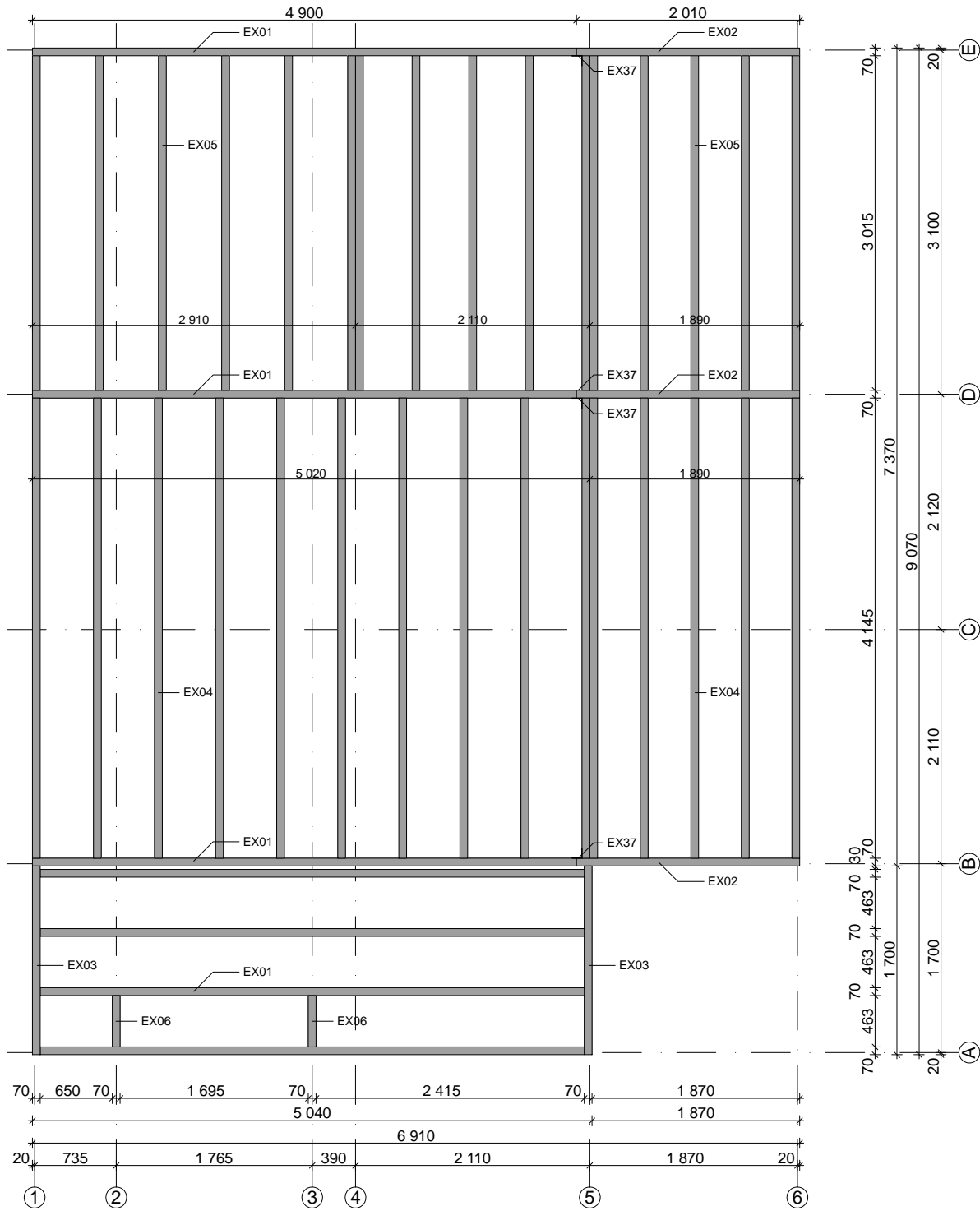

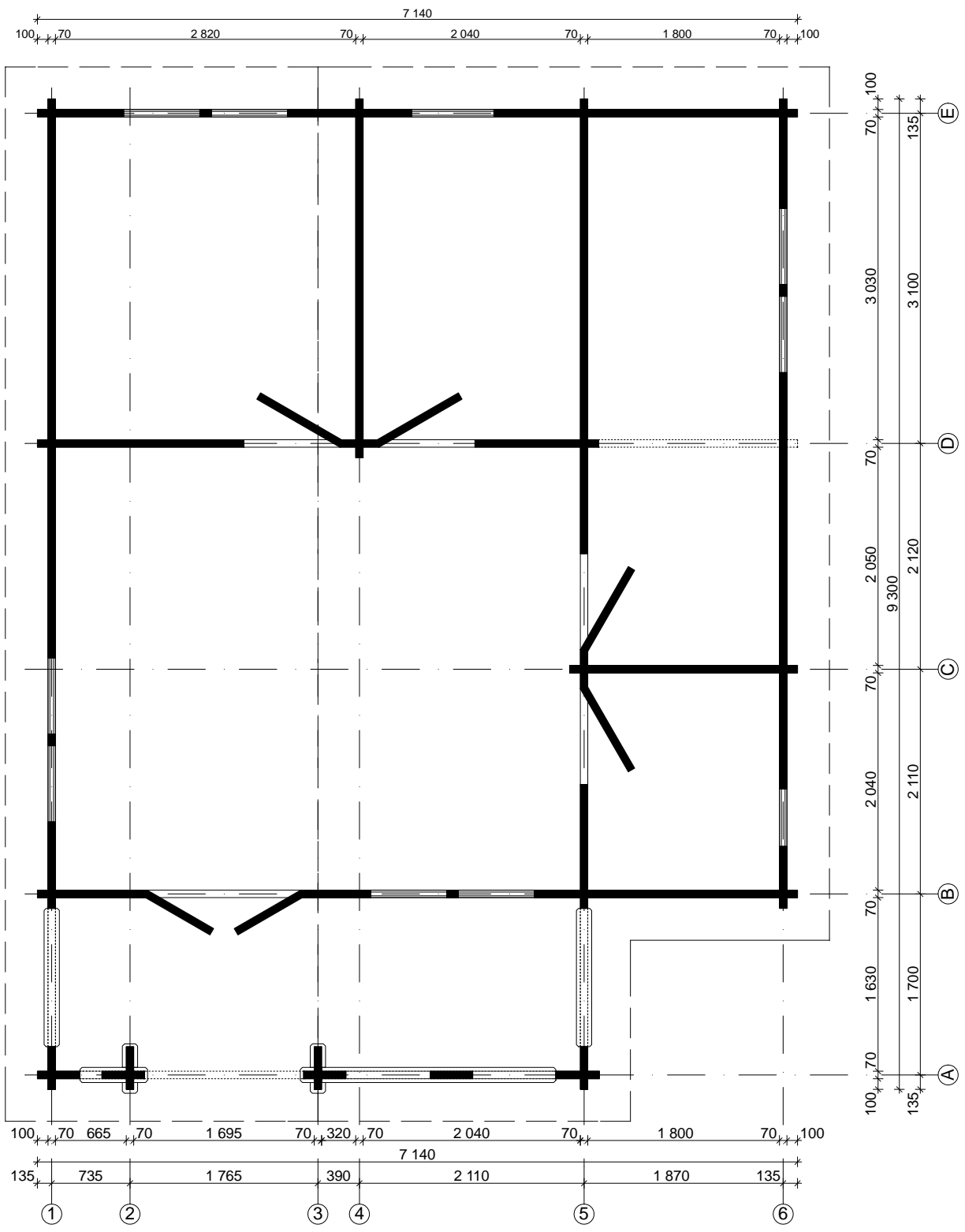

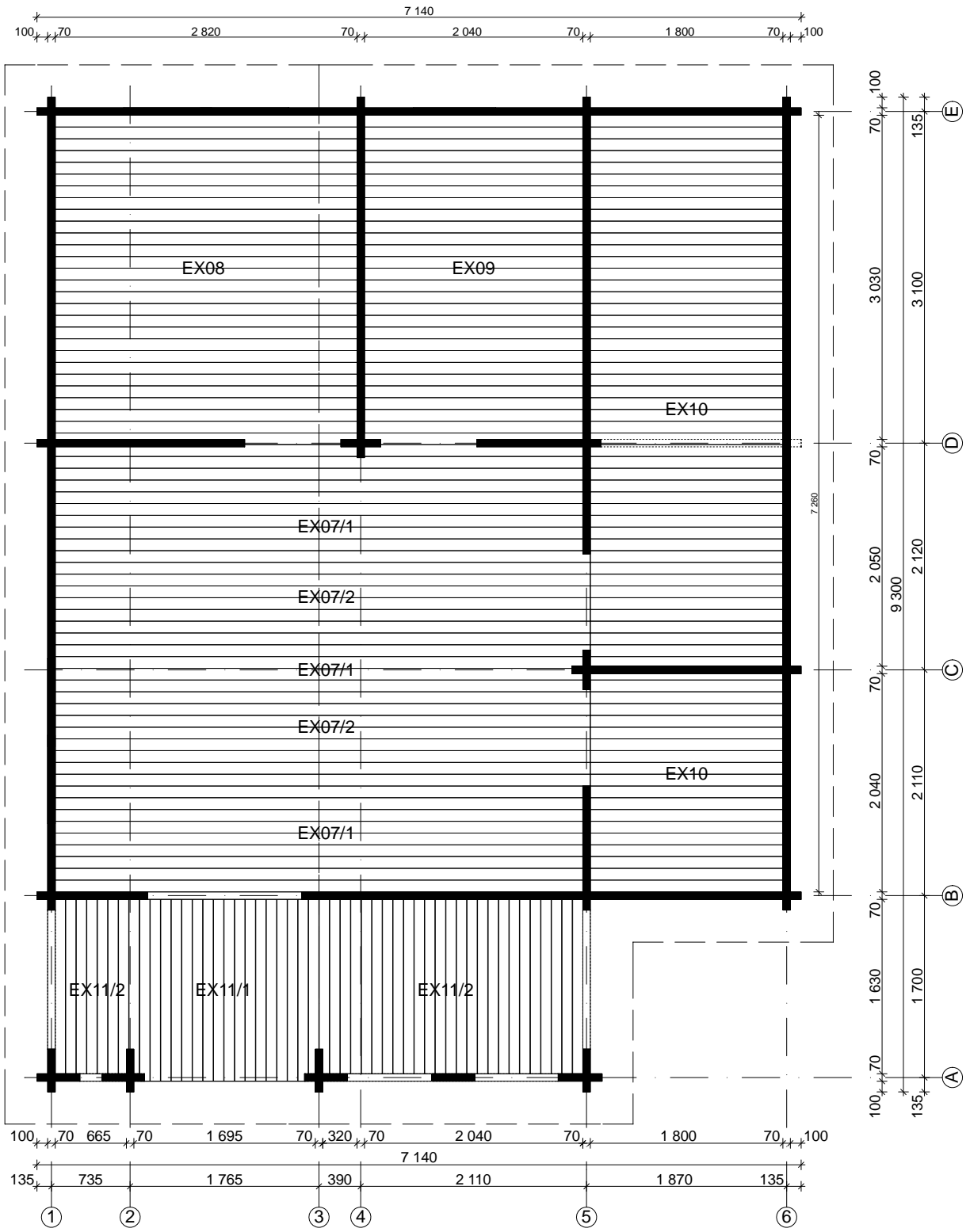

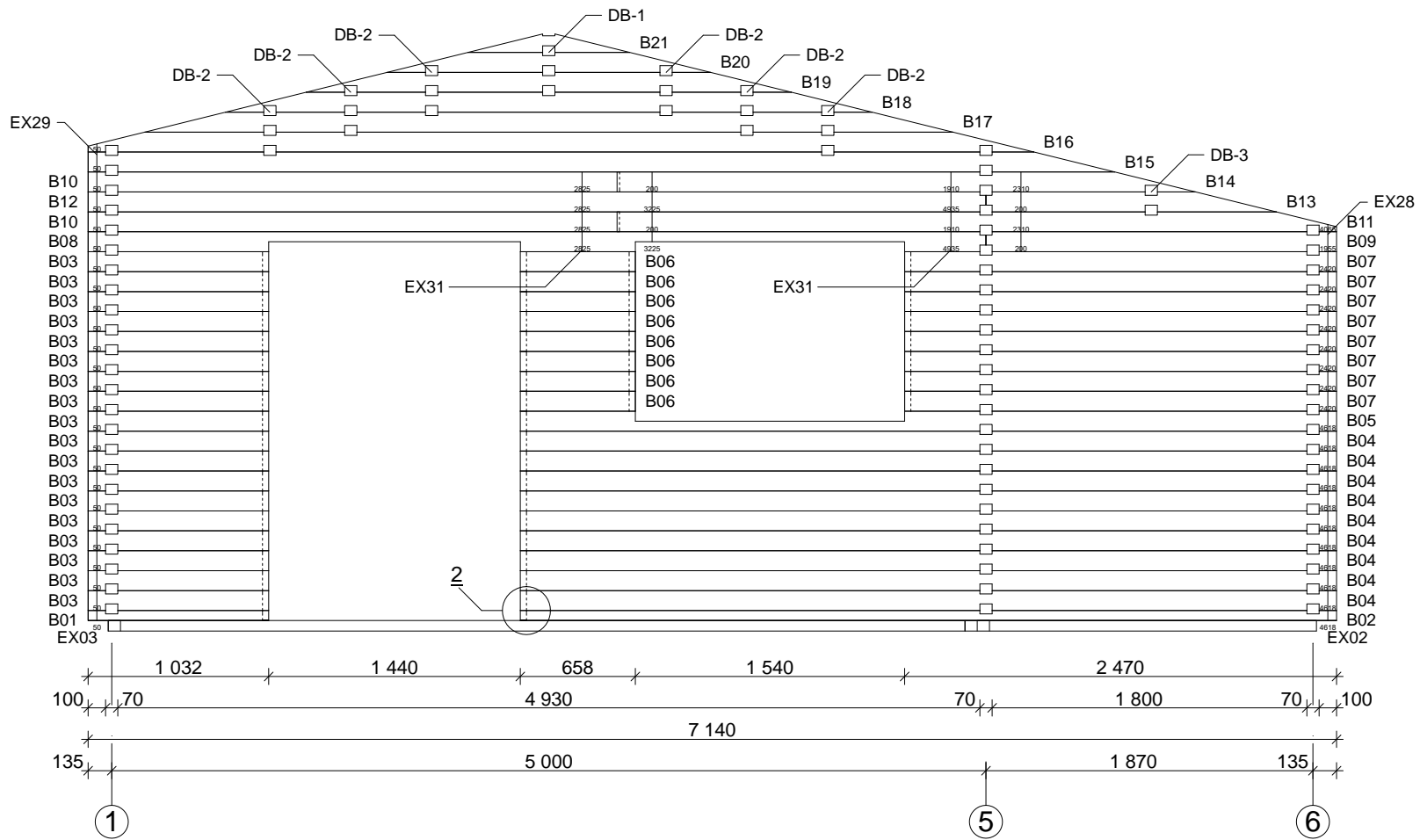

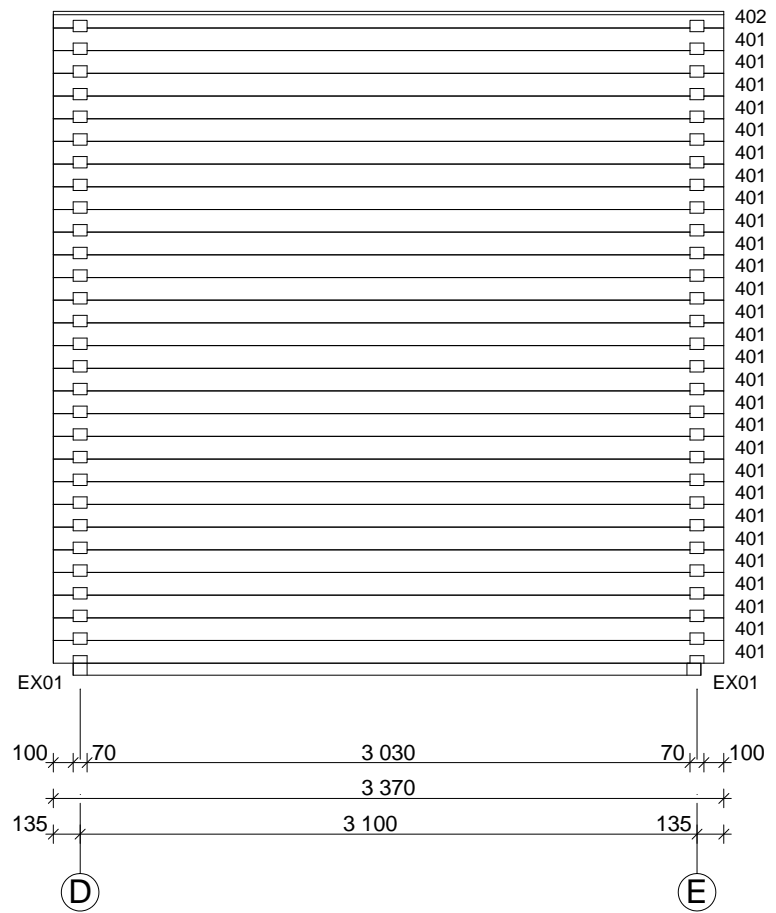
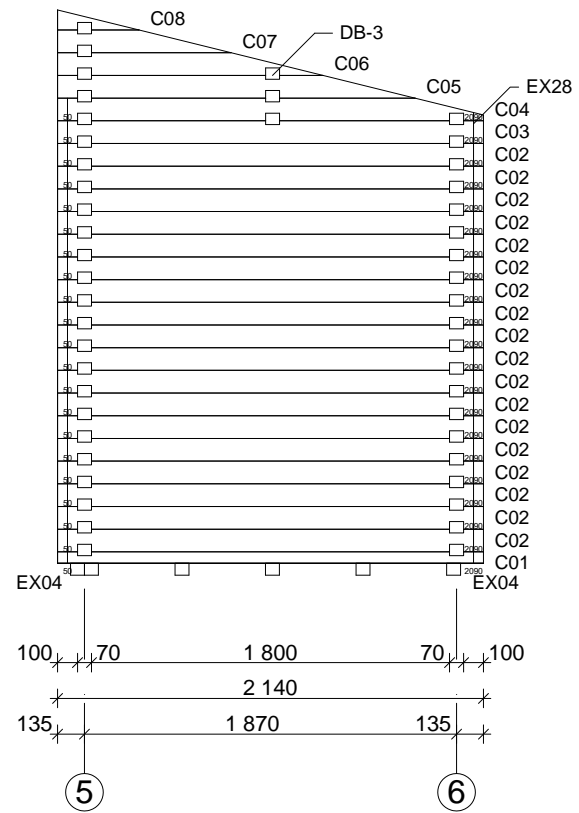

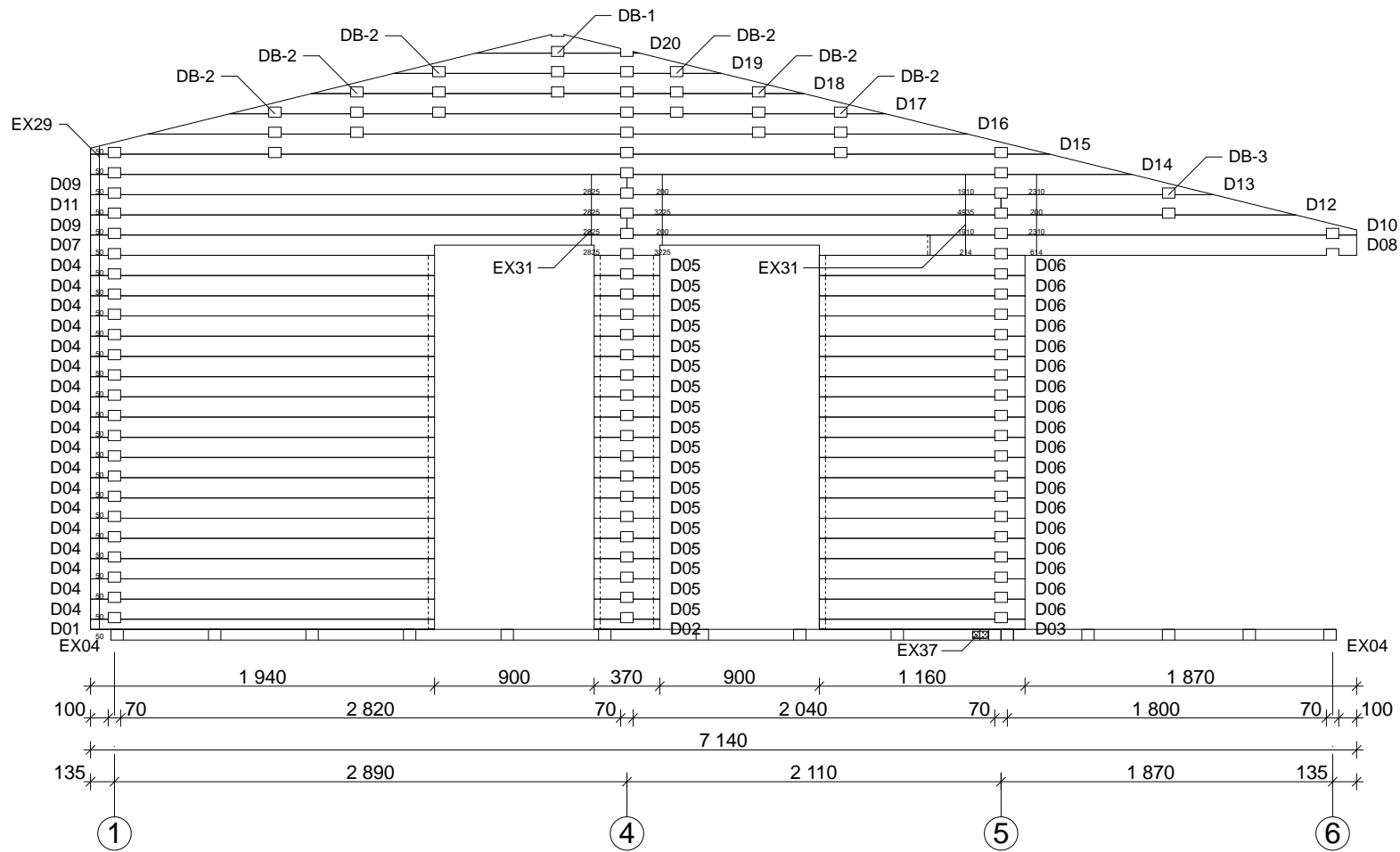

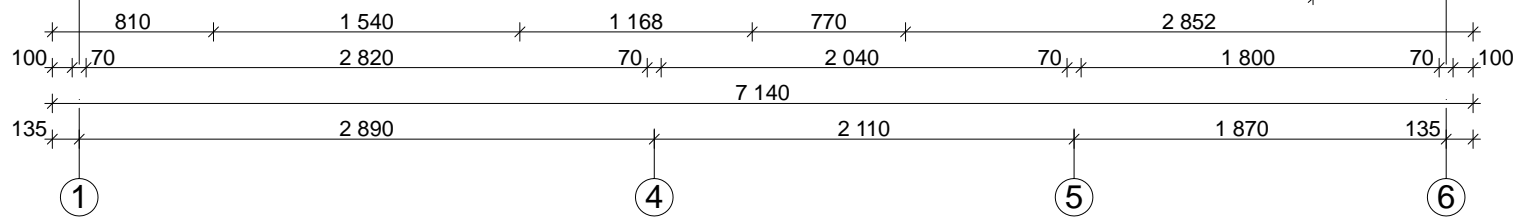
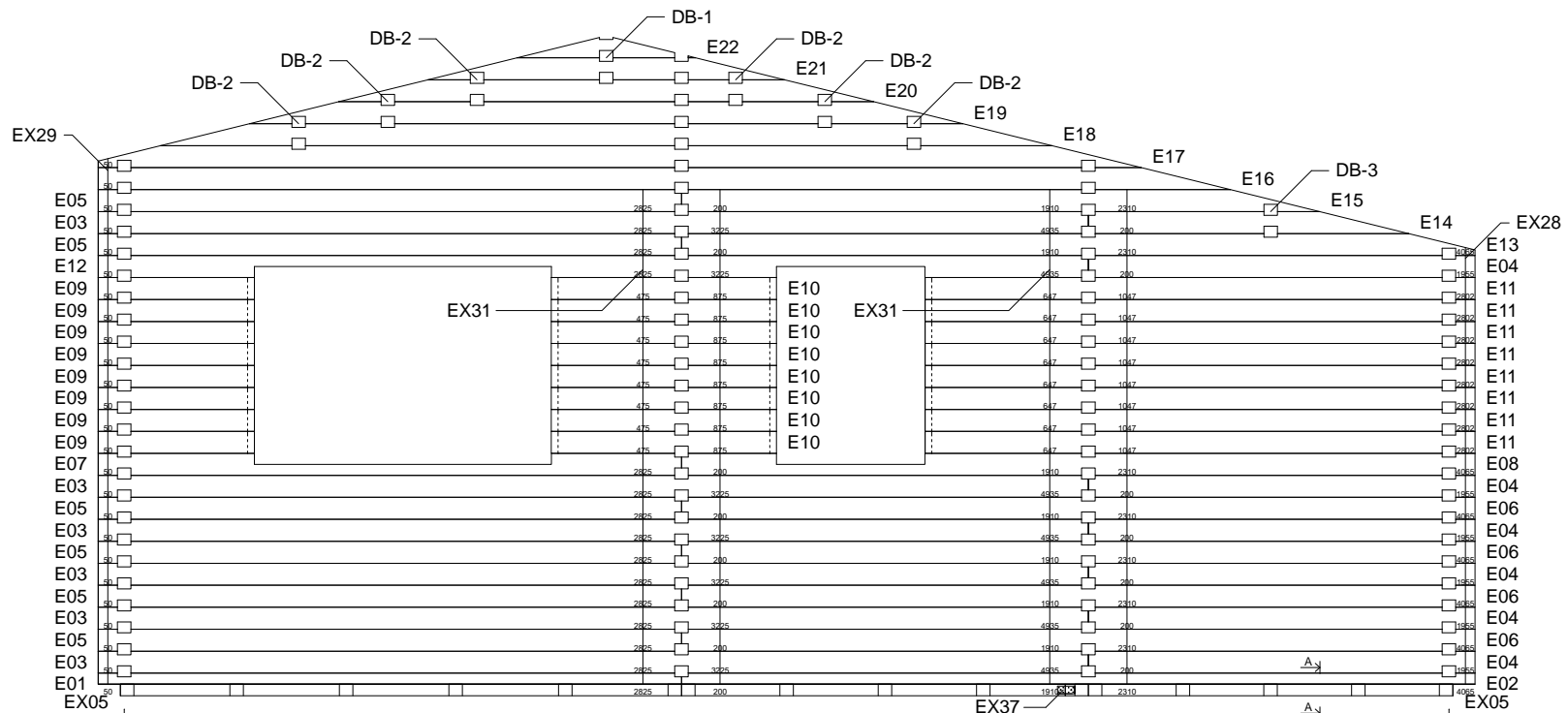

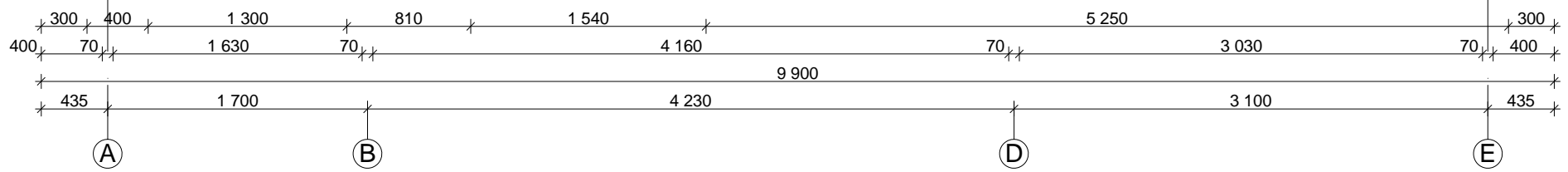
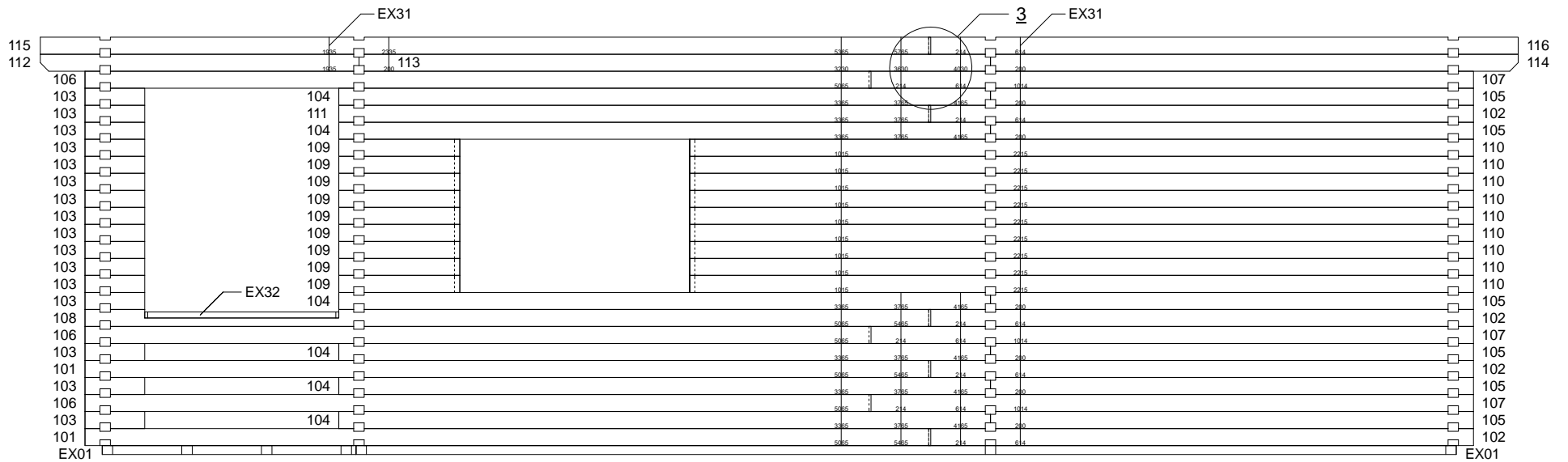

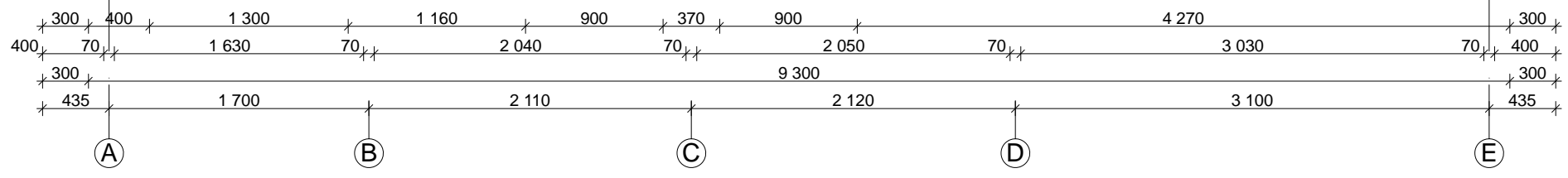
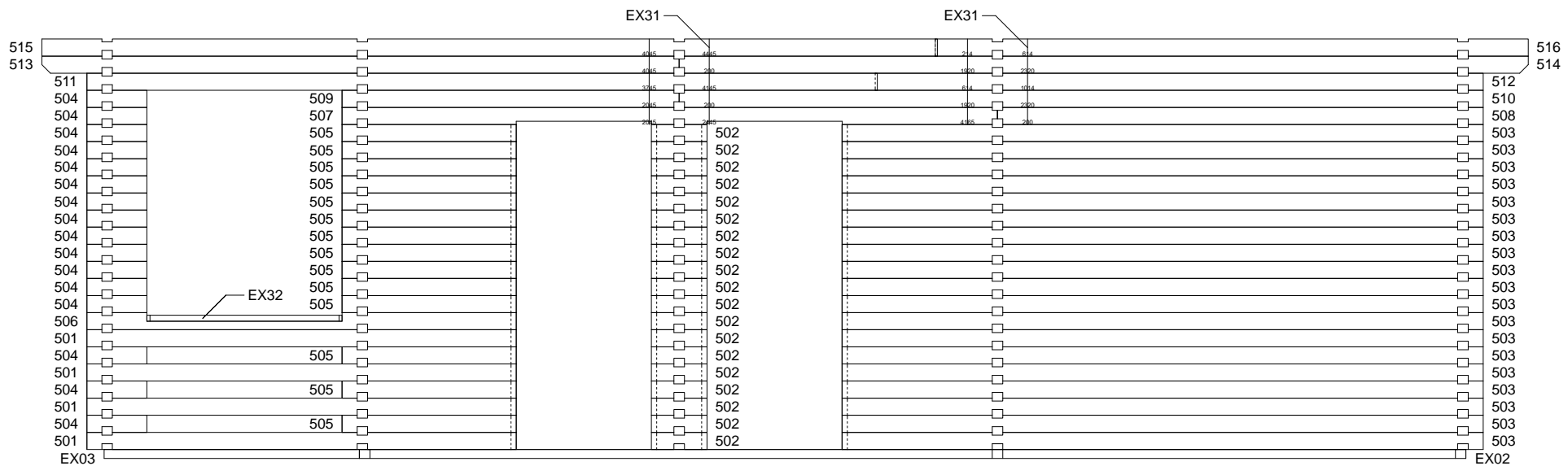

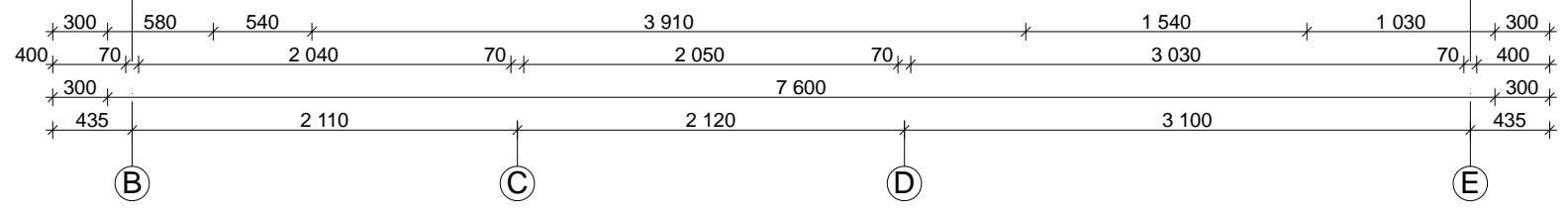
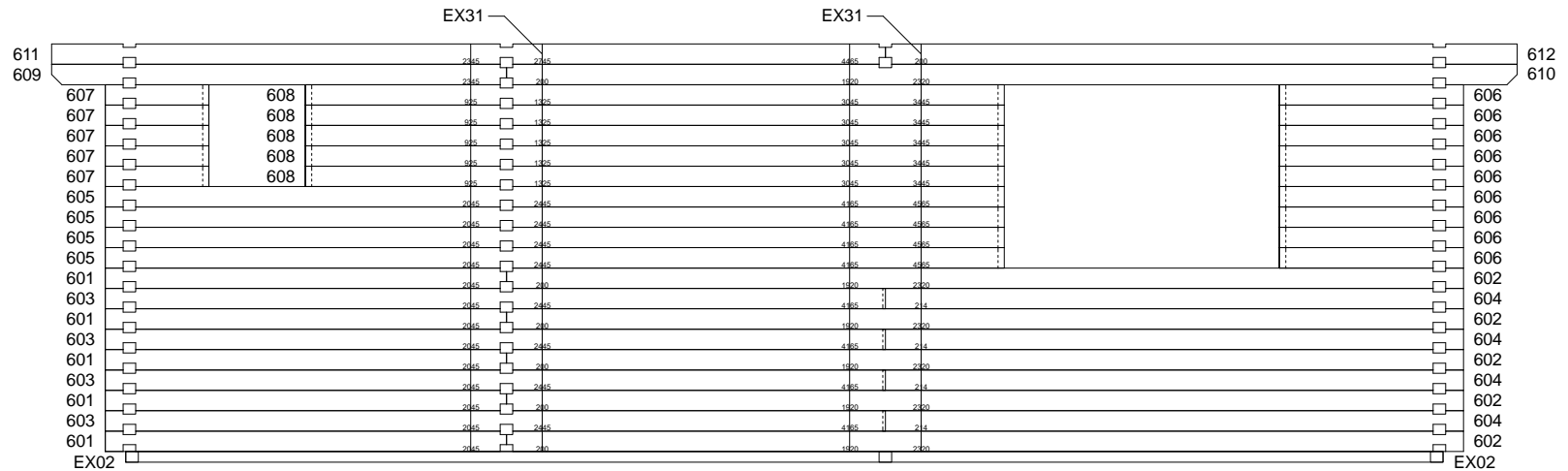
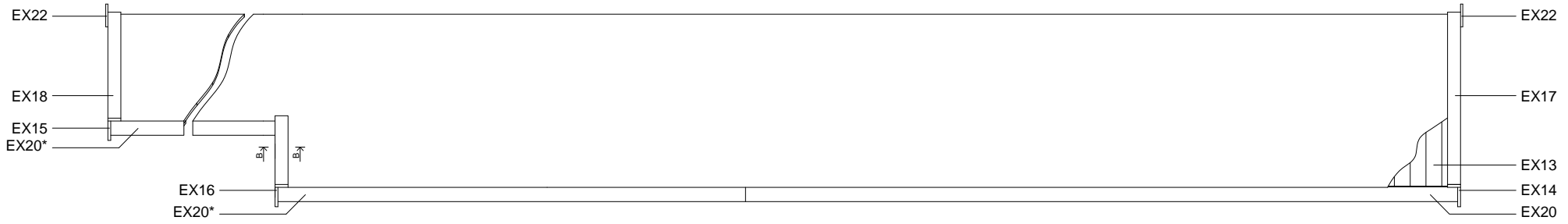

*

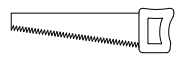

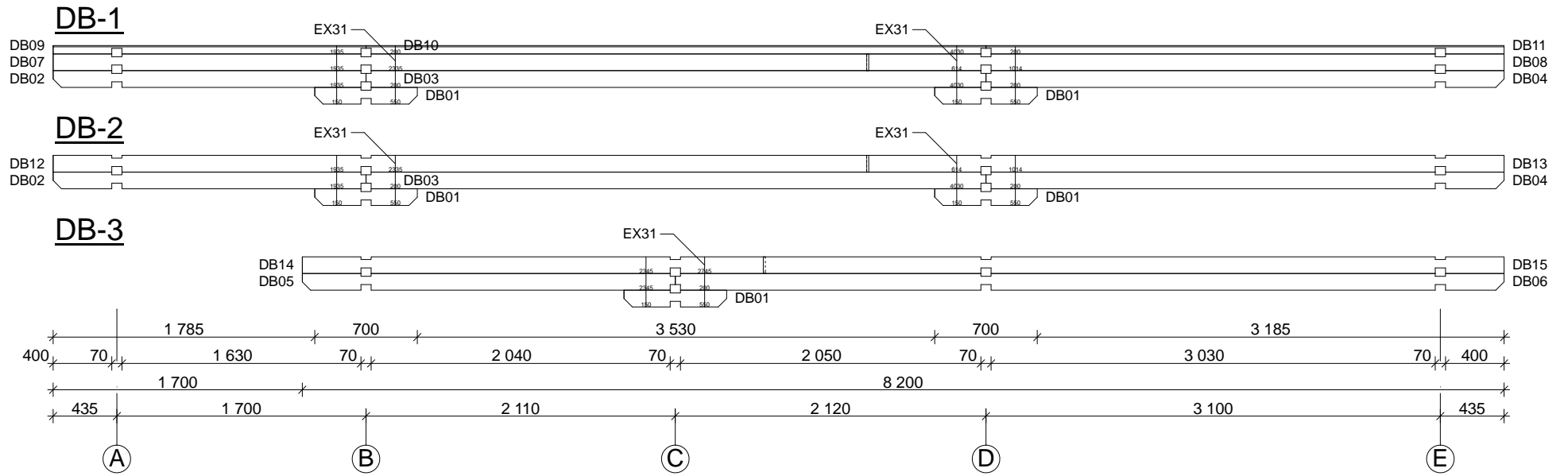

A-A

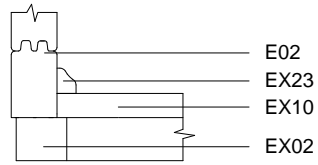

1

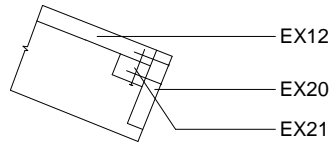

3

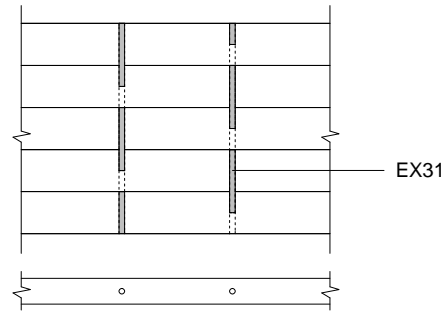

2

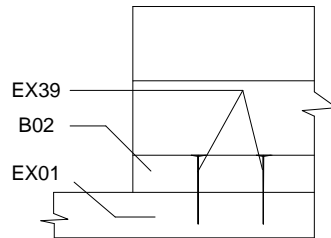

4

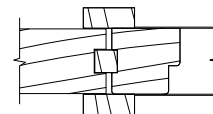

B-B

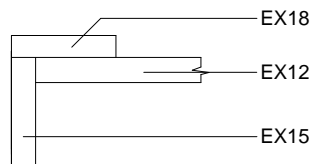

100 100

