

6/02/2019

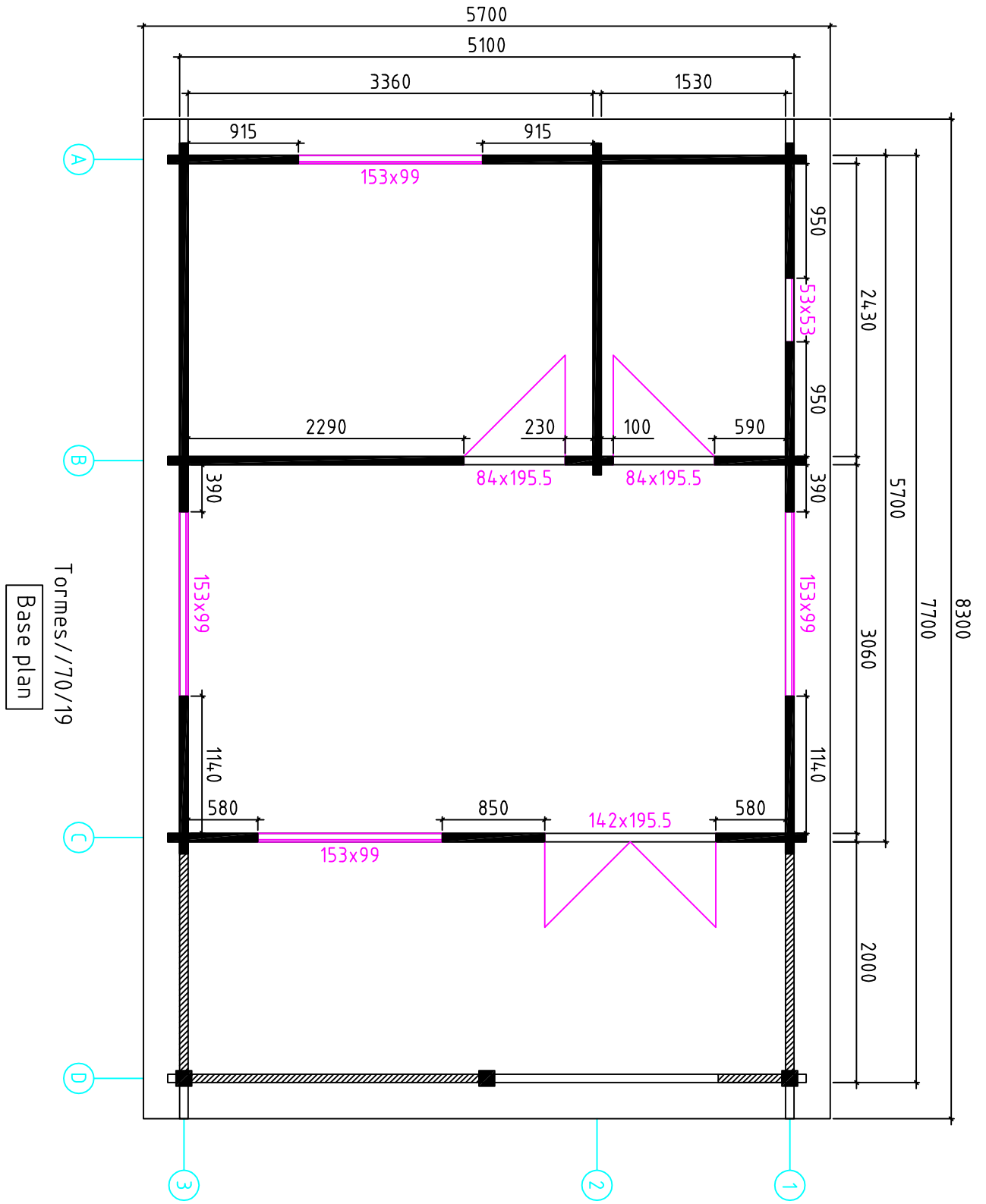

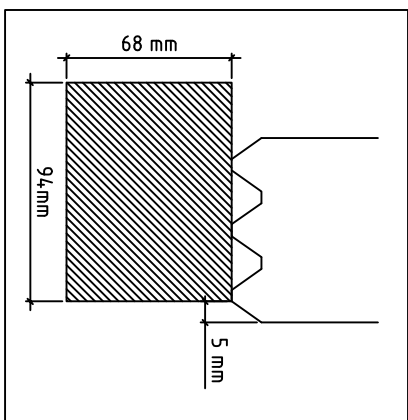

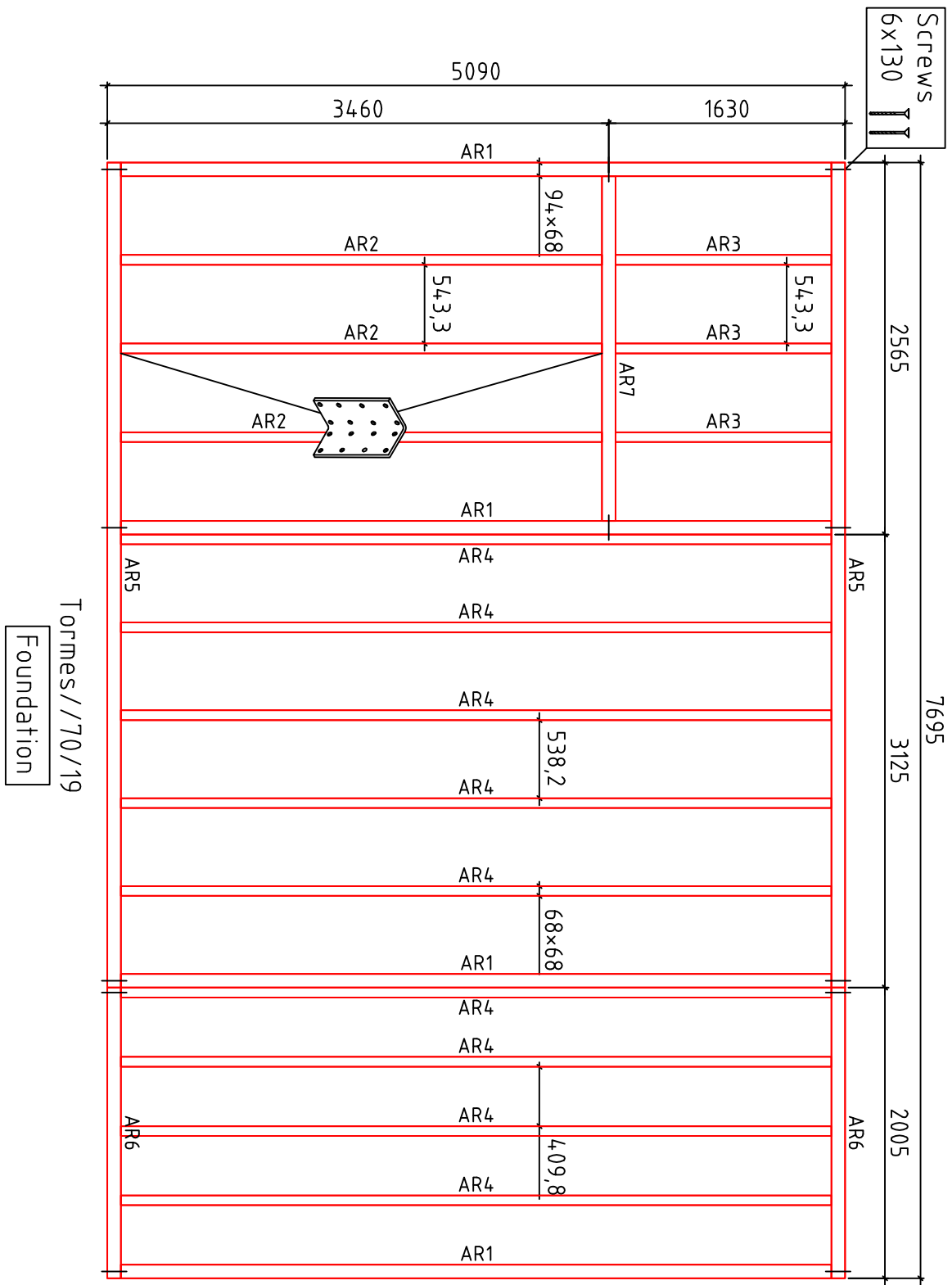
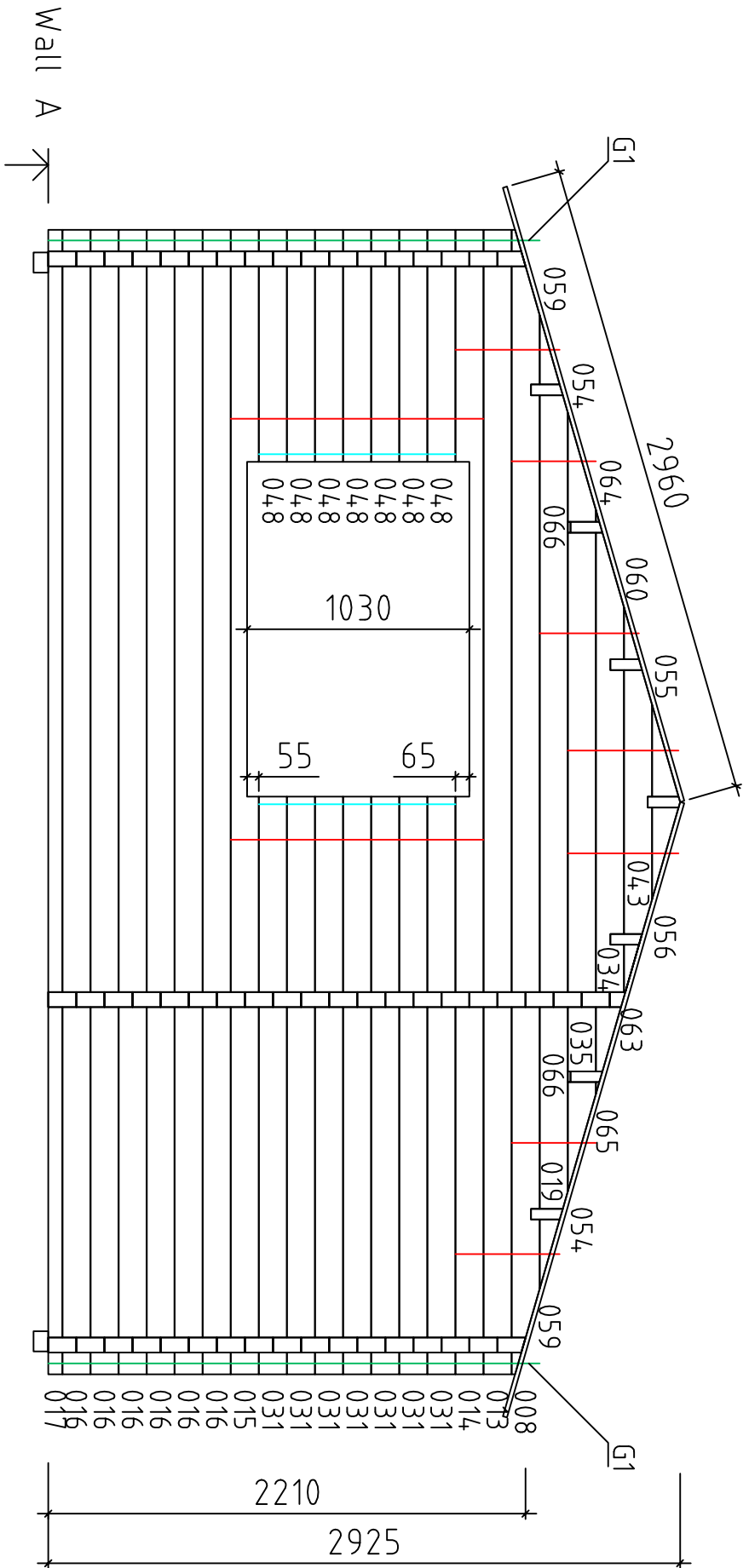

Tornes // 70 // 19

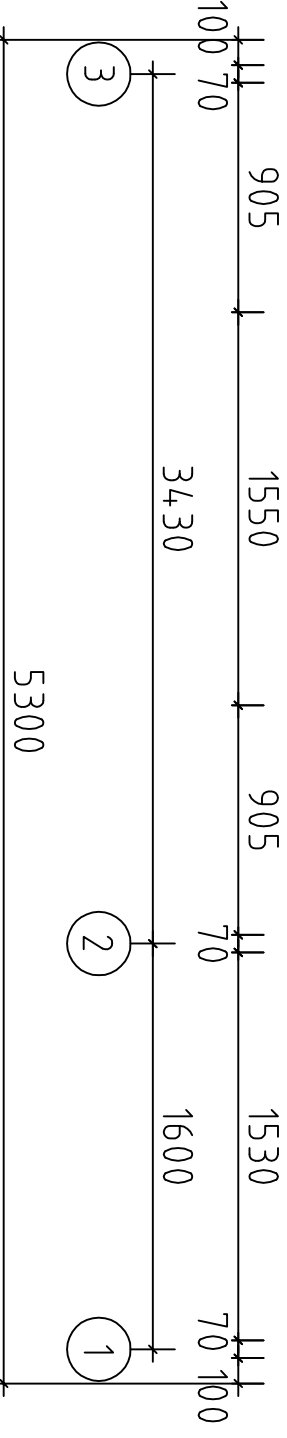

5300

3430

2210

2925

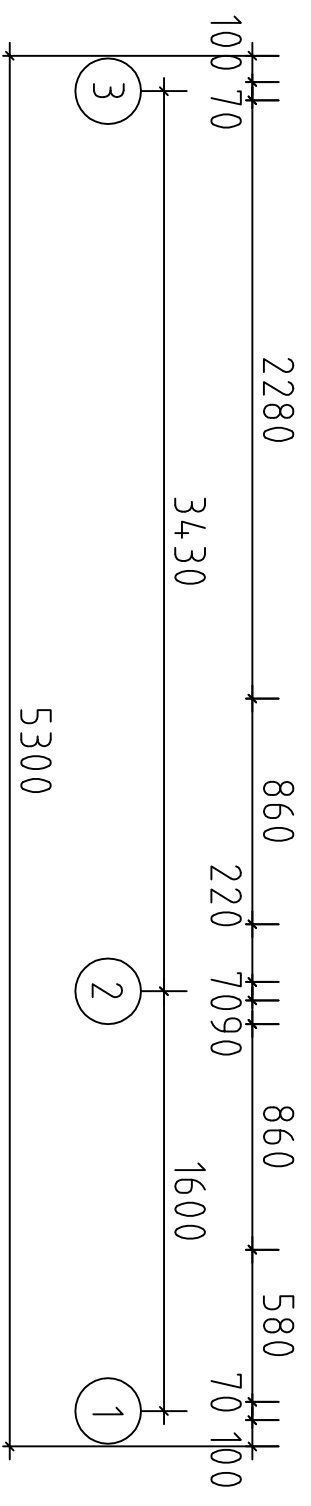
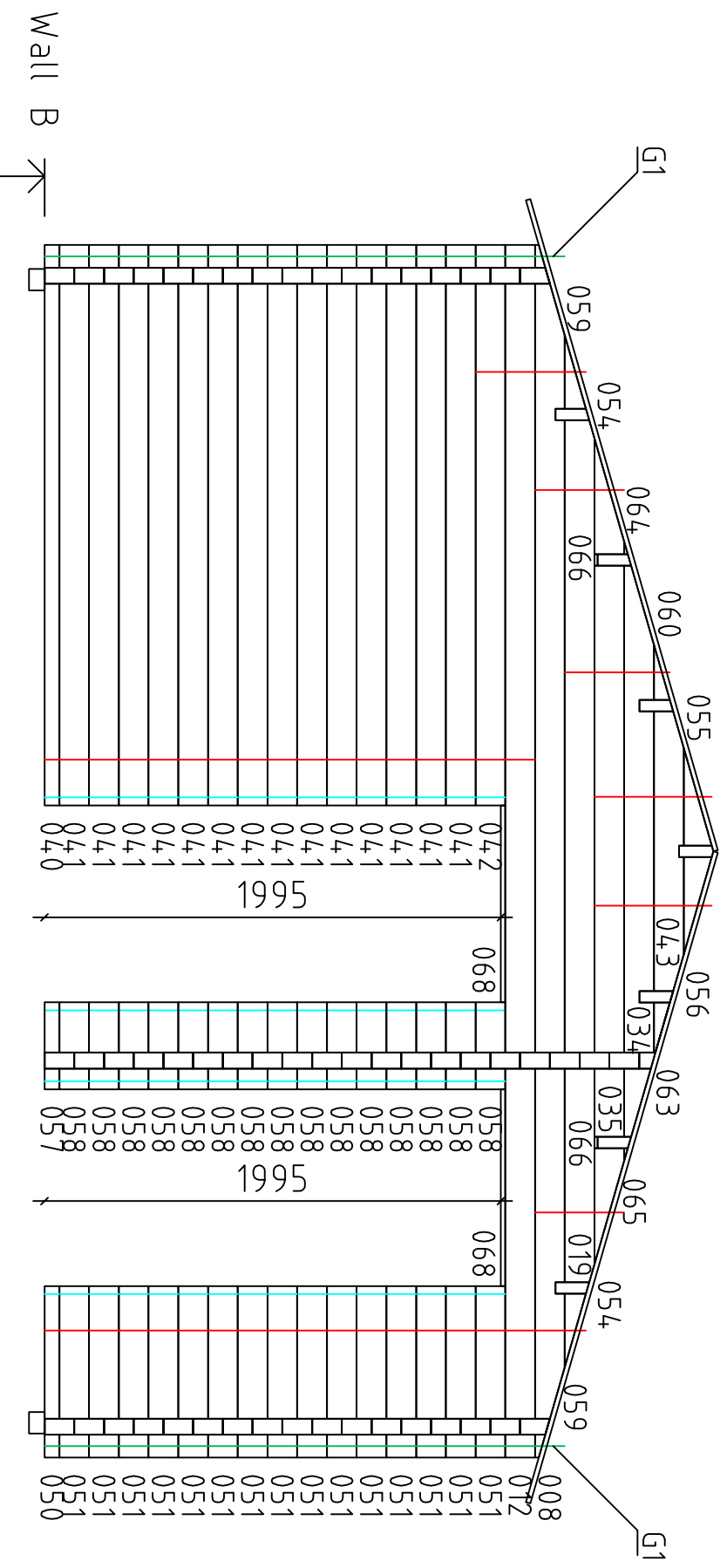

Tormes // 70 / 19

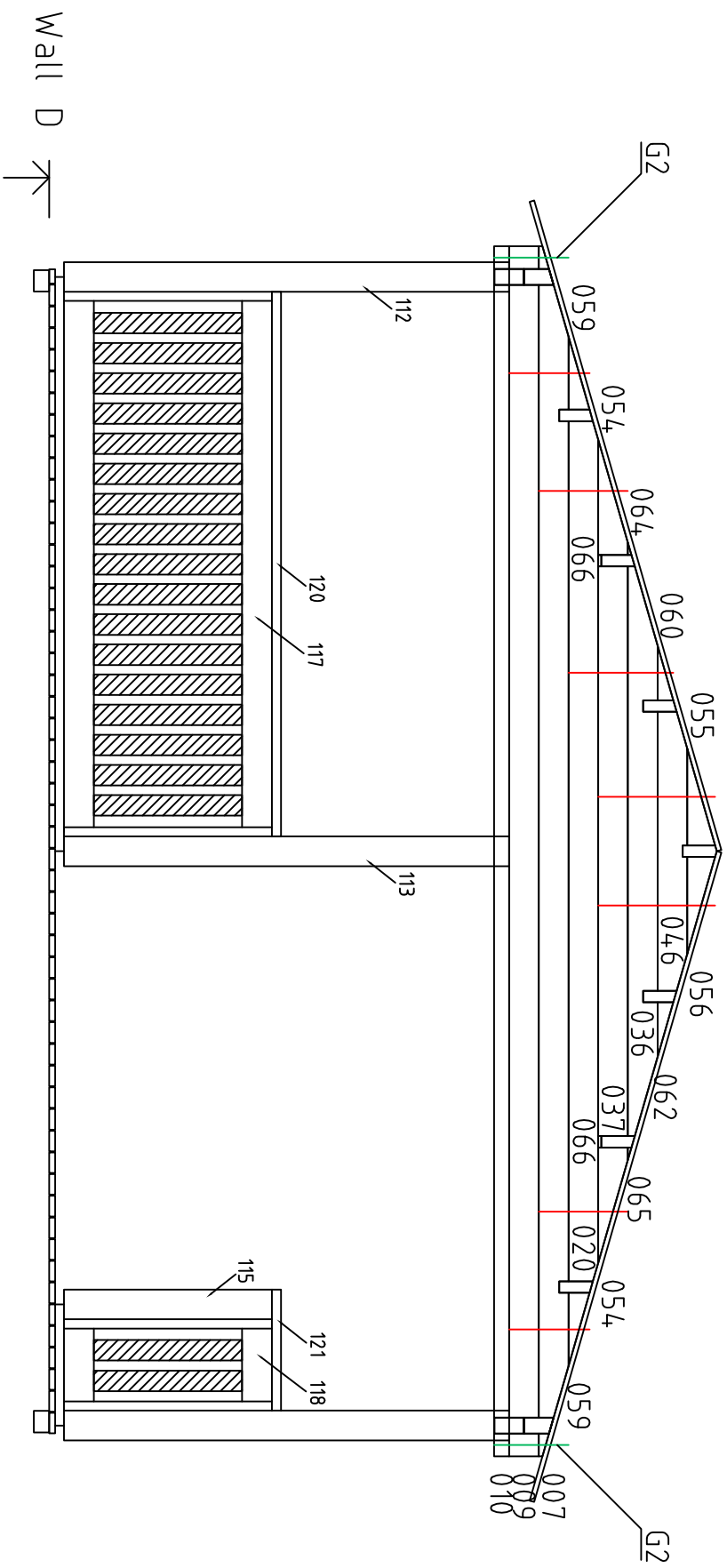

3

Tornes//70/19

1

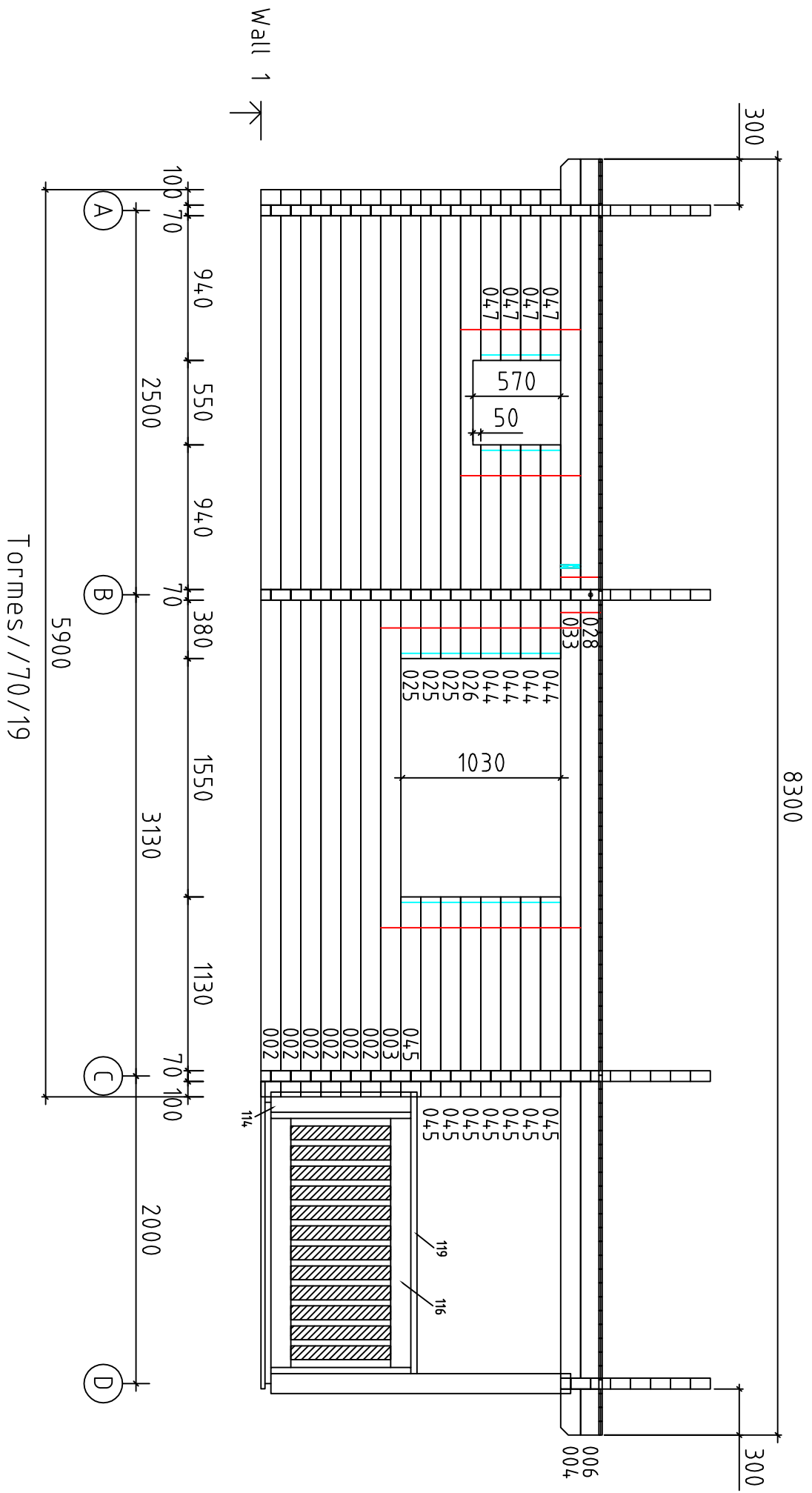

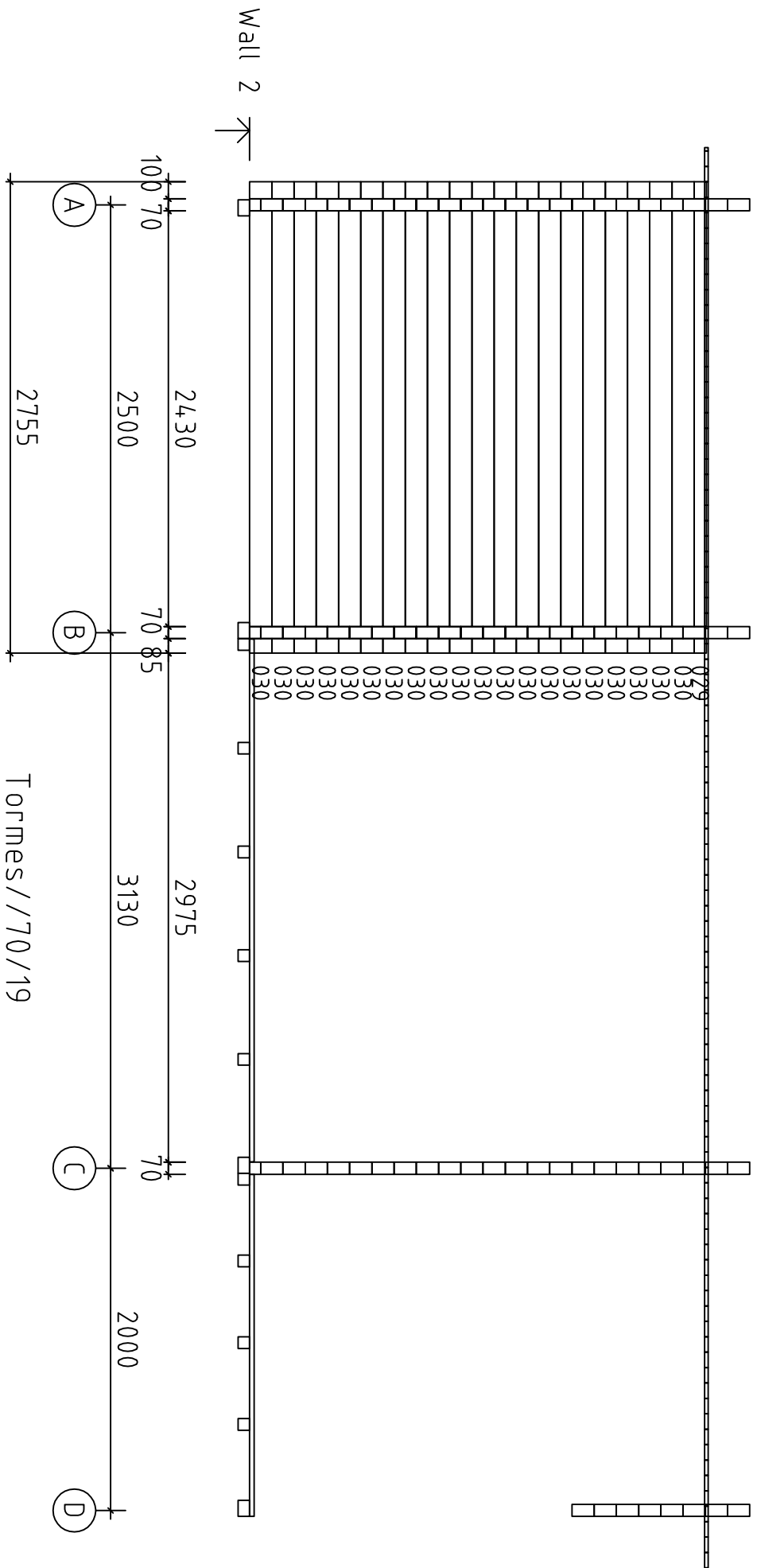



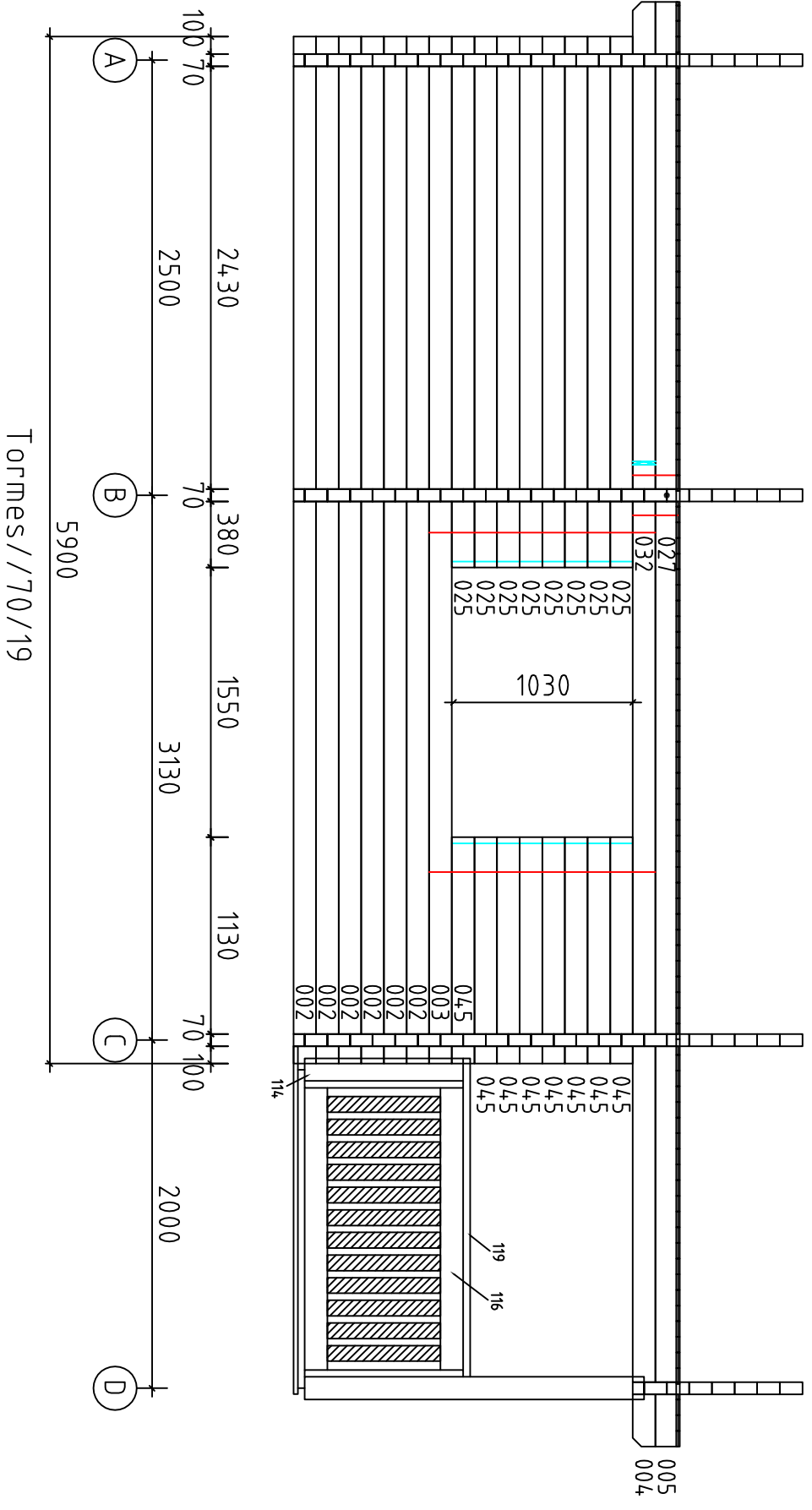



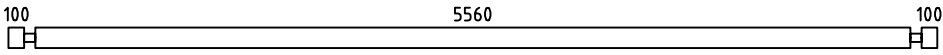
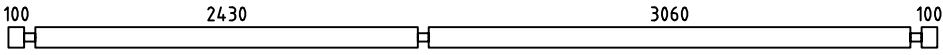
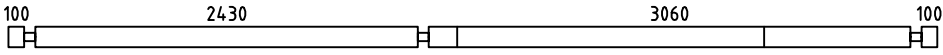
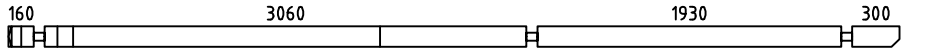
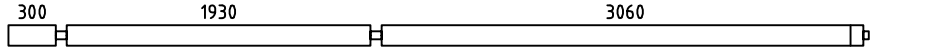
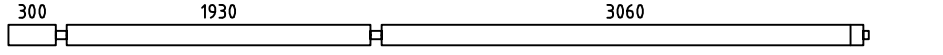
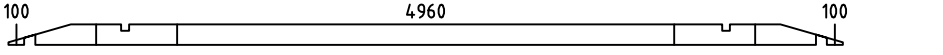
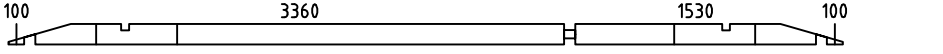
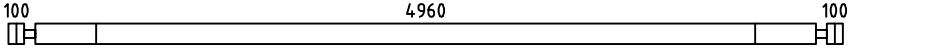
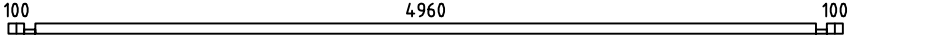
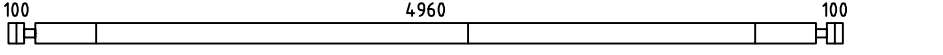
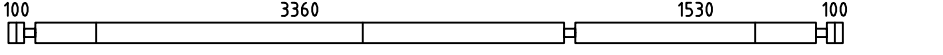
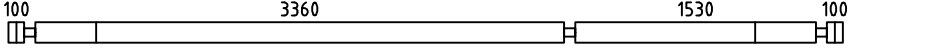
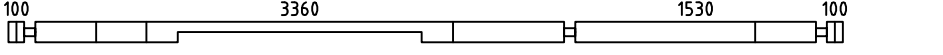
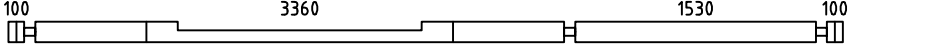
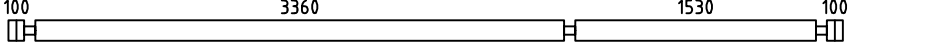
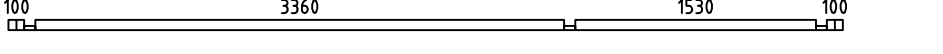
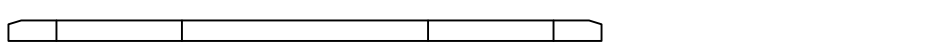
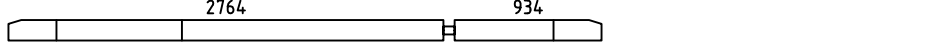
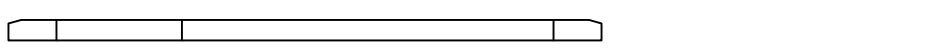
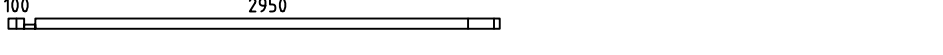
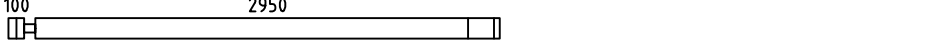
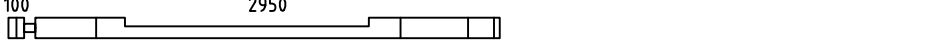
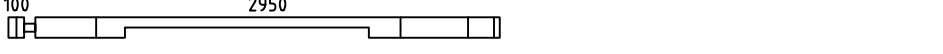
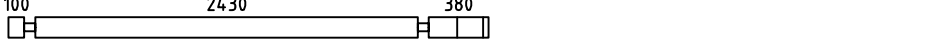

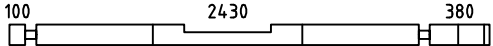
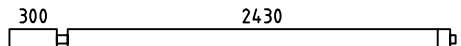
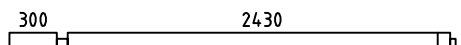
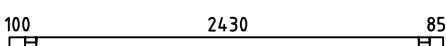
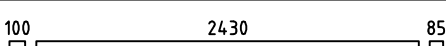
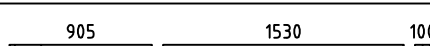
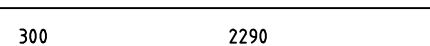
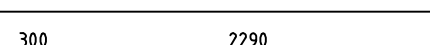
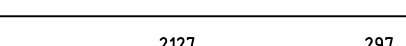
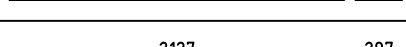
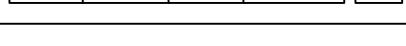
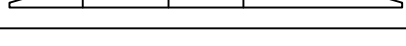
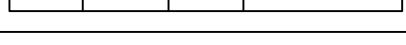
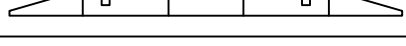
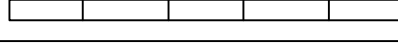
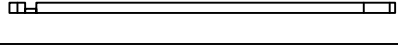
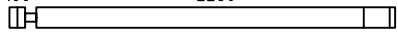
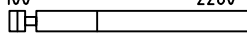
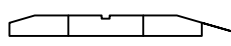
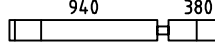
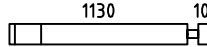

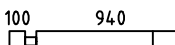
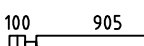
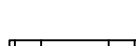

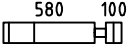
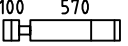
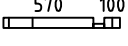

Wall 3 ↗











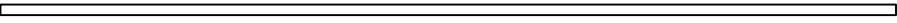
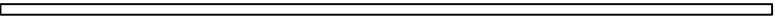
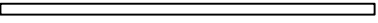
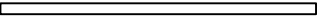
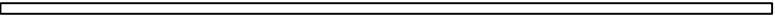
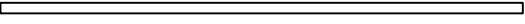
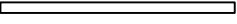
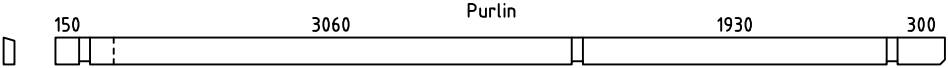
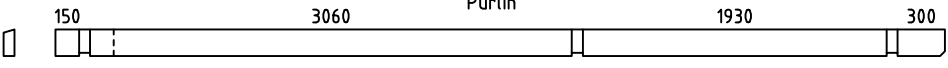
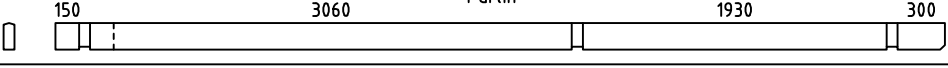
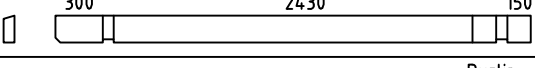
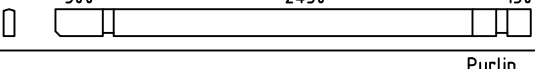
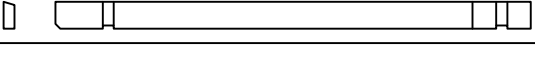

Tormes//70/19

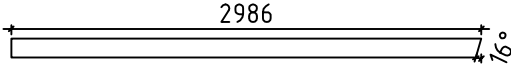
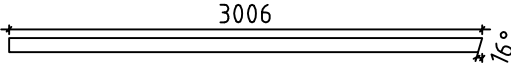
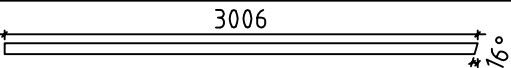

Pos	Tormes//70/19	ST	F (mm)	L (mm)
Reserv		2	70x130	5900
002		12	70x130	5900
003		2	70x130	5900
004		2	70x130	5660
005		1	70x130	5465
006		1	70x130	5465
007		2	70x130	5300
008		2	70x130	5300
009		1	70x130	5300
010		1	70x66	5300
011		1	70x130	5300
012		1	70x130	5300
013		1	70x130	5300
014		1	70x130	5300
015		1	70x130	5300
016		6	70x130	5300
017		1	70x65	5300
018		1	70x130	3767
019		2	70x130	3767
020		1	70x130	3767
021		1	70x65	3120
022		6	70x130	3120
023		1	70x130	3120
024		1	70x130	3120
025		11	70x130	3050

Pos	Tormes//70/19	ST	F (mm)	L (mm)
026		1	70x130	3050
027		1	70x130	2835
028		1	70x130	2835
029		1	70x71	2755
030		20	70x130	2755
031		7	70x130	2675
032		1	70x130	2660
033		1	70x130	2660
034		2	70x130	2495
035		2	70x130	2495
036		1	70x130	2495
037		1	70x130	2495
038		1	70x130	2495
039		1	70x130	2495
040		1	70x65	2450
041		14	70x130	2450
042		1	70x130	2450
043		2	70x130	1491
044		4	70x130	1390
045		16	70x130	1300
046		2	70x130	1222
047		4	70x130	1110
048		7	70x130	1075
049		7	70x130	830
050		1	70x65	750

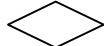
Pos	Tormes//70/19	ST	F (mm)	L (mm)
051		15	70x130	750
052		22	70x130	740
053		1	70x65	740
054		8	70x130	506
055		4	70x123	426
056		4	70x123	426
057		1	70x65	380
058		15	70x130	380
059		8	70x92	321
060		4	70x69	241
061		1	70x69	241
062		1	70x69	241
063		2	70x69	219
064	-	4	70x16	55
065	-	4	70x16	55
066	-	8	70x13	50
067		1	70x20	1440
068		2	70x20	860

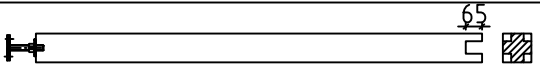
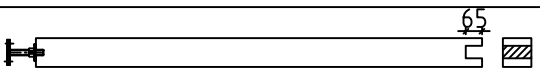
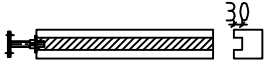
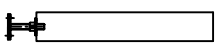
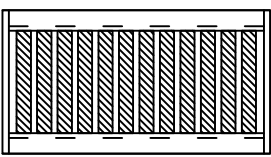
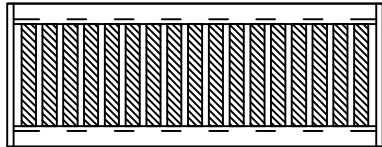
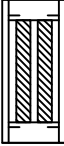
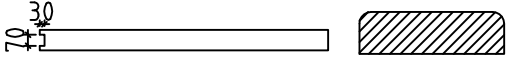
Pos	Tormes//70/19			ST	F (mm)	L (mm)	
AR5	Foundation beam 			Impr.	2	94x68	5690
AR1	Foundation beam 			Impr.	4	94x68	4902
AR7	Foundation beam 			Impr.	1	94x68	2377
AR6	Foundation beam 			Impr.	2	94x68	2005
AR4	Foundation beam 			Impr.	9	68x68	4902
AR2	Foundation beam 			Impr.	3	68x68	3319
AR3	Foundation beam 			Impr.	3	68x68	1489
PR2	 Purlin				3	70x170	5650
PR6	 Purlin				3	70x170	5650
PR4	 Purlin				1	70x170	5650
PR5	 Purlin				3	70x170	3020
PR3	 Purlin				1	70x170	3020
PR1	 Purlin				3	70x170	3020

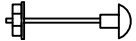
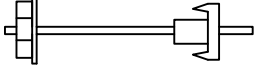
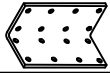
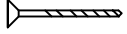
Pos	Tormes//70/19		ST	F (mm)	L (mm)
100	Floor boards		56	90x26	3056
			55	90x26	2426
101	Terrace boards	Impr. 	54	90x26	1998
102	Roof boards		186	90x20	2960
103	Baseboard			20x40	40lfm
104	Fascia board		4	20x120	2986
105	Fascia board		4	20x90	3006
106	Fascia board		4	20x70	3006
107	Gable edge board		4	20x70	3006
108	Eave edging		4	20x90	4150
109	Eave edging slat		4	50x50	4150
110	Diamond		2		
111	Dowel		264		
112	Post		2	130x130	1930
113	Post		1	130x130	1930
114	Post		2	130x130	910
115	Post		1	130x130	910
116	Barrier		2		
117	Barrier		1		
118	Barrier		1		
119	Handrail		2	40x130	1830
120			1	40x130	2385

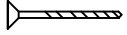
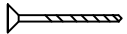
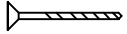
Pos	Tormes//70/19			ST	F (mm)	L (mm)
121	Handrail			1	40x130	530
122	Hitblock			2	70x130	ca400
210	Bolts for purlins			28	M12	80
G1	Threaded rod 12			6		2195
G2				2		245
KMPL.	Angle bracket			40	60x60x60	
	Screws for angle brackets 4x40			400		
	Screws for foundation beams 6x130			30		
	Screws for boards 4x50			1650		
	Screws for terrace boards 4x55			270		
	Screws for barrier and handrail 5x80			60		

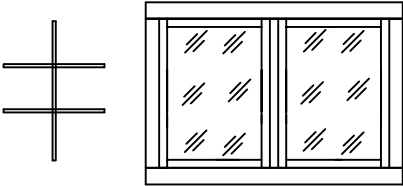
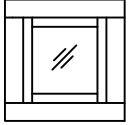
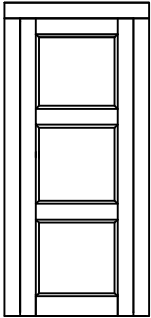
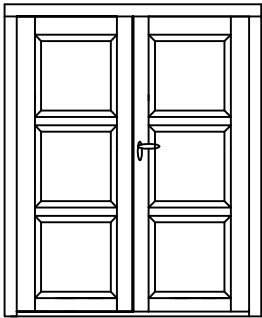
Pos	Tormes//70/19	ST	F (mm)	L (mm)
F1	<p style="text-align: center;">Window 1530x990</p> 	4		
F2	<p style="text-align: center;">Window 530x530</p> 	1R		
T1	<p style="text-align: center;">Door 840x1955</p> 		1L+1R	
T2	<p style="text-align: center;">Door 1420x1955</p> 	1R		
Kood	Materjal	File trükk (inglise).dwg	Leht 4/4	