

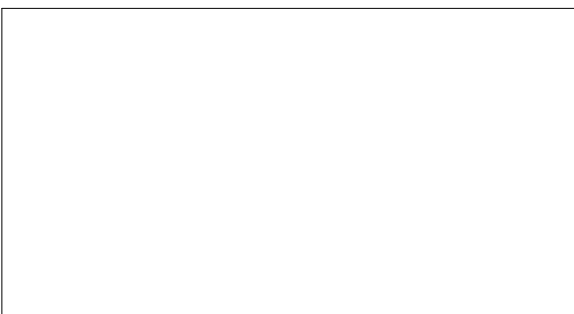

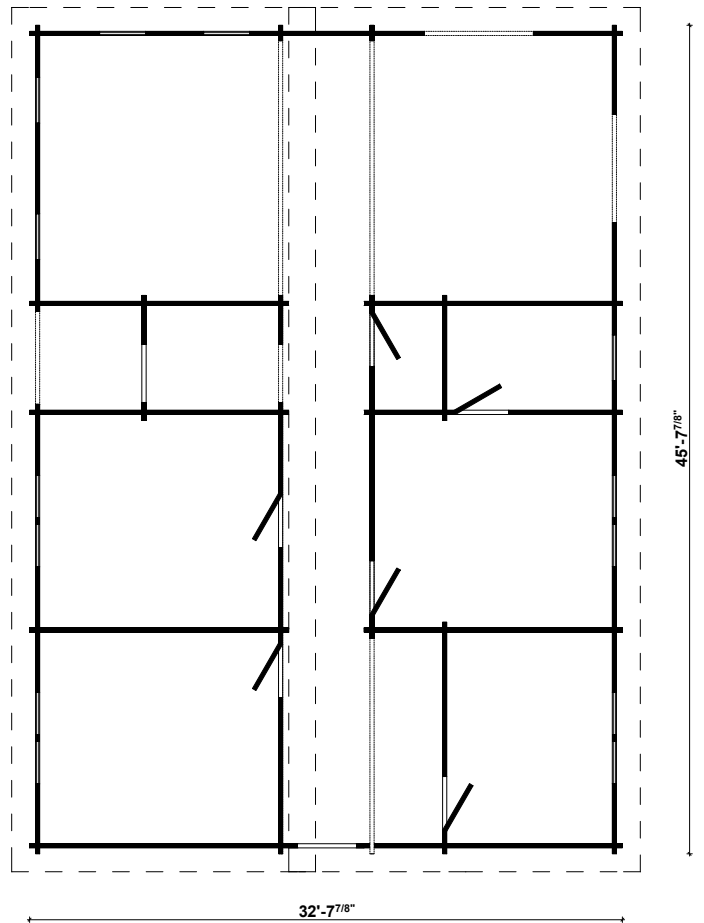

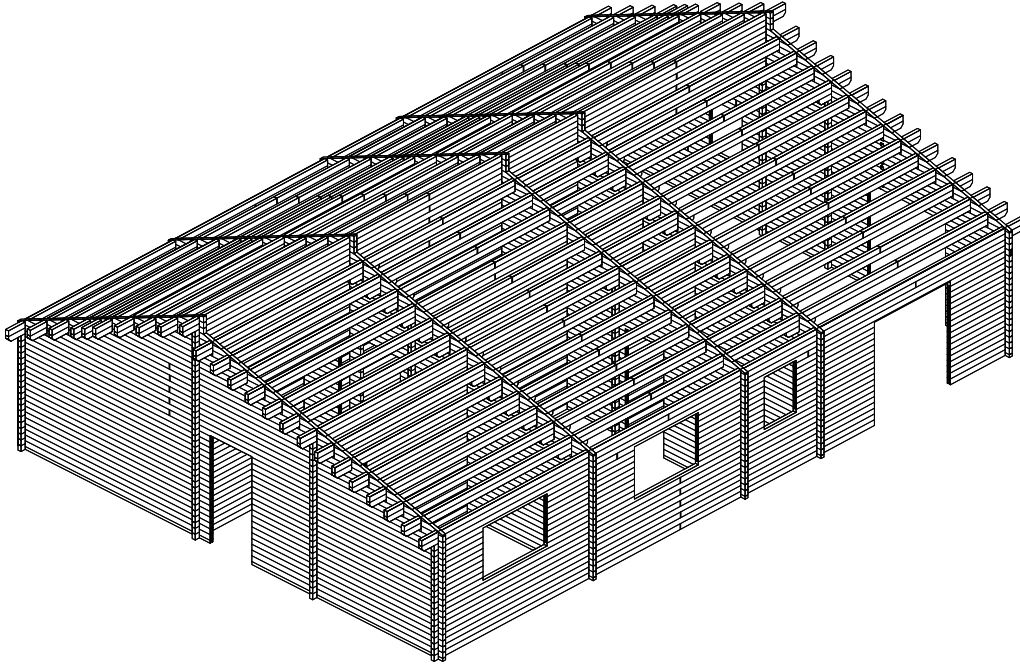





Seattle

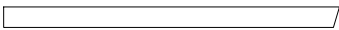

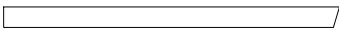
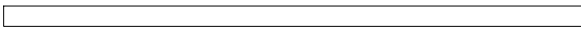
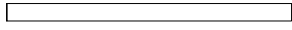
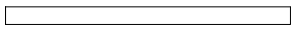
Note: All dimensions are approximate !
Achtung : Alle angegebenen Maße sind ca. - Maße !

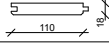
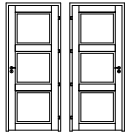
EZ Log 62170071 / 934 x 1392 cm - Specification

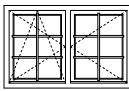
Nr.		 mm	 mm	 x
EX01	Roof board 	 18x110	3410/2830	132+2/132
EX02			5540	132
EX03	Floor board	28x110	--	--
EX04	Fascia board 	18x143	2830	2
EX05	Fascia board 		5580/3430	2/2
EX06	Eave edging 	18x90	5580	2
EX07			3130	4
EX08	Roof edge reinforcement 	18x115	3629	8
EX09		18x143	3629	4
EX10	Roof edge reinforcement	25x38	4838	9
EX11	Slat	20x20	2040	2
EX12	Slat		1930	2
EX13	Slat		1980	2
EX14	Slat		1868	2
EX15	Slat		28x55	400
EX15/1		3545		1
EX15/2		3580		1
EX15/3		1750		1
EX15/4		4460		1
EX16	Baseboard 		--	
EX17	Storm braces		--	--
EX18	Nut, washer			--
EX19	Screws 4,0 x 40; 4,0 x 50		400/3000	
EX20	Screws 6,0 x 160			2000
EX21	Wall decking (extra dry)		ca. 1278,0 m	
EX22	Door 890 x 2090 mm / 70 mm - R+L 			6(2+4)
EX23	Window 765 x 990 mm DG / 70 mm 			5
EX24	Double window 1530 x 990 mm DG / 70 mm 			4
EX25	Hitblock		300-400	

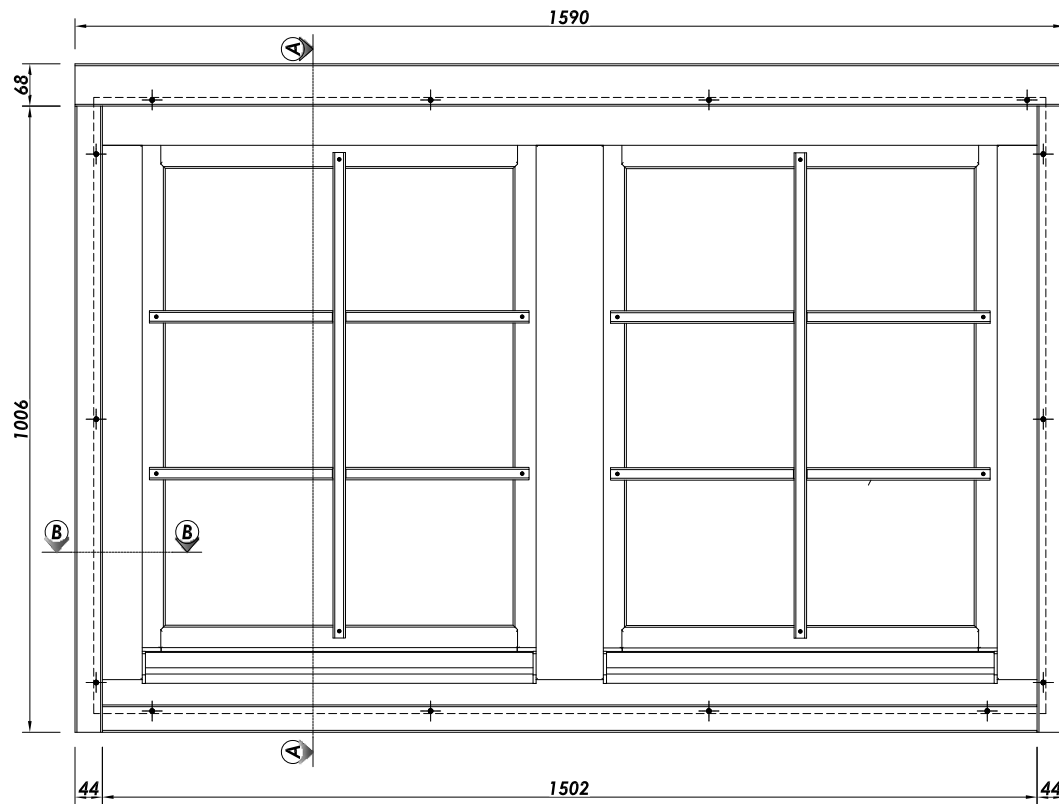

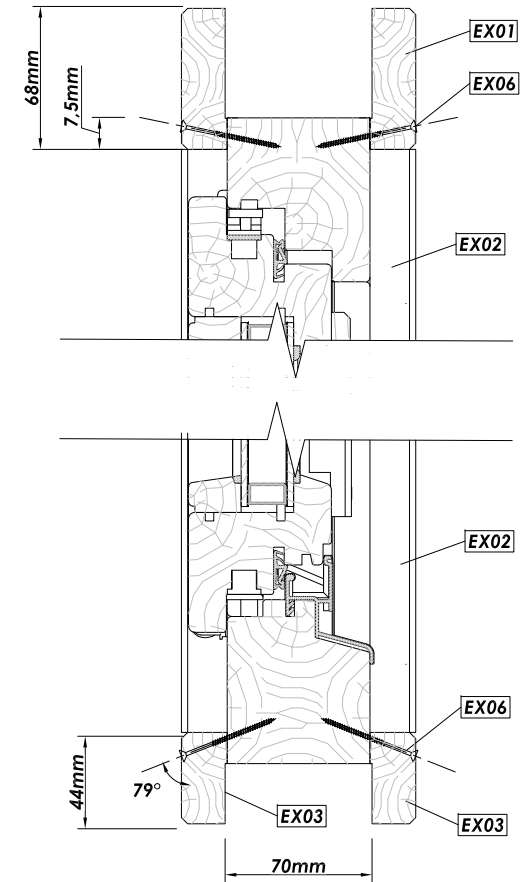

A - A

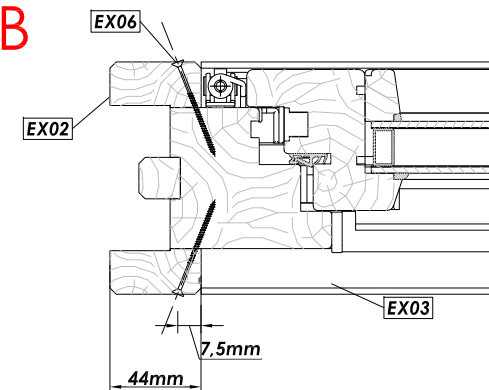

B - B

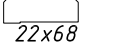
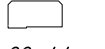

Premium Window 70mm / 1530 x 990

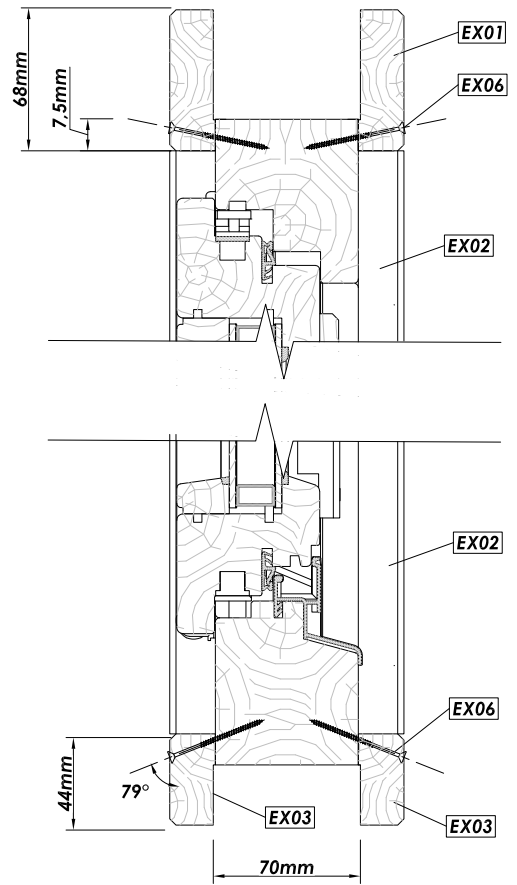
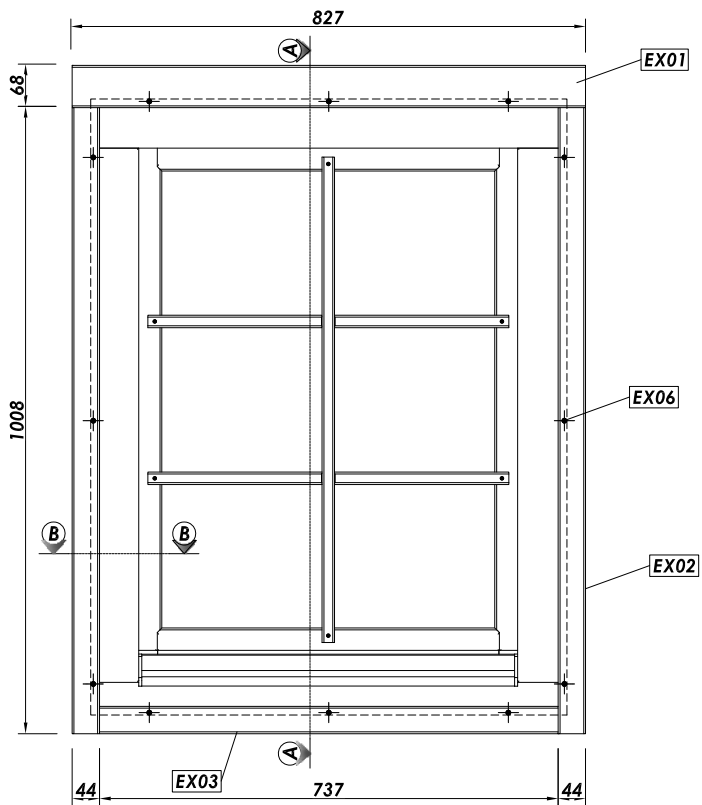

Nr.	Description	Profile mm	Length mm	Quantity
EX01	Exterior- and interior trim	 22x68	1590	2
EX02	Exterior- and interior trim	 22x44	1006	4
EX03			1502	2
EX04			--	--
EX05			--	--
EX06	Screws 3,5 x 50			

A - A

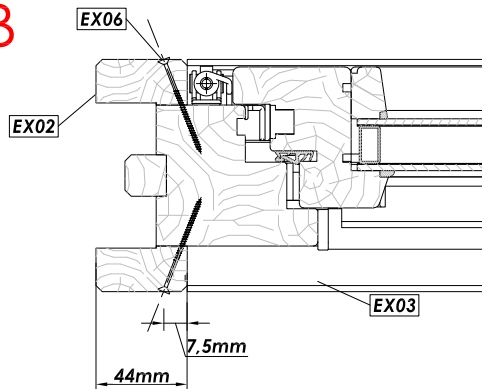

B - B

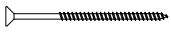

Premium Window 70mm / 765 x 990				
Nr.	Description	Profile mm	Length mm	Quantity
EX01	Exterior- and interior trim	 22x68	827	2
EX02	Exterior- and interior trim	 22x44	1008	4
EX03			737	2
EX04			--	--
EX05			--	--
EX06	Screws 3,5 x 50			

EZ LogV.3 62170071 / 934 x 1392 cm - B

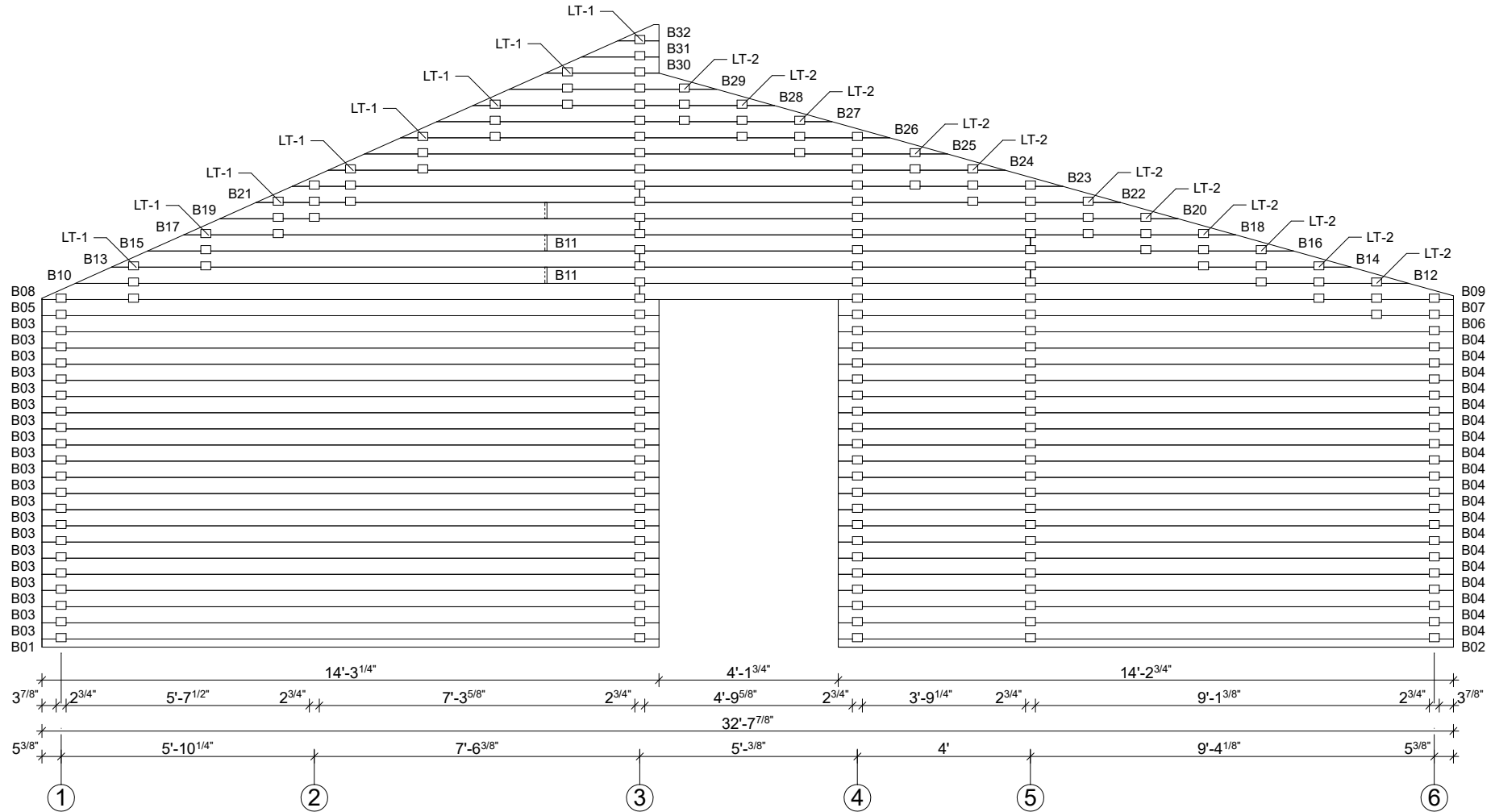

EZ LogV.3 62170071 / 934 x 1392 cm - D

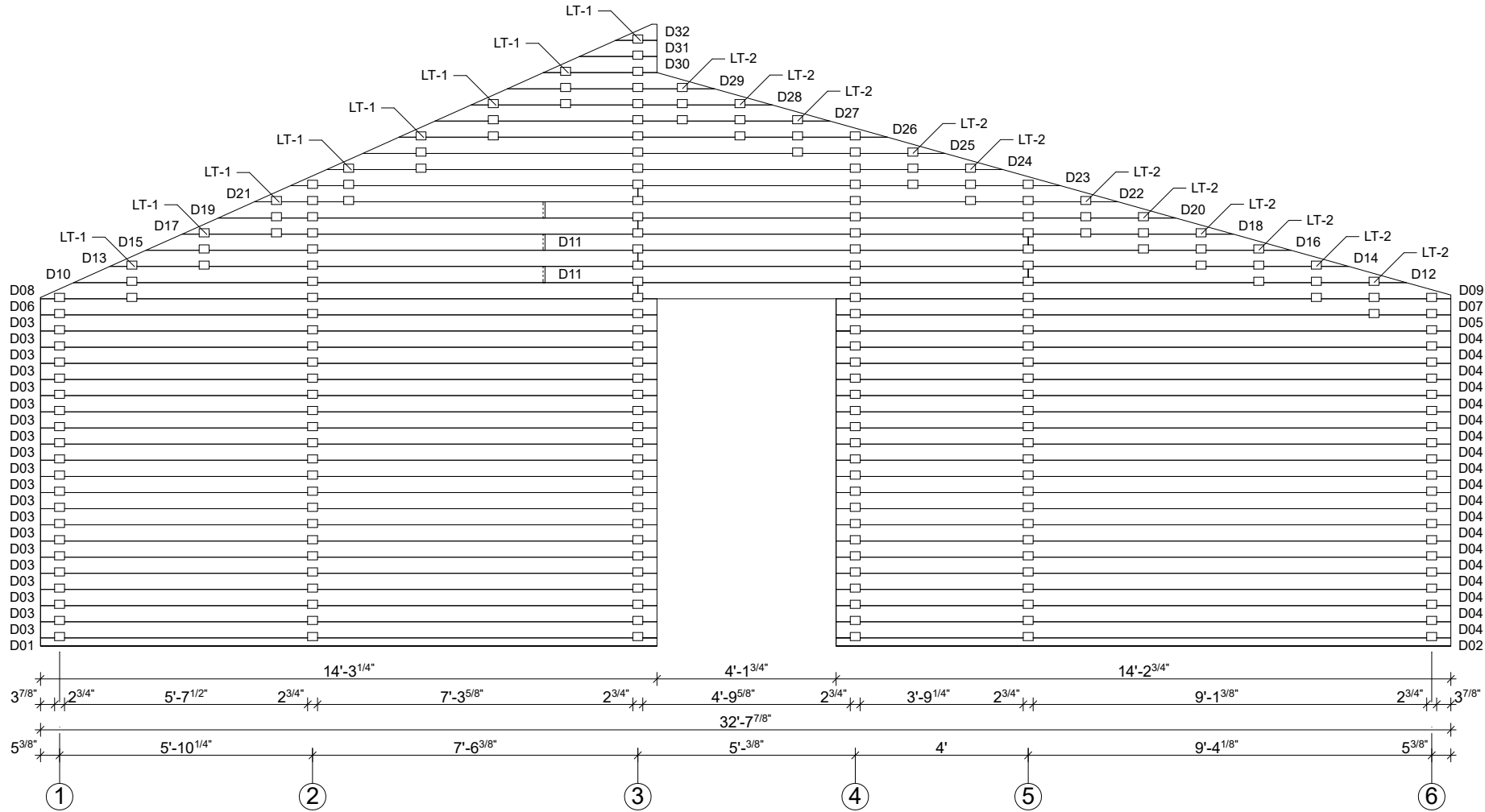

EZ LogV.3 62170071 / 934 x 1392 cm - E

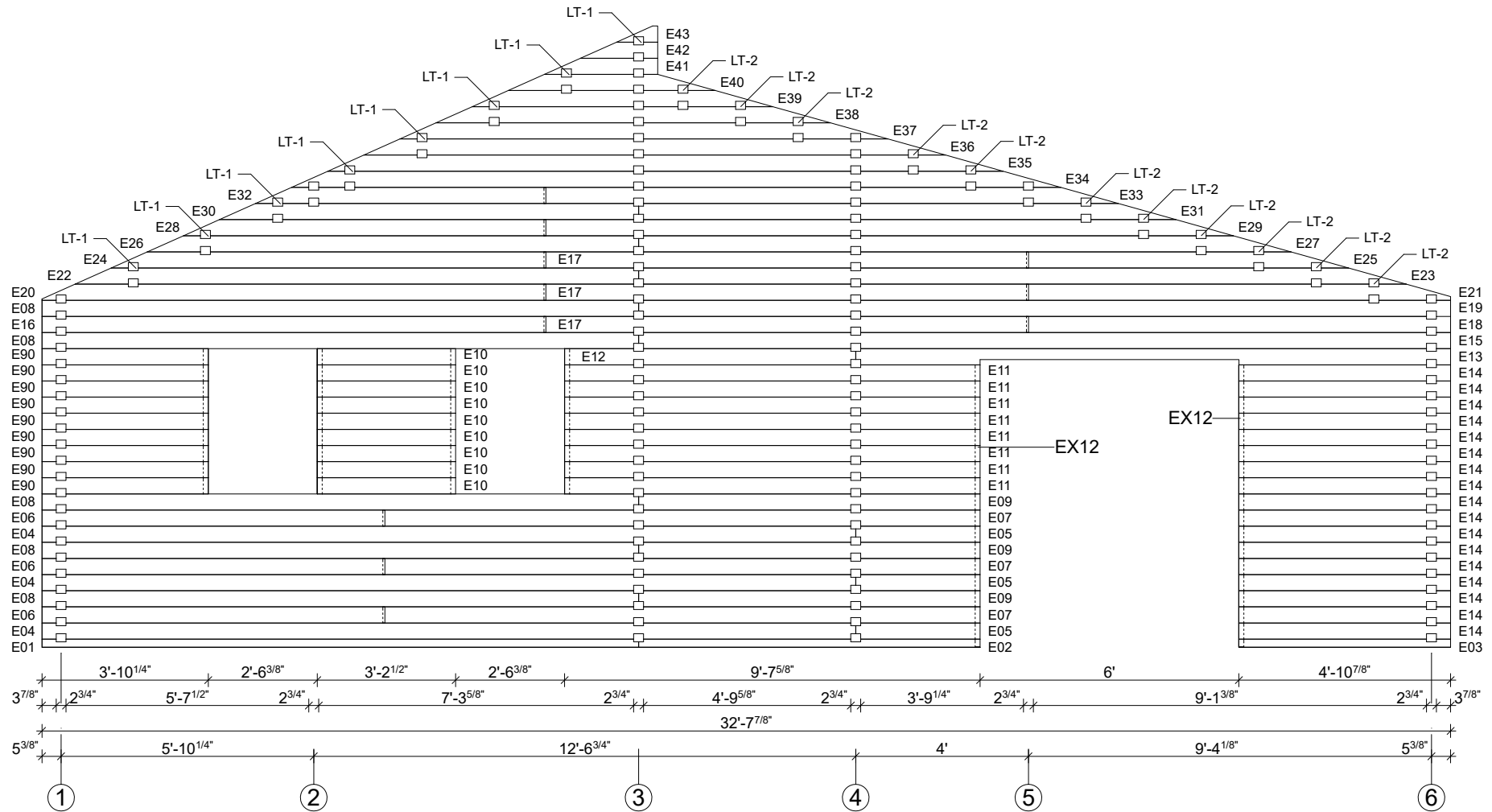

EZ LogV.3 62170071 / 934 x 1392 cm - 1 ; 2

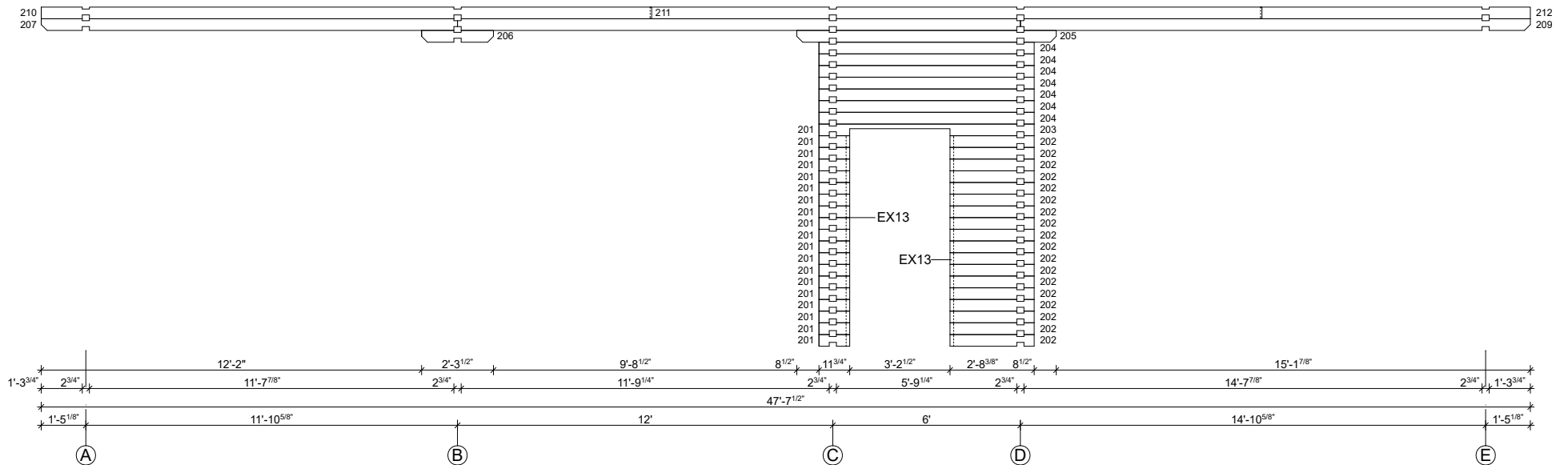
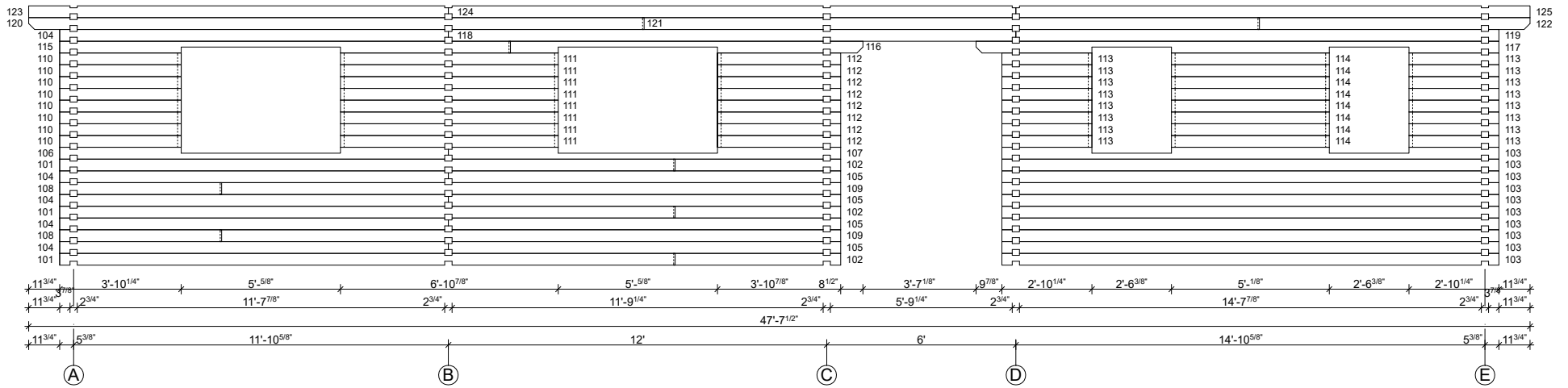

EZ LogV.3 62170071 / 934 x 1392 cm - 3 ; 4

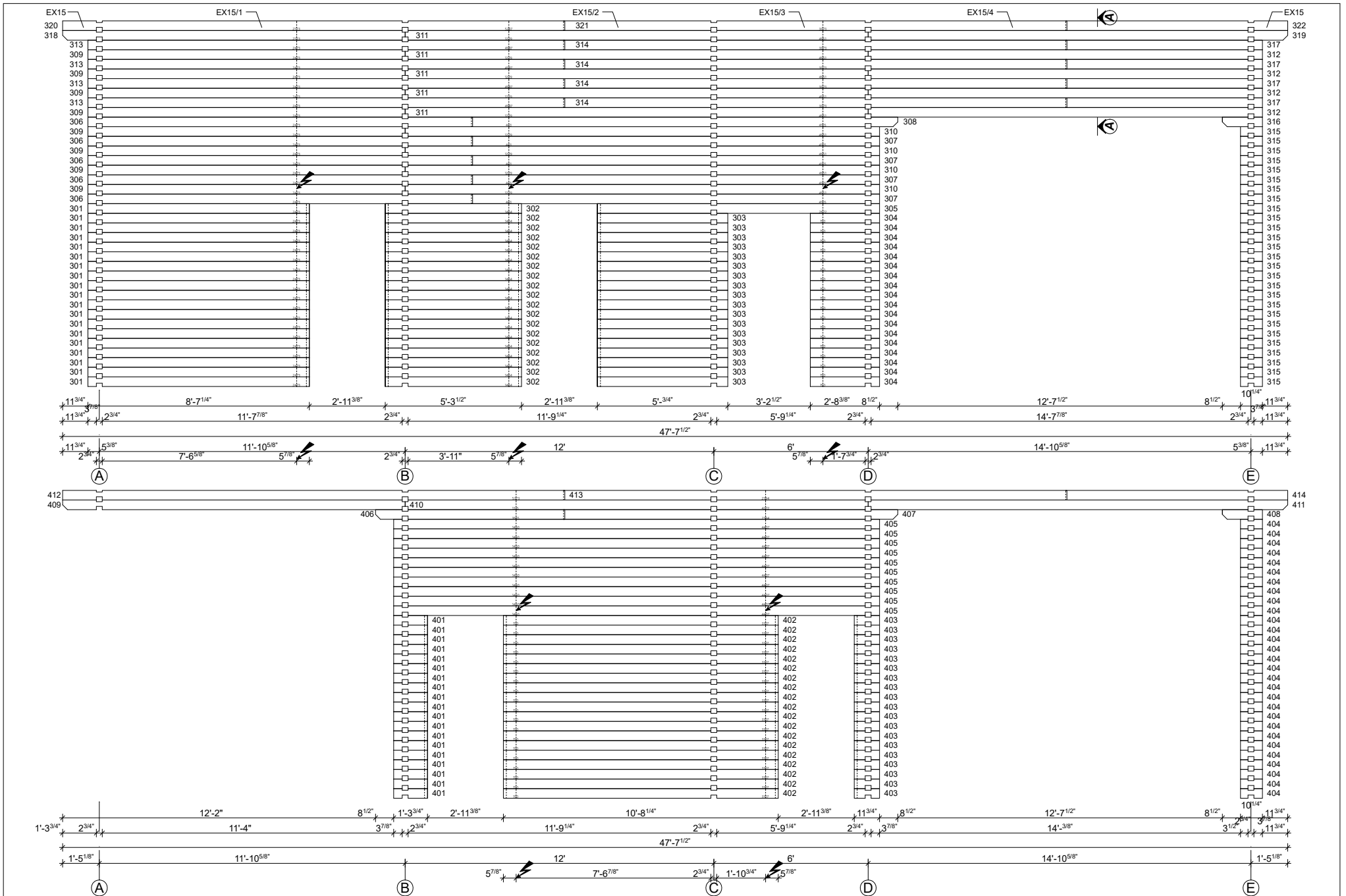

EZ LogV.3 62170071 / 934 x 1392 cm - 5 ; 6

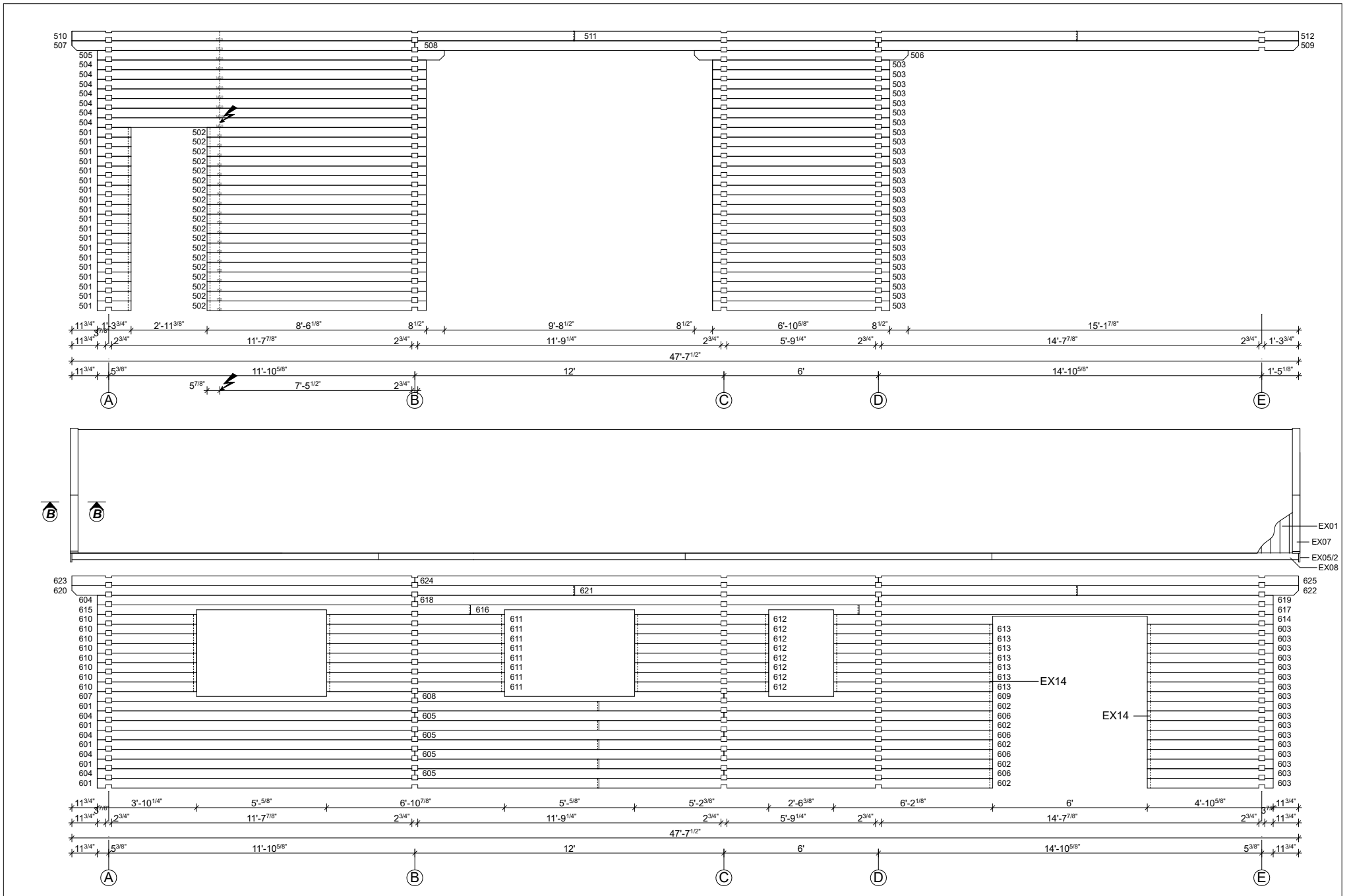

EZ LogV.3 62170071 / 934 x 1392 cm - B

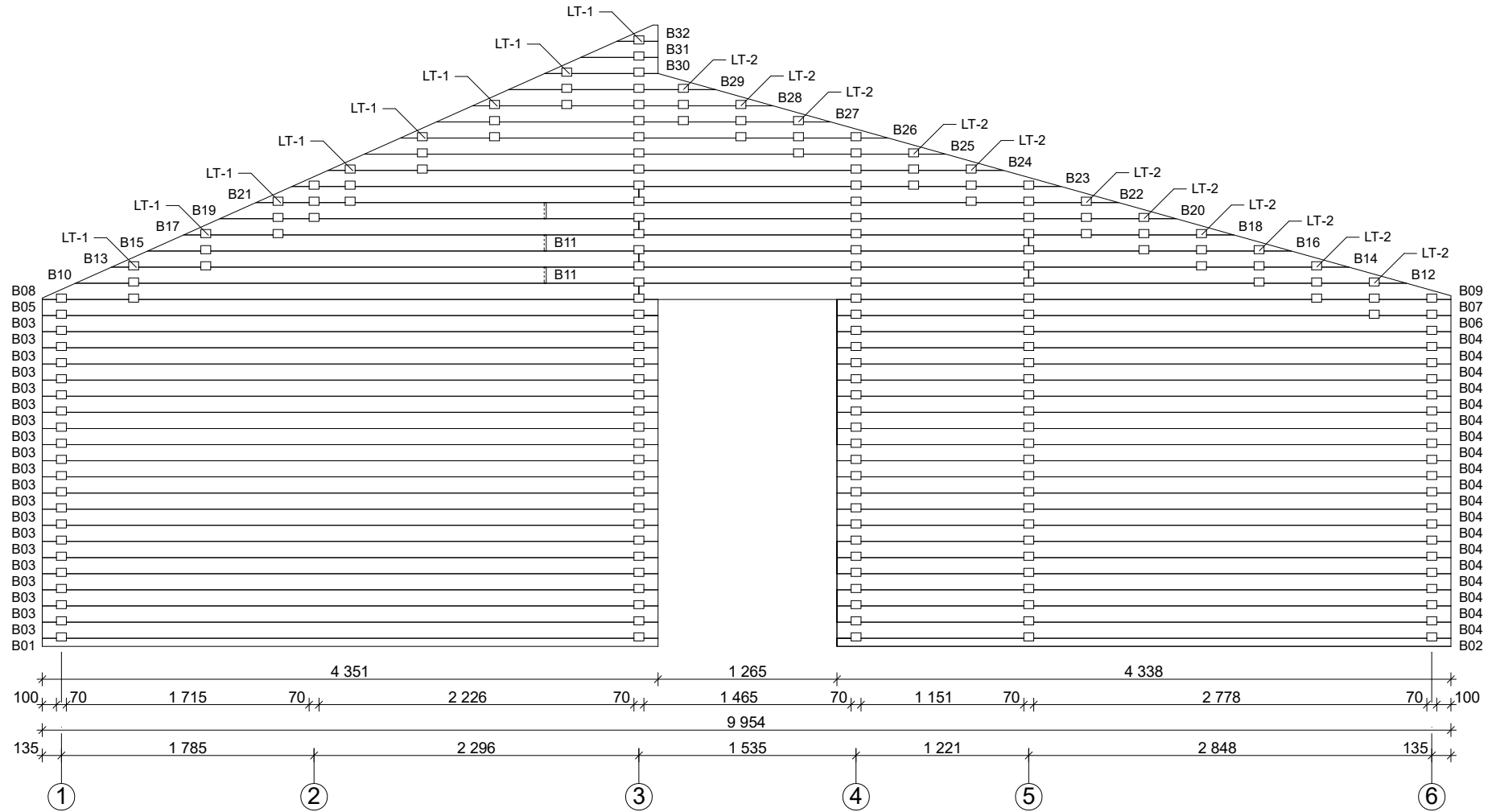

EZ LogV.3 62170071 / 934 x 1392 cm - C

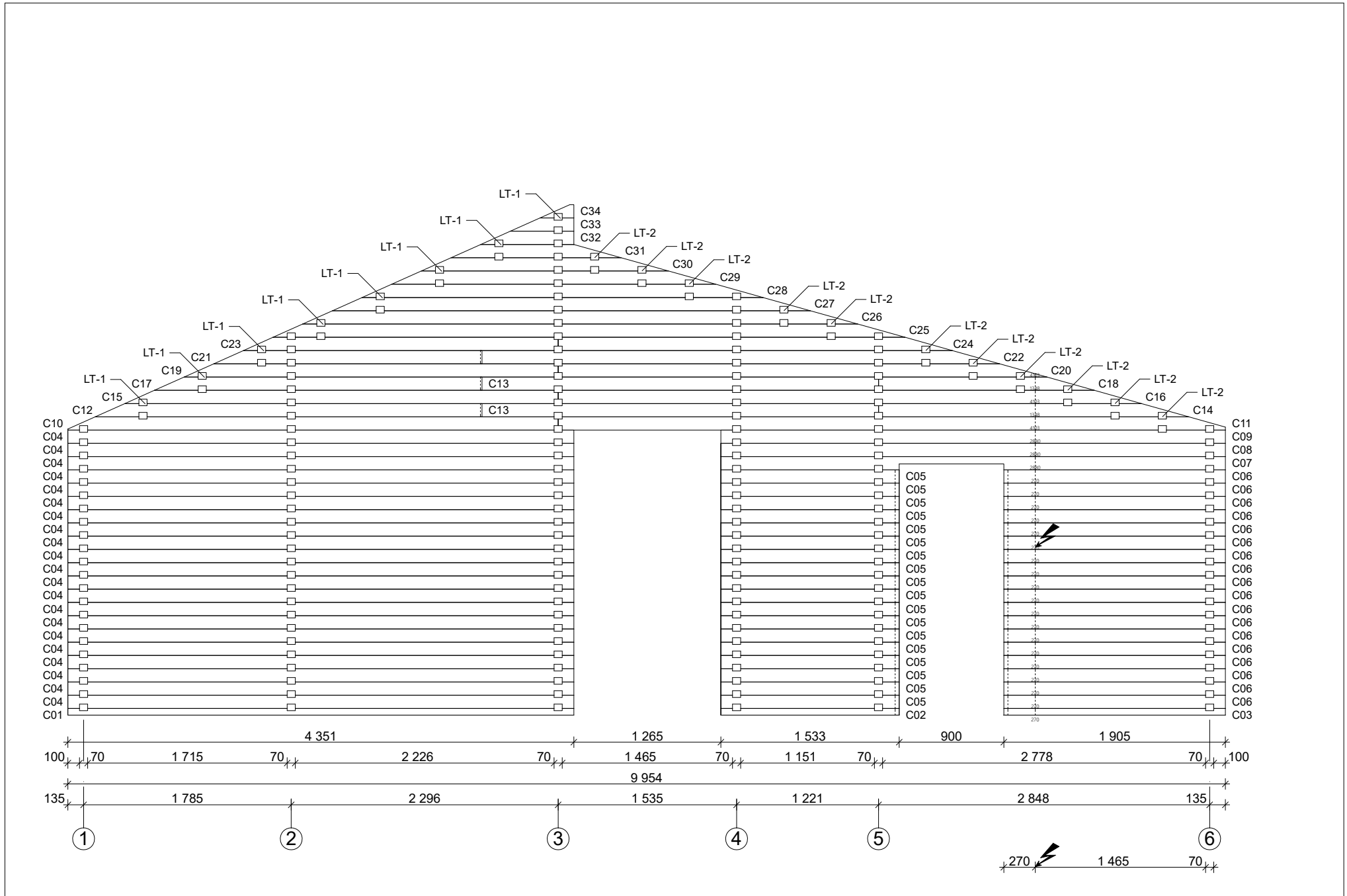

EZ LogV.3 62170071 / 934 x 1392 cm - D

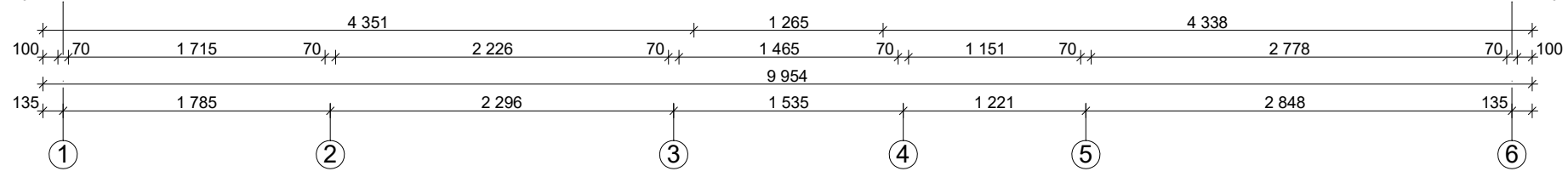
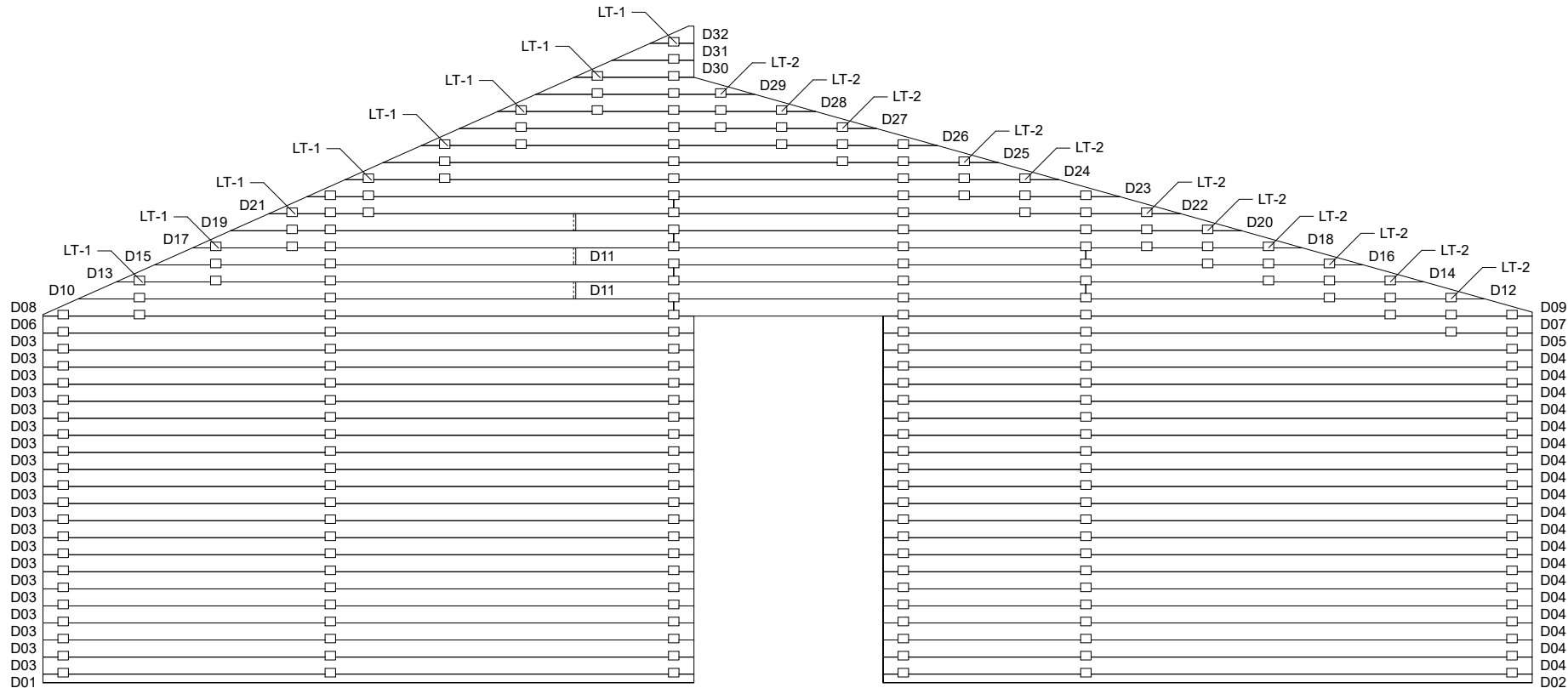

EZ LogV.3 62170071 / 934 x 1392 cm - E

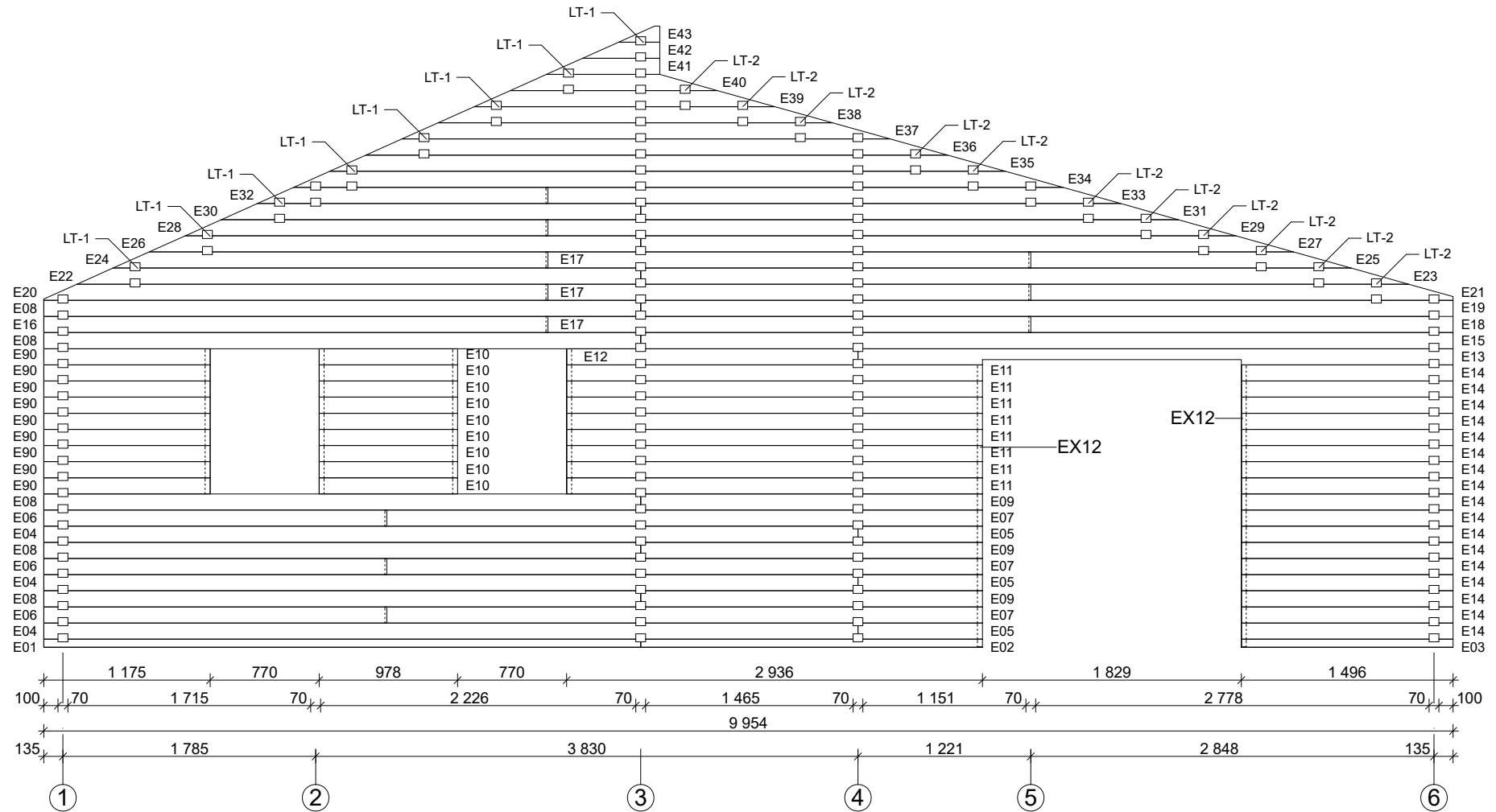

EZ LogV.3 62170071 / 934 x 1392 cm - 1 ; 2

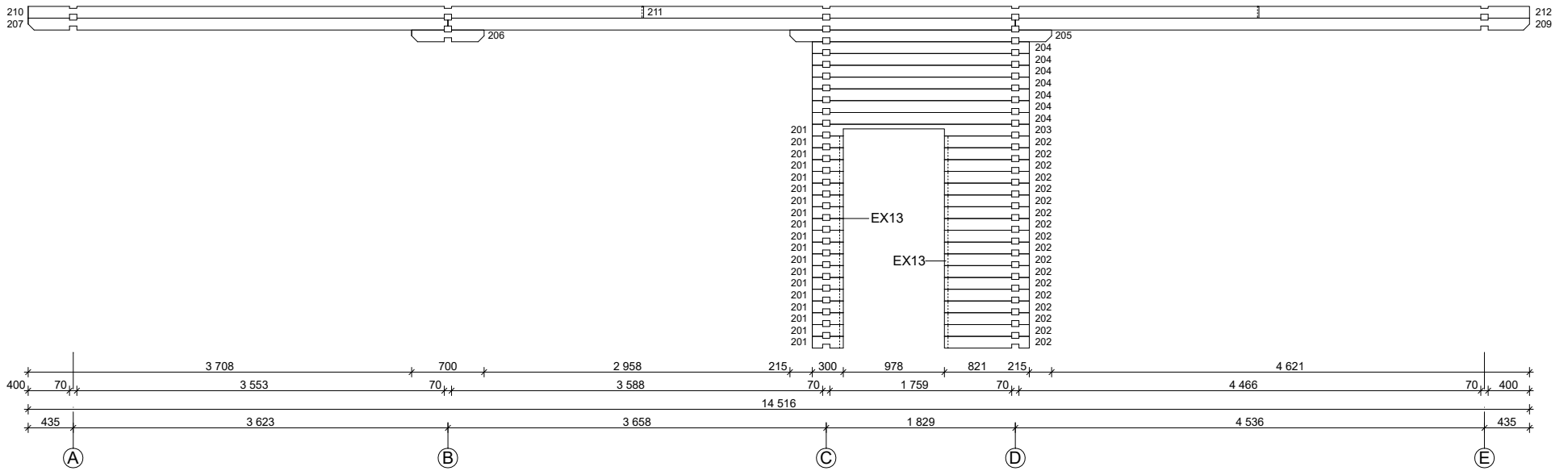
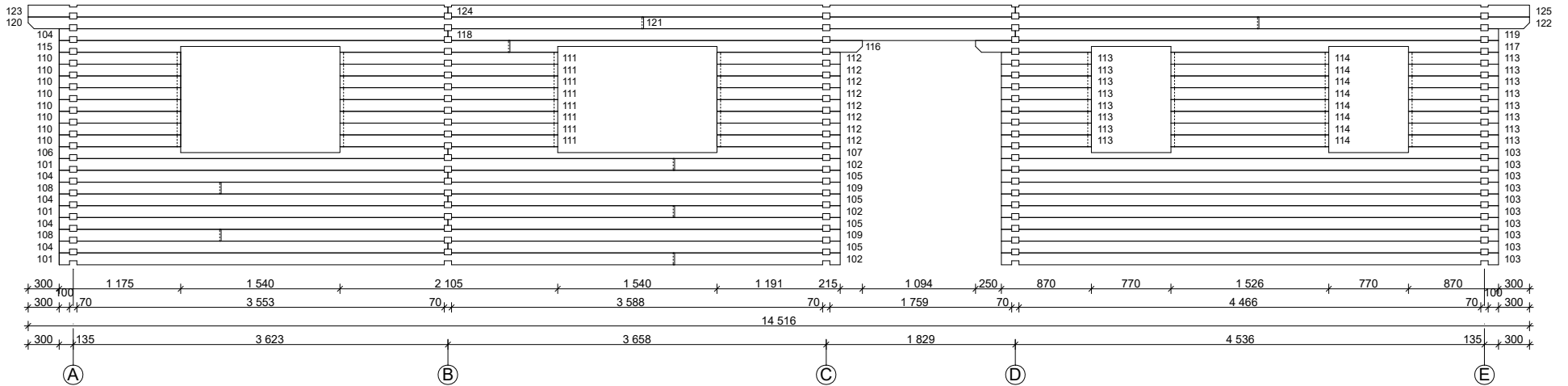

EZ LogV.3 62170071 / 934 x 1392 cm - LT

LT-1

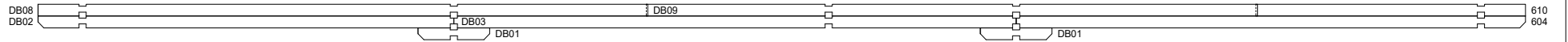

LT-2

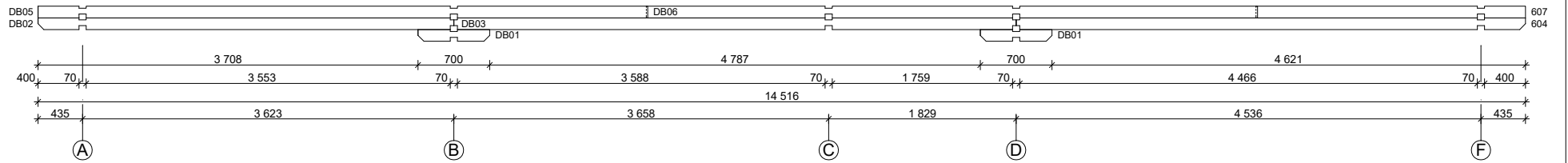



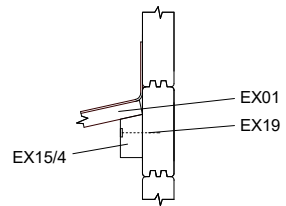



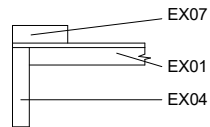





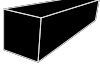
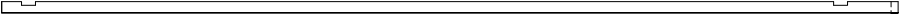
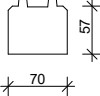
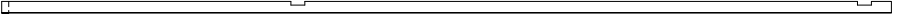

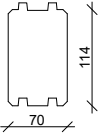
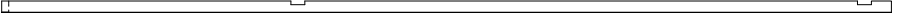



C-C















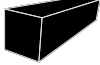

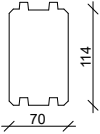
B-B

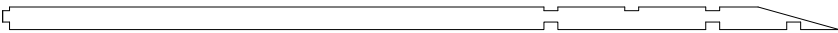
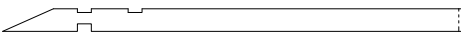
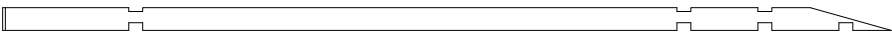
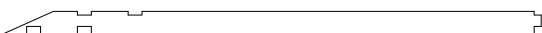



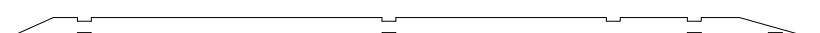
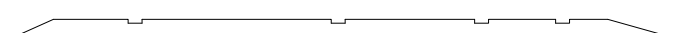
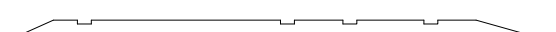

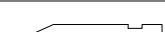
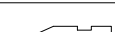









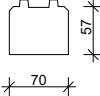
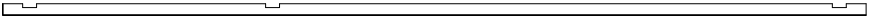

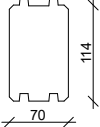

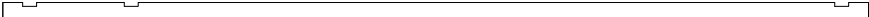

EZ Log V.3 62170071 / 934 x 1392 cm - A

Nr.		 mm	 mm	 ×
A01			4505	1
A02			4471	1
A03			4505	18
A04			4471	18
A05			3561	1
A06			3410+14	1
A07			2982	1
A08			4216	1
A09			5738	1
A10			3410+14	3
A11			2983	1
A12			4216	1
A13			5738	1
A14			3327	1
A15			2669	1
A16			3727	1
A17			5017	1











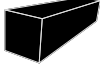



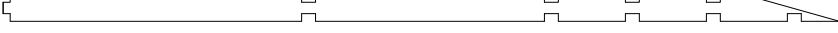
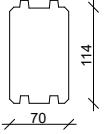

EZ Log V.3 62170071 / 934 x 1392 cm - A

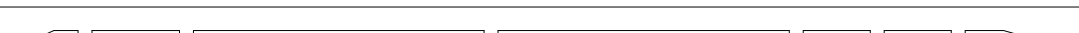
Nr.		 mm	 mm	 x
A18		 70 114	2817	1
A19			1855	1
A20			3217	1
A21			4203	1
A22			2307	1
A23			4451+14	1
A24			2706	1
A25			3390	1
A26			5434	1
A27			4772	1
A28			4110	1
A29			3448	1
A30			2787	1
A31			2125	1
A32			1463	1
A33		801	1	
A34		546	1	
A35		294	1	

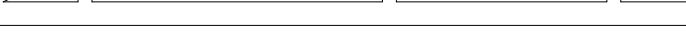

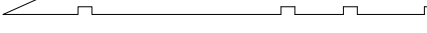

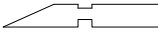
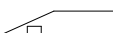





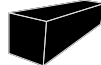

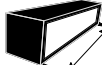
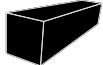
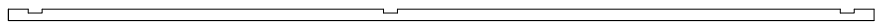
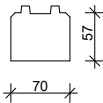
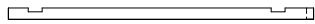
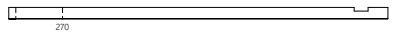
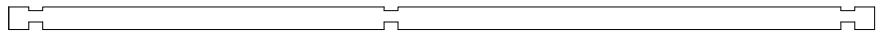
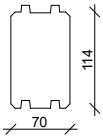
EZ Log V.3 62170071 / 934 x 1392 cm - B

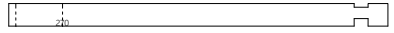
Nr.		 mm	 mm	 x
B01			4351	1
B02			4338	1
B03			4351	20
B04			4338	19
B05			4351	1
B06			4338	1
B07			4338	1
B08			4216	1
B09			5738	1
B10			3327	1
B11			3410+14	2
B12			2669	1
B13			3727	1
B14			5017	1
B15			2817	1
B16			1855	1
B17			3217	1

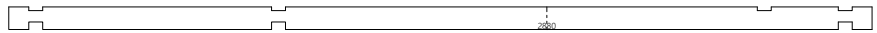
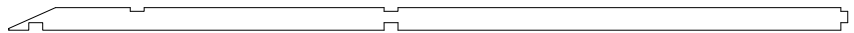
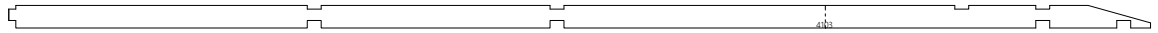

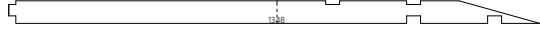



EZ Log V.3 62170071 / 934 x 1392 cm - B

Nr.		 mm	 mm	 x
B18			4203	1
B19			2307	1
B20			4451+14	1
B21			2706	1
B22			3390	1
B23			5434	1
B24			4772	1
B25			4110	1
B26			3448	1
B27			2787	1
B28			2125	1
B29			1463	1
B30			801	1
B31			546	1
B32		291	1	

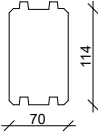
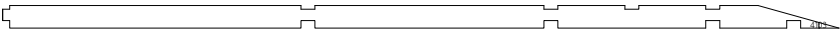
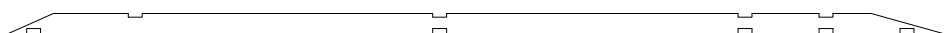

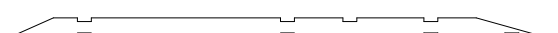











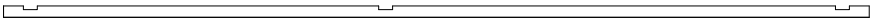
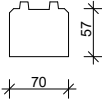

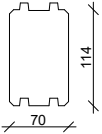
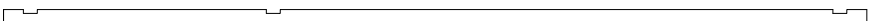

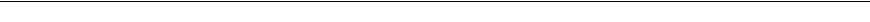
EZ Log V.3 62170071 / 934 x 1392 cm - C

Nr.		 mm	 mm	 ×
C01			4351	1
C02			1710	1
C03			1905	1
C04			4351	21
C05			1533	18
C06			1905	18
C07			4338	1
C08			4338	1
C09			4338	1
C10			4216	1
C11			5738	1
C12			3327	1
C13			3410+14	1
C14		2669	1	
C15		3727	1	
C16		5017	1	
C17		2817	1	





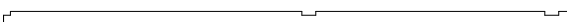





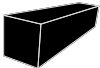

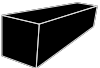

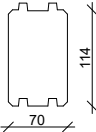

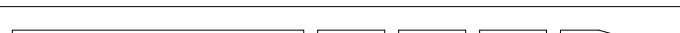
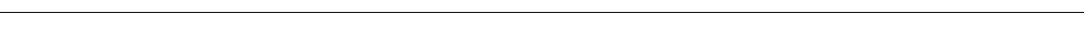

EZ Log V.3 62170071 / 934 x 1392 cm - C

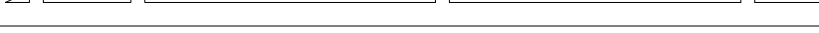
Nr.		 mm	 mm	 x
C18			1855	1
C19			3217	1
C20			4202	1
C21			2307	1
C23			2706	1
C24			3399	1
C25			5434	1
C26			4772	1
C27			4110	1
C28			3448	1
C29			2787	1
C30			2125	1
C31			1463	1
C32			801	1
C33		546	1	
C34		291	1	





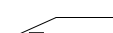





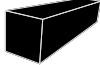



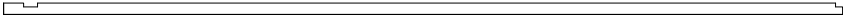
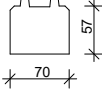



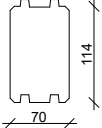

EZ Log V.3 62170071 / 934 x 1392 cm - D

Nr.		 mm	 mm	 x
D01			4351	1
D02			4338	1
D03			4351	20
D04			4338	19
D05			4338	1
D06			4351	1
D07			4338	1
D08			4216	1
D09			5738	1
D10			3327	1
D11			3410+14	1
D12			2669	1
D13			3727	1
D14			5017	1
D15			2817	1
D16			1855	1
D17			3217	1

EZ Log V.3 62170071 / 934 x 1392 cm - D

Nr.		 mm	 mm	 x
D18			4202	1
D19			2307	1
D20			4451+14	1
D21			2706	1
D22			3390	1
D23			5434	1
D24			4772	1
D25			4110	1
D26			3448	1
D27			2787	1
D28			2125	1
D29			1463	1
D30			801	1
D31		546	1	
D32		291	1	













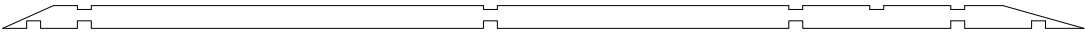
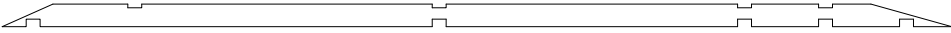

EZ Log V.3 62170071 / 934 x 1392 cm - E

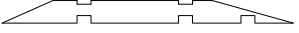
Nr.		 mm	 mm	 x
E01			4216	1
E02			2413	1
E03			1496	1
E04			5751	3
E05			879	3
E06			2423	3
E07			4206+14	3
E08			4216	5
E09			2413	3
E90			1175	9
E10			978	9
E11			2936	8
E12			2058	1
E13			4203	1
E14			1496	17
E15			5738	1
E16			3561	1

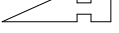

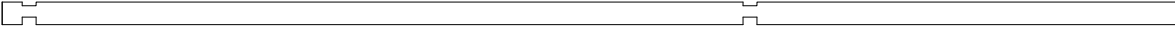
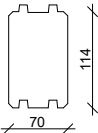
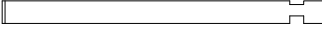
EZ Log V.3 62170071 / 934 x 1392 cm - E

Nr.		 mm	 mm	 x
E17			3410+14	3
E18			2983+14	1
E19			5738	1
E20			3561	1
E21			2983+14	1
E22			3982	1
E23			5424	1
E24			3072	1
E25			2262+14	1
E26			3472	1
E27			4610	1
E28			2562	1
E29			4858+14	1
E30			2962	1
E31			3796	1
E32		2051	1	
E33		4045+14	1	

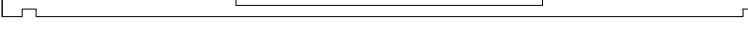



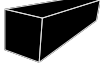
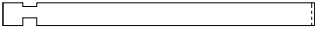
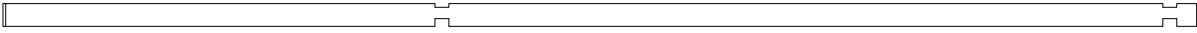
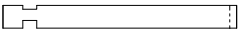









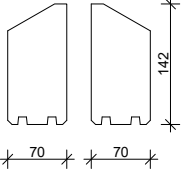

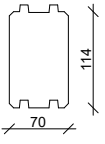

EZ Log V.3 62170071 / 934 x 1392 cm - E ; 1

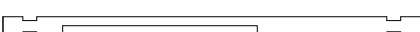
Nr.		 mm	 mm	 x
E34			5434	1
E35			4772	1
E36			4110	1
E37			3448	1
E38			2787	1
E39			2125	1
E40			1463	1
E41			801	1
E42			546	1
E43			291	1
101			5950	3
102			1601+14	3
103			4806	9
104			3758	4
105			3793	4
106			3758	1

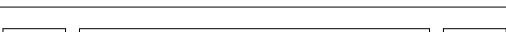
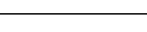



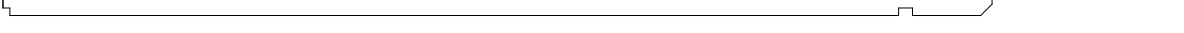
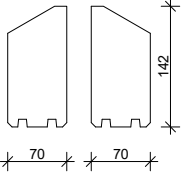

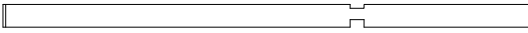







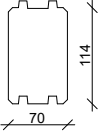

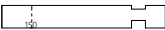

EZ Log V.3 62170071 / 934 x 1392 cm - 1

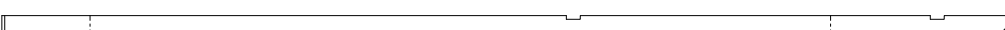
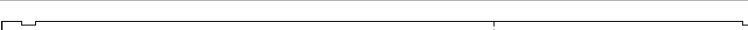
Nr.		 mm	 mm	 x
107			3793	1
108			1566	2
109			5985+14	2
110			1175	8
111			2105	8
112			1191	8
113			870	16
114			1526	8
115			4358	1
116			3408+14	1
117			5056	1
118			5487	1
119			4671	1
120			5950	1
121		5950+14	1	
122		2616+14	1	

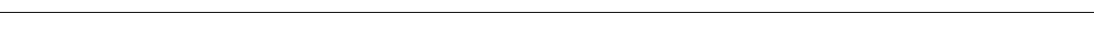

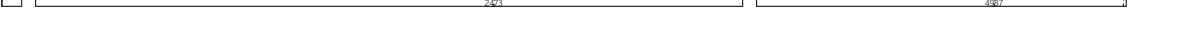







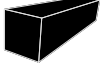

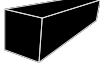

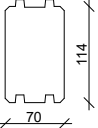
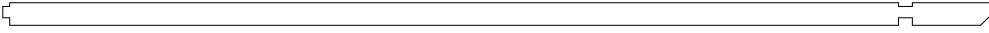
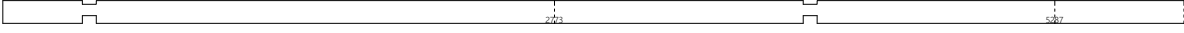
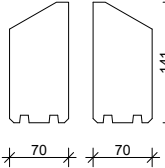

EZ Log V.3 62170071 / 934 x 1392 cm - 1 ; 2

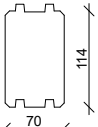
Nr.		 mm	 mm	 ×
123			4058	1(1+0)
124			5487	1(1+0)
125			4971	1(1+0)
201			300	18
202			821	18
203			2099	1
204			2099	7
205			2529	1
206			700	1
207			4058	1
208			5487	1
209			4971	1
210				5950
211		5950+14		1(1+0)
212		2616+14		1(1+0)





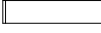

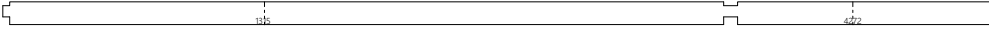



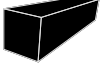

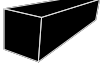

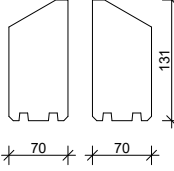

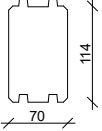

EZ Log V.3 62170071 / 934 x 1392 cm - 3

Nr.		 mm	 mm	 x
301			2623	19
302			1614	19
303			1544	19
304			821	19
305			3343	1
306			4558	5
307			4822+14	4
308			5037+14	1
309			3758	8
310			5622	4
311			5487	5
312			4671	4
313			5650	4
314			5950+14	4
315			259	27
316			474	1
317			2316+14	4





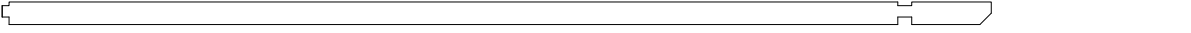
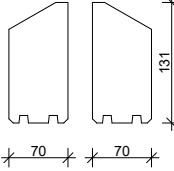







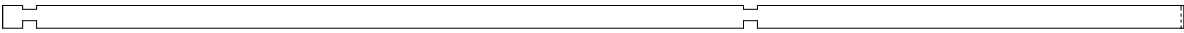
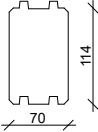
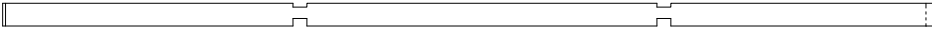

EZ Log 62170071 / 934 x 1392 cm - 3 ; 4

Nr.		 mm	 mm	 x
318			4058	1
319			4971	1
320			5950	1(1+0)
321			5950+14	1(1+0)
322			2616+14	1(1+0)
401			400	19
402			3257	19
403			300	19
404			259	29
405			5757	10
406			2246	1
407			3945+14	1
408			474	1
409			4058	1
410			5487	1
411			4971	1

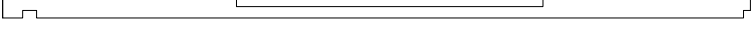
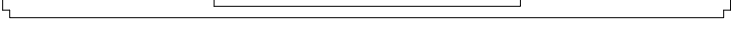
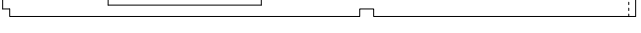
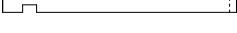
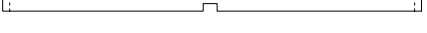



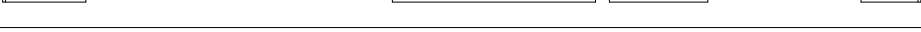

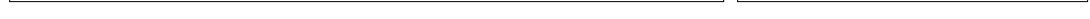







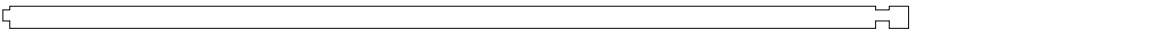
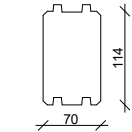

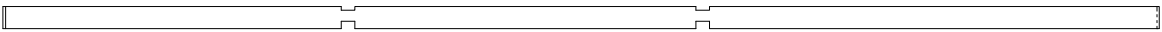

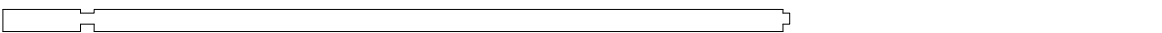
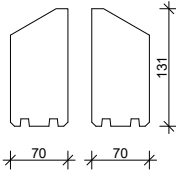
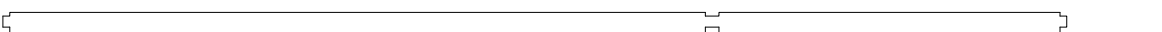
EZ Log 62170071 / 934 x 1392 cm - 4 ; 5

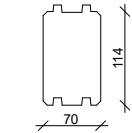
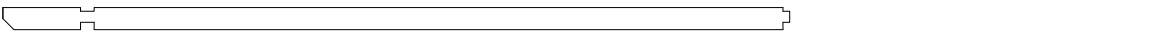
Nr.		 mm	 mm	 ×
412			5950	1(0+1)
413			5950+14	1(0+1)
414			2616+14	1(0+1)
501			400	19
502			2593	19
503			2099	26
504			3893	7
505			4108	1
506			2529	1
507			4058	1
508			5487	1
509			4971	1
510				5950
511		5950+14		1(0+1)
512		2616+14		1(0+1)

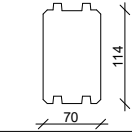
EZ Log V.3 62170071 / 934 x 1392 cm - 6

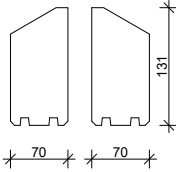
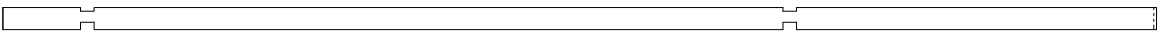
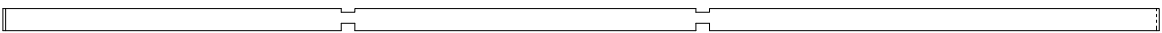
Nr.		 mm	 mm	 x
601			5936	5
602			4661+14	5
603			1490	17
604			3758	5
605			3658	4
606			3181	4
607			3758	1
608			3658	1
609			3181	1
610			1175	8
611			2105	8
612			1586	8
613			1882	8
614			5200	1
615			4416	1
616			4600+14	1
617			4900+14	1
618			5487	1

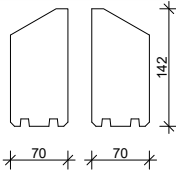
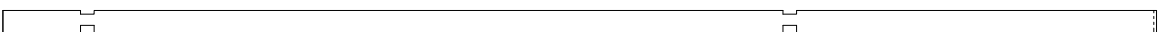
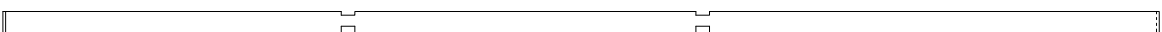
EZ Log V.3 62170071 / 934 x 1392 cm - 6 ; LT

Nr.		 mm	 mm	 x
619			4671	1
620			5950	1
621			5950+14	1
622			2616+14	1
623			4058	1(0+1)
624			5487	1(0+1)
625			4971	1(0+1)
DB01			700	30
DB02			4058	15
DB03			5487	15
DB04			4971	15
DB05			5950	9(0+9)
DB06			5950+14	9(0+9)
DB07			2616+14	9(0+9)
DB08			5950	6(6+0)
DB09			5950+14	6(6+0)
DB10			2616+14	6(6+0)
EXDR			5950	3