

# Denver 2 1 1/8" (90 9/16" x 90 9/16")

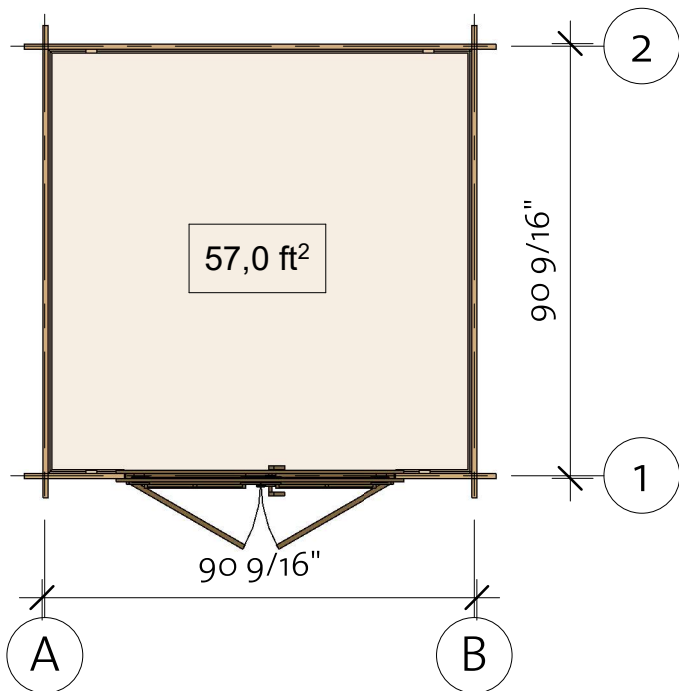
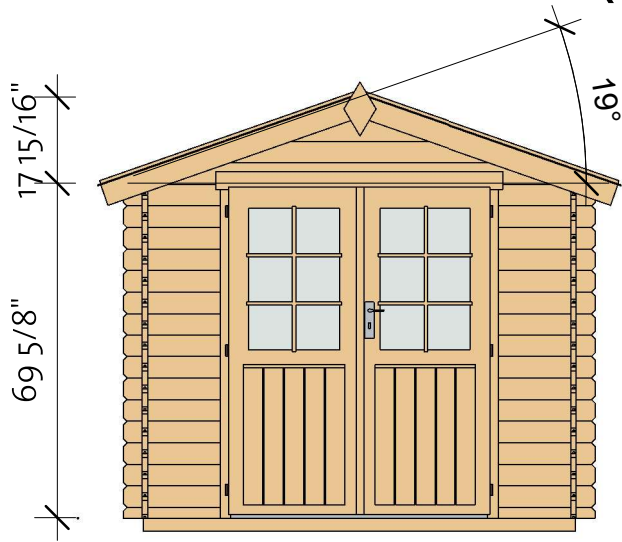

190418

# Denver 2 1 1/8" (90 9/16" x 90 9/16")

Foundation

Impregnated foundation beams				
Mark	Type	Profile	Count	Length

IFB	IFB 40x70		5	90 3/16"
-----	--------------	---	---	-------------

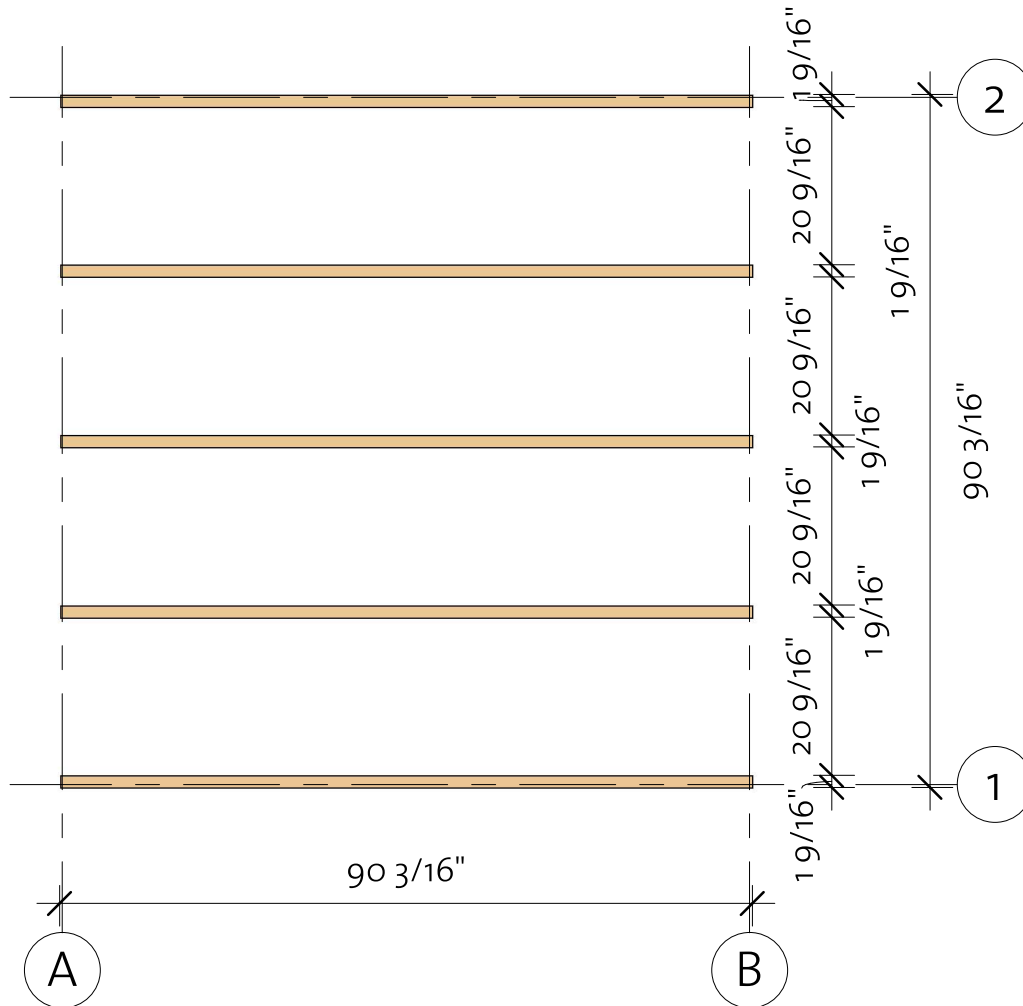



# Denver 2 1 1/8" (90 9/16" x 90 9/16")

Floor Plan

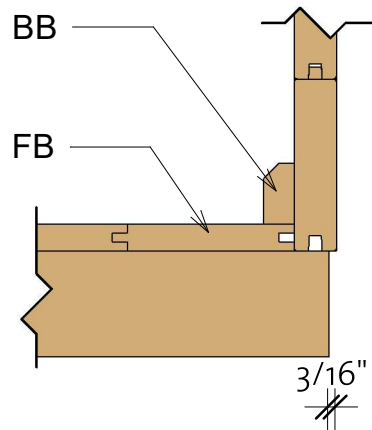
① Baseboard



Floor Schedule				
Mark	Type	Profile	Count	Length
FB	FB 18x110		22	88 3/16"
BB	BB 20x40		4	86 5/8"

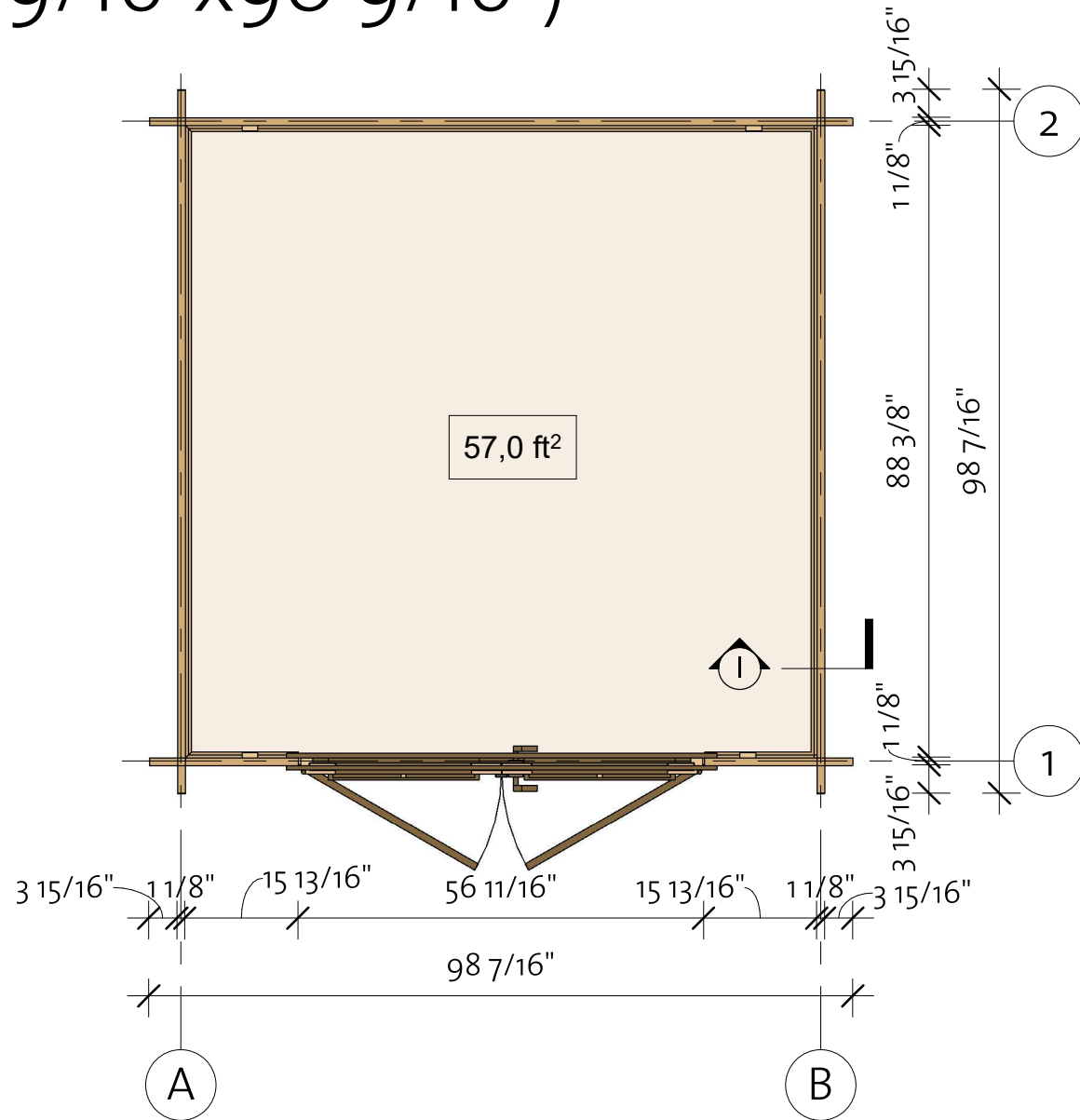

# Denver 2 1 1/8" (90 9/16" x 90 9/16")

Wall 1

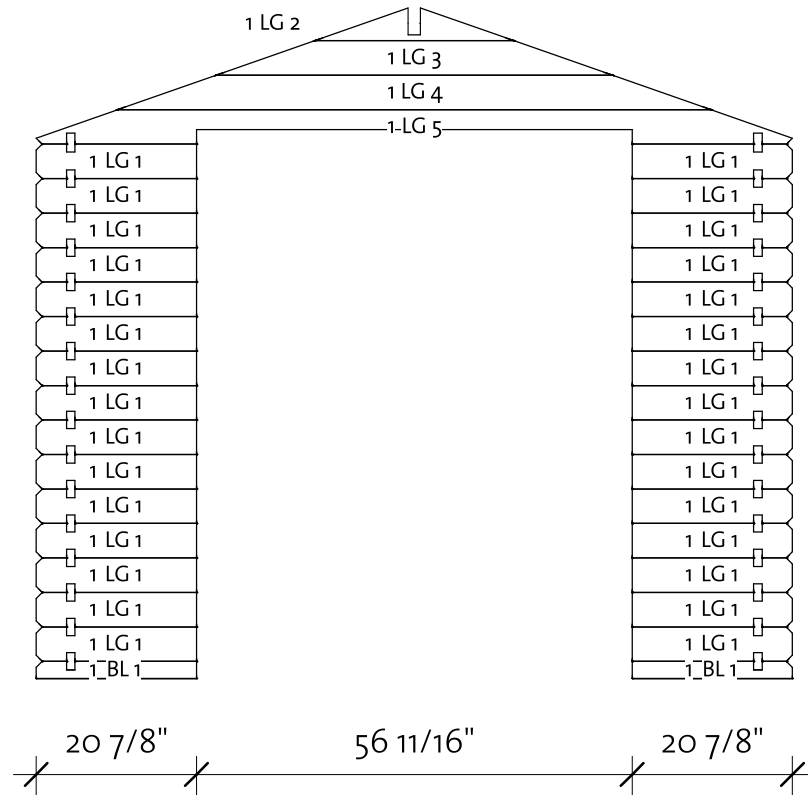
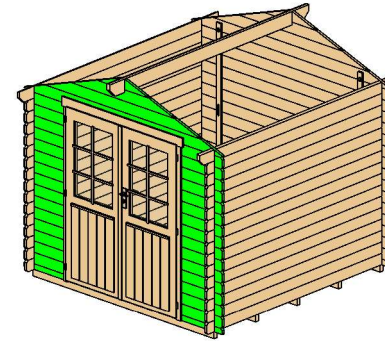

Wall 1			
Mark	Profile	Count	Cut Length

1BL 1	28x57	2	20 7/8"
1LG 1	28x114	30	20 7/8"
1LG 2*	28x114	1	25 15/16"
1LG 3*	28x114	1	51 9/16"
1LG 4*	28x114	1	77 1/4"
1LG 5*	28x114	1	98 7/16"

\* Gable - delivered premounted

Log Profile Wall 1	
Profile	Profile

28x57	
28x114	

# Denver 2 1 1/8" (90 9/16" x 90 9/16")

Wall 2

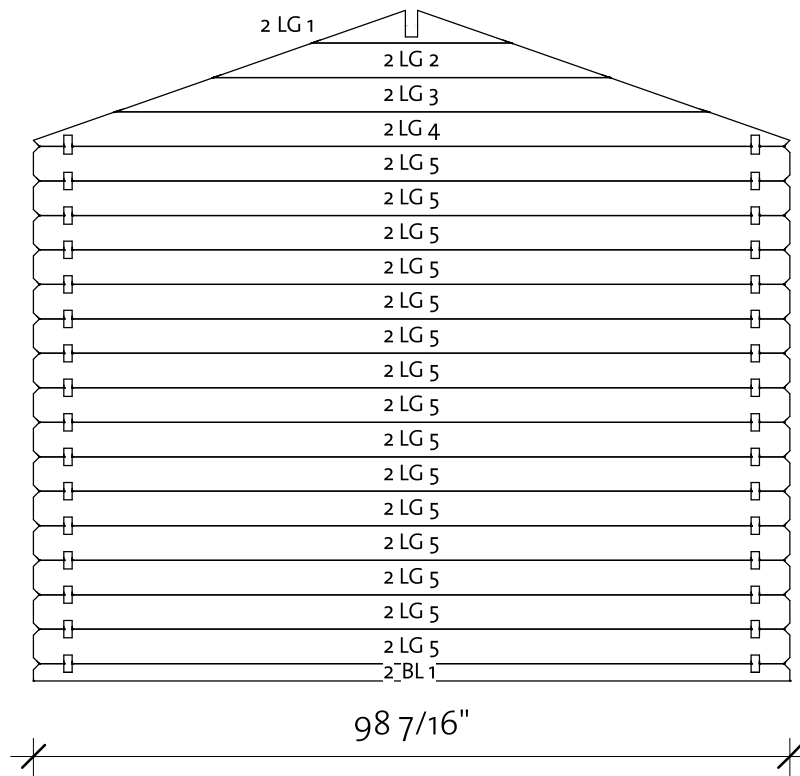
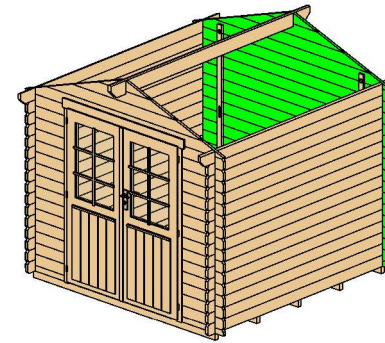

Wall 2			
Mark	Profile	Count	Cut Length

2BL 1	28x57	1	98 7/16"
2LG 1*	28x114	1	25 15/16"
2LG 2*	28x114	1	51 9/16"
2LG 3*	28x114	1	77 1/4"
2LG 4*	28x114	1	98 7/16"
2LG 5	28x114	15	98 7/16"

\* Gable - delivered premounted

Log Profile Wall 2	
Profile	Profile

28x57	
28x114	

# Denver 2 1 1/8" (90 9/16"x90 9/16")

Wall A

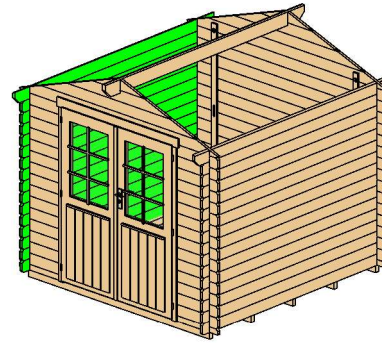

Wall A			
Mark	Profile	Count	Cut Length
ALG 1	28x114	15	98 7/16"
ATL 1	28x122	1	106 5/16"

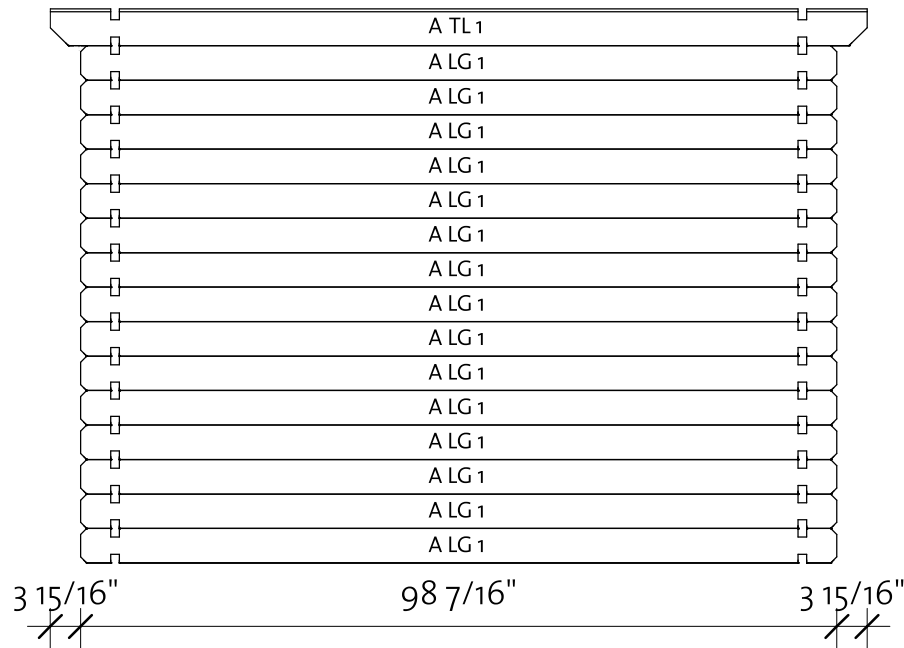

Log Profile Wall A	
Profile	Profile



28x114	
28x122	

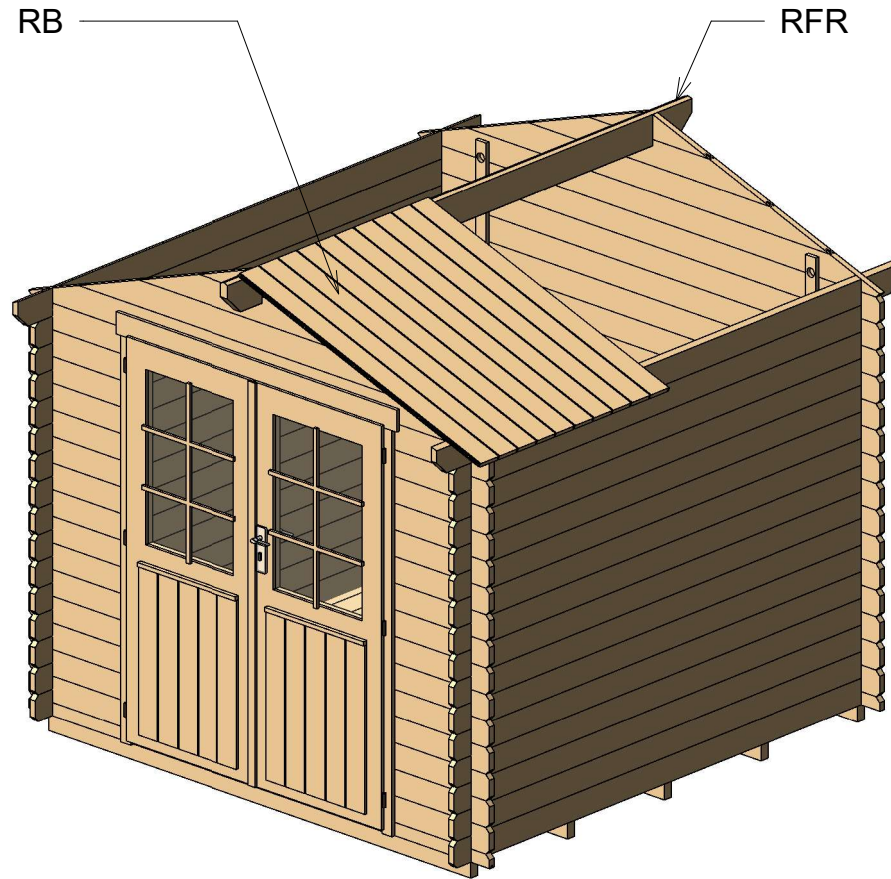

# Denver 2 1 1/8" (90 9/16"x90 9/16")

Roof 1



Roof				
Mark	Type	Profile	Count	Length
RFR	Ridge 40x143		1	106 5/16"
RB	Roofboard 18x110		52	54 5/16"



# Denver 2 1 1/8" (90 9/16"x90 9/16")

Roof 2

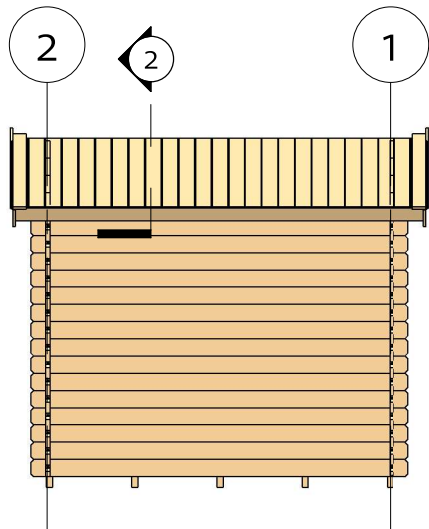

② Fascia

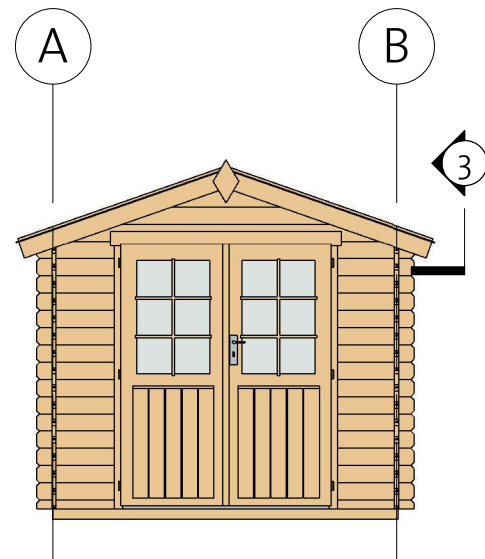
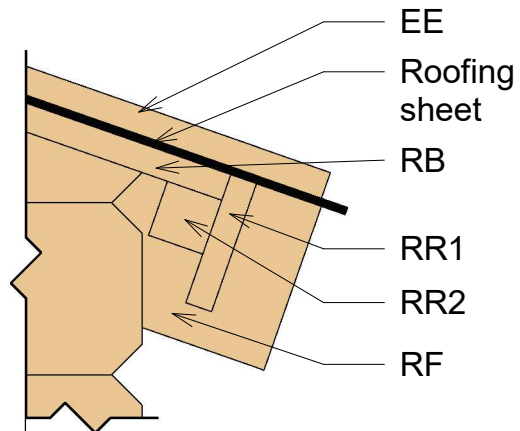

③ Roof Reinforcement

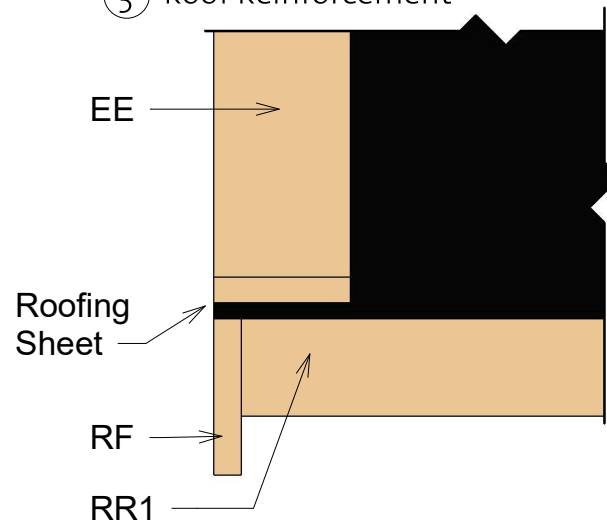

Fascia Schedule

Mark	Type	Profile	Count	Length
EE	Eave Edging 18x90		4	57 1/16"
RF	Roof Fascia 18x115		4	57 1/16"
RR1	Roof reinforcement 18x90		2	106 5/16"
RR2	Roof reinforcement 38x38		2	106 5/16"

# Denver 2 1 1/8" (90 9/16" x 90 9/16")

Extras

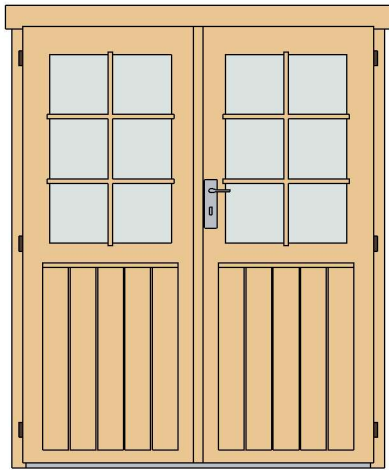

Door Schedule				
Model	Type	Width	Height	Count
BDD3R	Basic double door 3 right	56 1/8"	69 7/8"	1
DCB6	Door crossbar 6	--	--	2



Type	Count	Lenght
------	-------	--------

Windboard 18x40	4	86 5/8"
-----------------	---	---------

Fasteners/Extras		
Name	Type	Count

Hitblock	11 13/16"-15 3/4"	
Screws	3/16" x 2 3/4"	10
Bolts	M5/16" x 2 3/8"	12
Screws	1/4" x 5 1/2"	25
Nails	1/16" x 1 9/16"	25
Screws	3/16" x 1 9/16"	75
Screws	3/16" x 2"	250



Family	Count
--------	-------

Romb	2
------	---



# Denver 2 1 1/8" (90 9/16"x90 9/16")

## List of all items 1



Impregnated foundation beams				
Mark	Type	Profile	Count	Length

IFB	IFB 40x70		5	90 3/16"
-----	--------------	---	---	-------------





Floor Schedule				
Mark	Type	Profile	Count	Length

FB	FB 18x110		22	88 3/16"
BB	BB 20x40		4	86 5/8"

Roof				
Mark	Type	Profile	Count	Length

RFR	Ridge 40x143		1	106 5/16"
RB	Roofboard 18x110		52	54 5/16"

Fascia Schedule				
Mark	Type	Profile	Count	Length

EE	Eave Edging 18x90		4	57 1/16"
RF	Roof Fascia 18x115		4	57 1/16"
RR1	Roof reinforcement 18x90		2	106 5/16"
RR2	Roof reinforcement 38x38		2	106 5/16"

# Denver 2 1 1/8" (90 9/16"x90 9/16")

## List of all items 2

Wall 1			
Mark	Profile	Count	Cut Length

1BL 1	28x57	2	20 7/8"
1LG 1	28x114	30	20 7/8"
1LG 2*	28x114	1	25 15/16"
1LG 3*	28x114	1	51 9/16"
1LG 4*	28x114	1	77 1/4"
1LG 5*	28x114	1	98 7/16"

Wall 2			
Mark	Profile	Count	Cut Length

2BL 1	28x57	1	98 7/16"
2LG 1*	28x114	1	25 15/16"
2LG 2*	28x114	1	51 9/16"
2LG 3*	28x114	1	77 1/4"
2LG 4*	28x114	1	98 7/16"
2LG 5	28x114	15	98 7/16"

Wall A			
Mark	Profile	Count	Cut Length

ALG 1	28x114	15	98 7/16"
ATL 1	28x122	1	106 5/16"

Wall B			
Mark	Profile	Count	Cut Length

BLG 1	28x114	15	98 7/16"
BTL 1	28x122	1	106 5/16"

\* Gable - delivered premounted

Log Profiles	
Profile	Profile

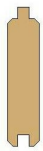
28x57	
28x114	
28x122	