

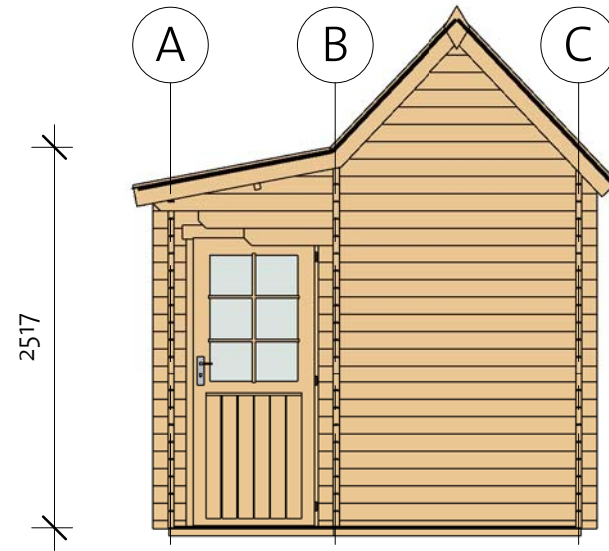

# Laker Shed 40 (274x454)

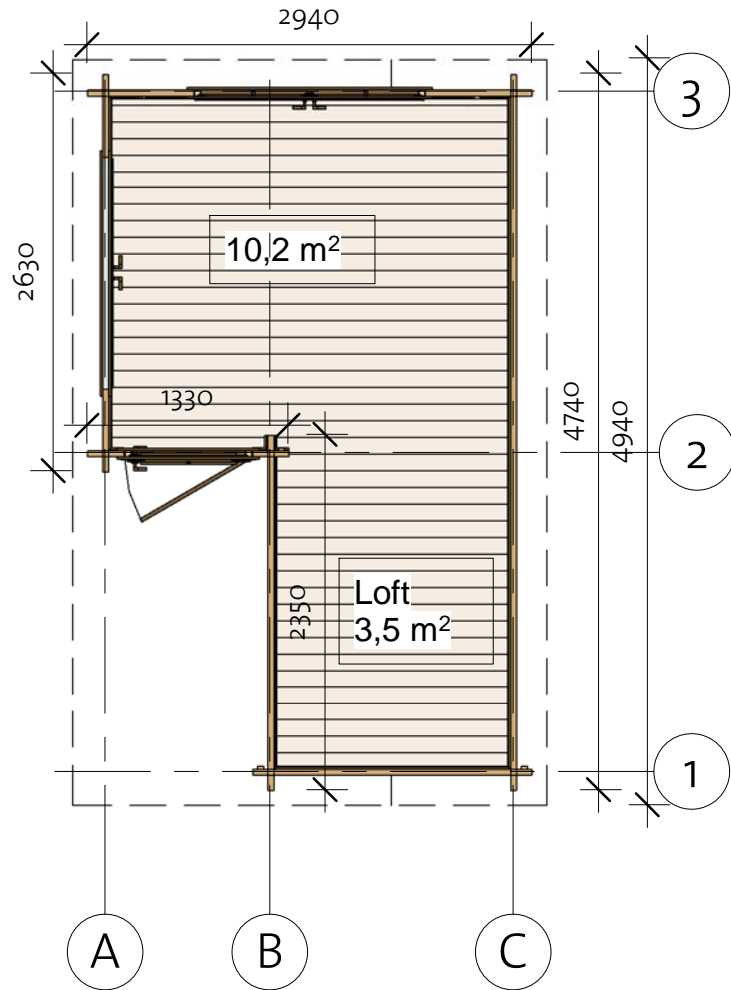
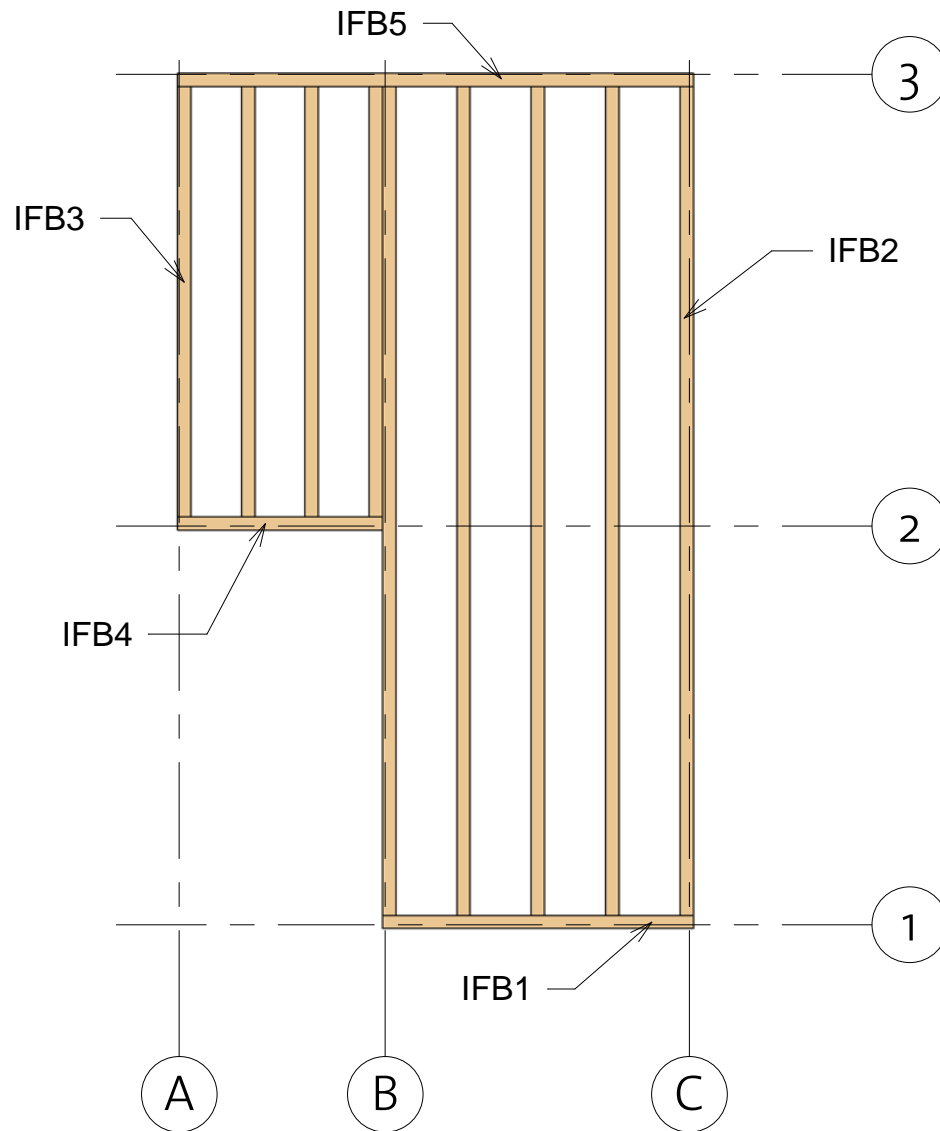

# Laker Shed 40 (274x454)

Foundation



Impregnated foundation beams				
Mark	Type	Profile	Count	Length
IFB1	IFB 70x45		1	1640
IFB2	IFB 70x45		5	4390
IFB3	IFB 70x45		4	2279
IFB4	IFB 70x45		1	1090
IFB5	IFB 70x45		1	2730

# Laker Shed 40 (274x454)

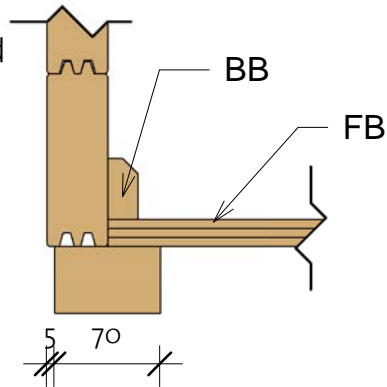

Floor Plan

① Baseboard



Floor Schedule

Mark	Type	Profile	Count	Length
------	------	---------	-------	--------

FB1	FB 18x110		20	1565
FB2	FB 18x110		23	2655
FB3	FB 18x110		7	2110
FB4	FB 18x110		10	2065
BB1	BB 20x40		2	4800
BB2	BB 20x40		2	4300
BB3	BB 20x40		2	3000

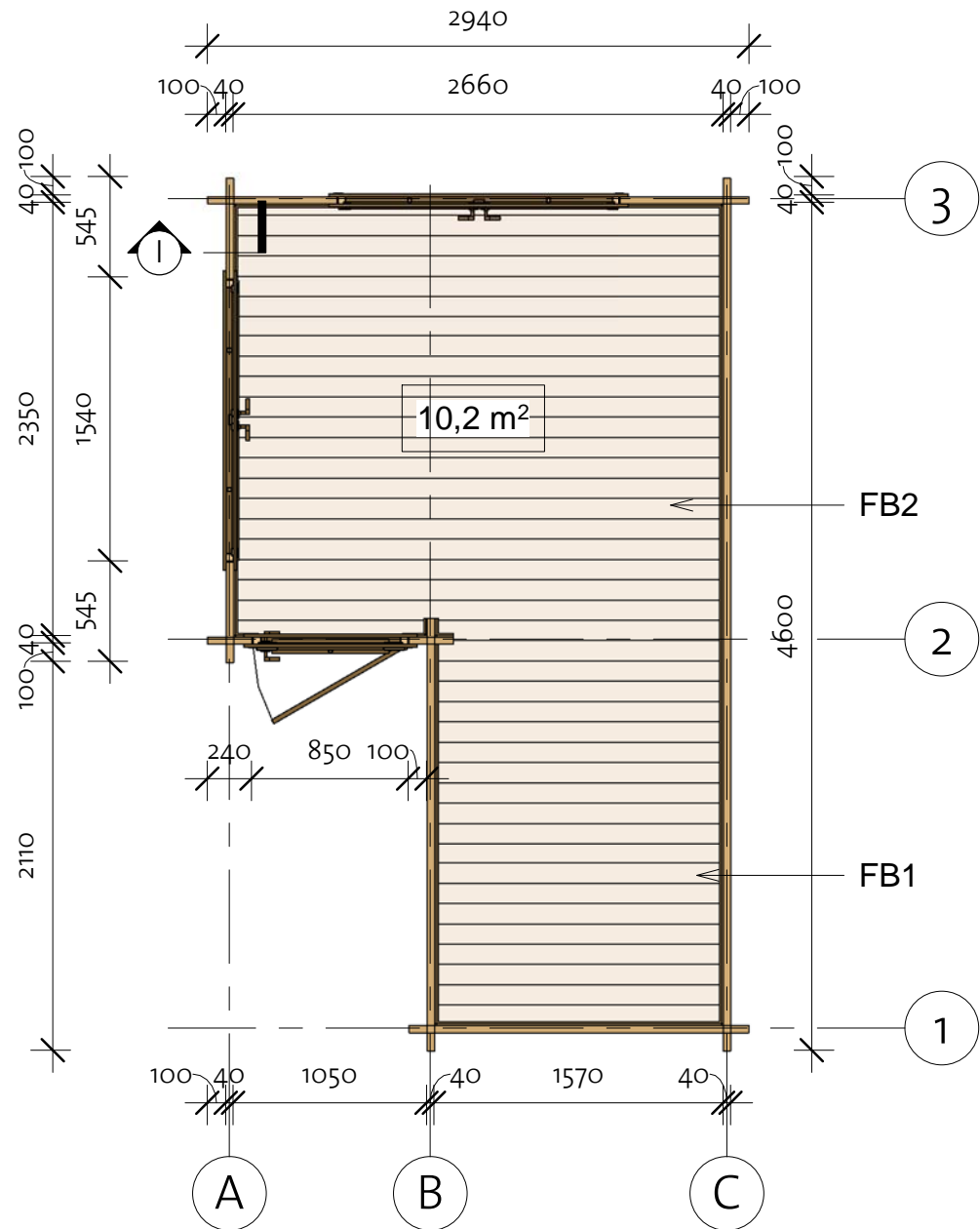

# Laker Shed 40 (274x454)

Wall 1

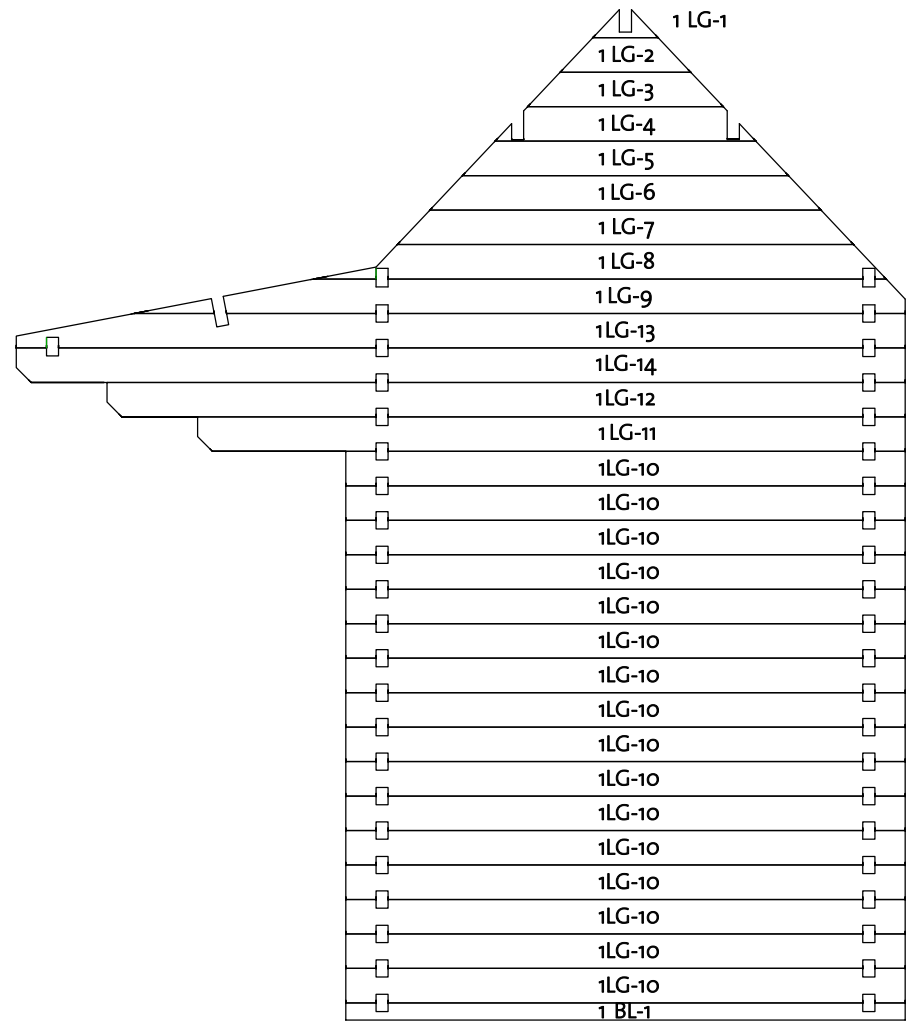

Wall 1			
Mark	Profile	Count	Cut Length

1BL-1	40X57	1	1850
1LG-1 *	40X114	1	216
1LG-2 *	40X114	1	431
1LG-3 *	40X114	1	647
1LG-4 *	40X114	1	863
1LG-5 *	40X114	1	1078
1LG-6 *	40X114	1	1294
1LG-7 *	40X114	1	1509
1LG-8 *	40X114	1	1894
1LG-9	40X114	1	2550
1LG-10	40X114	16	1850
1LG-11	40X114	1	2340
1LG-12	40X114	1	2640
1LG-13	40X114	1	2940
1LG-14	40X114	1	2940

\* Gable - delivered premounted

Log Profile Wall 1	
Profile	Profile



Log Profile Wall 1	
Profile	Profile

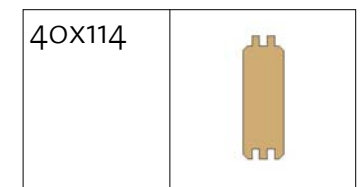

# Laker Shed 40 (274x454)

Wall 2

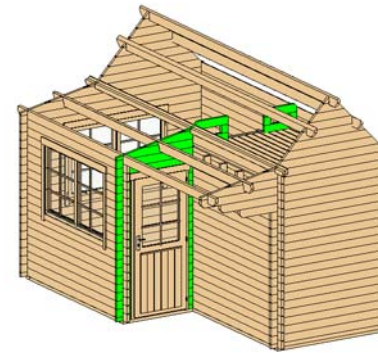

Wall 2			
Mark	Profile	Count	Cut Length

2BL-1	40X57	2	240
2LG-1	40X114	1	940
2LG-2	40X114	34	240
2LG-3	40X114	1	1735
2LG-4	40X114	1	2940
2LG-5	40X114	1	2940
2LG-6	40X114	1	645
2LG-7	40X114	2	100
2LG-8	40X114	1	240
2LG-9	40X114	1	751
2LG-10	40X114	1	582

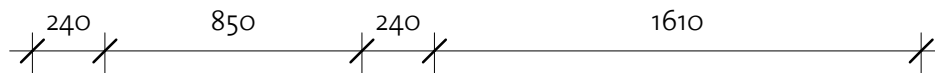
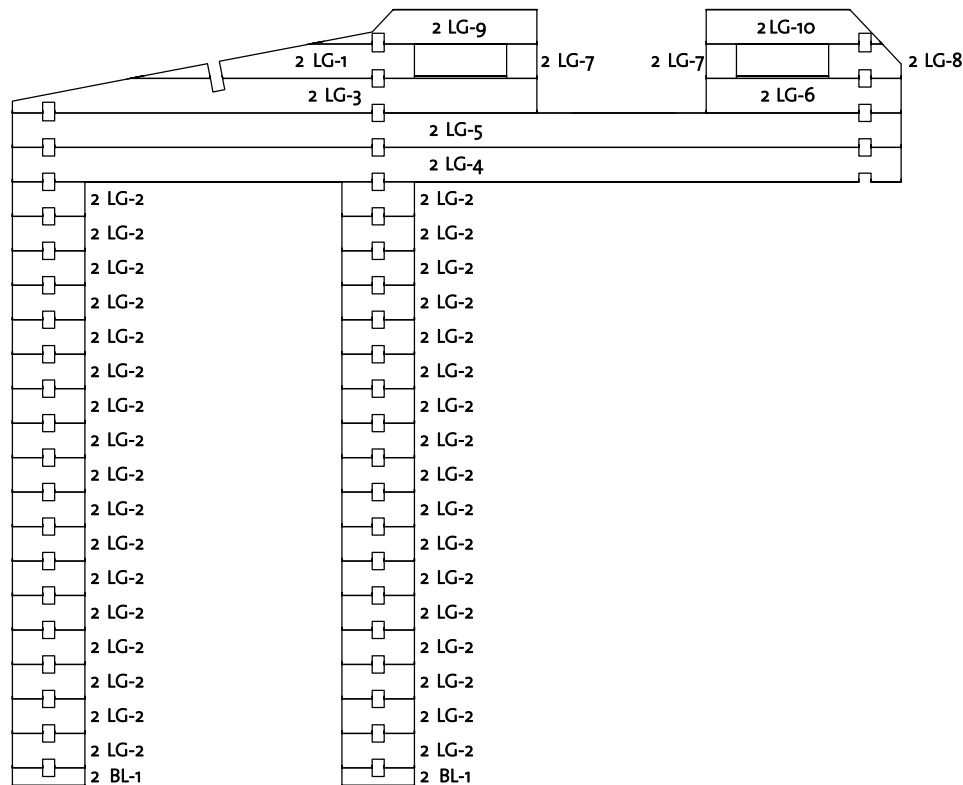

Log Profile Wall 2	
Profile	Profile



Log Profile Wall 2	
Profile	Profile

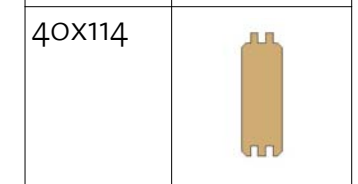

# Laker Shed 40 (274x454)

Wall 3

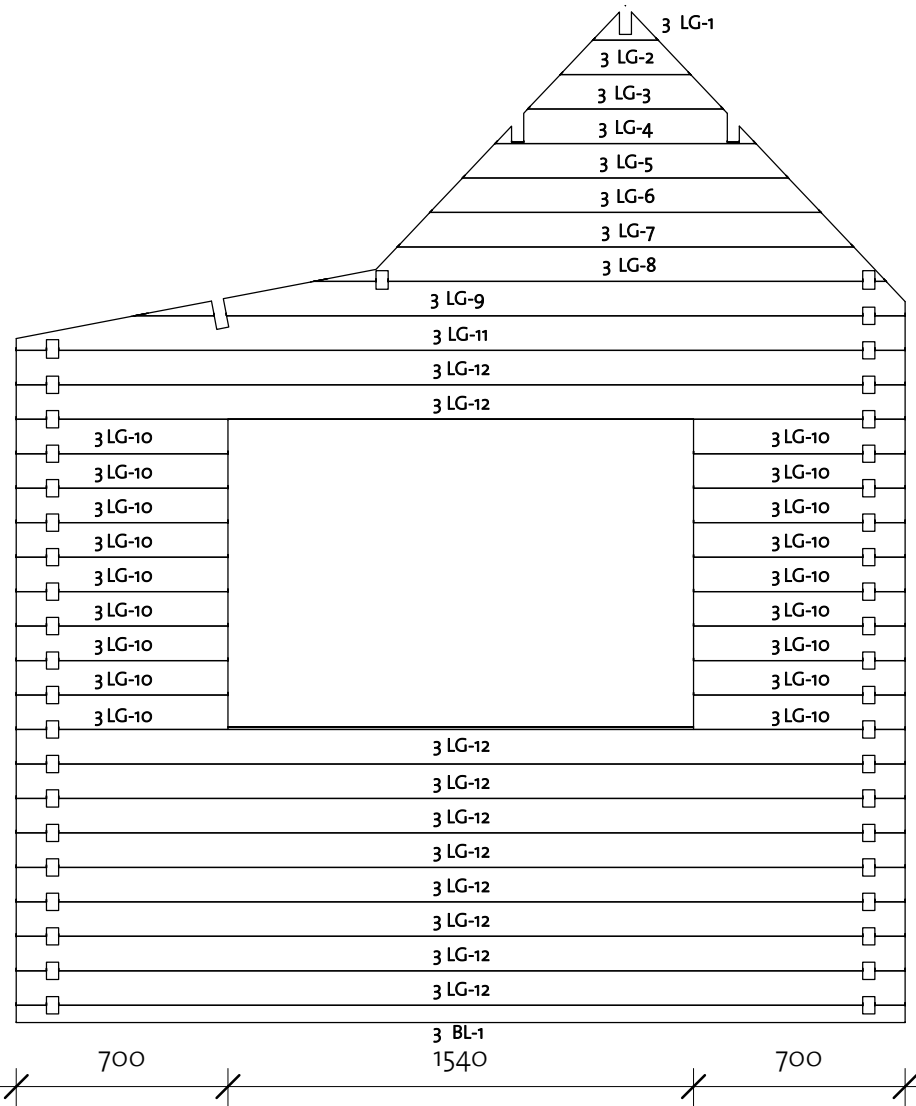

Wall 3			
Mark	Profile	Count	Cut Length

3BL-1	40X57	1	2940
3LG-1*	40X114	1	216
3LG-2*	40X114	1	431
3LG-3*	40X114	1	647
3LG-4*	40X114	1	863
3LG-5*	40X114	1	1078
3LG-6*	40X114	1	1294
3LG-7*	40X114	1	1509
3LG-8*	40X114	1	1894
3LG-9	40X114	1	2550
3LG-10	40X114	18	700
3LG-11	40X114	1	2940
3LG-12	40X114	10	2940

\* Gable - delivered premounted

Log Profile Wall 3	
Profile	Profile



Log Profile Wall 3	
Profile	Profile

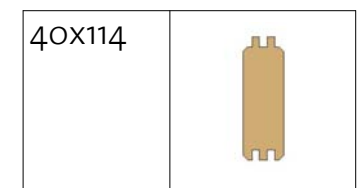

# Laker Shed 40 (274x454)

Wall A



Wall A			
Mark	Profile	Count	Cut Length

ALG-1	40X114	16	545
ALG-2	40X114	9	2630
ALG-3	40X114	1	2630
ALG-4	40X114	1	2630
ATL-1	40X123	1	4940

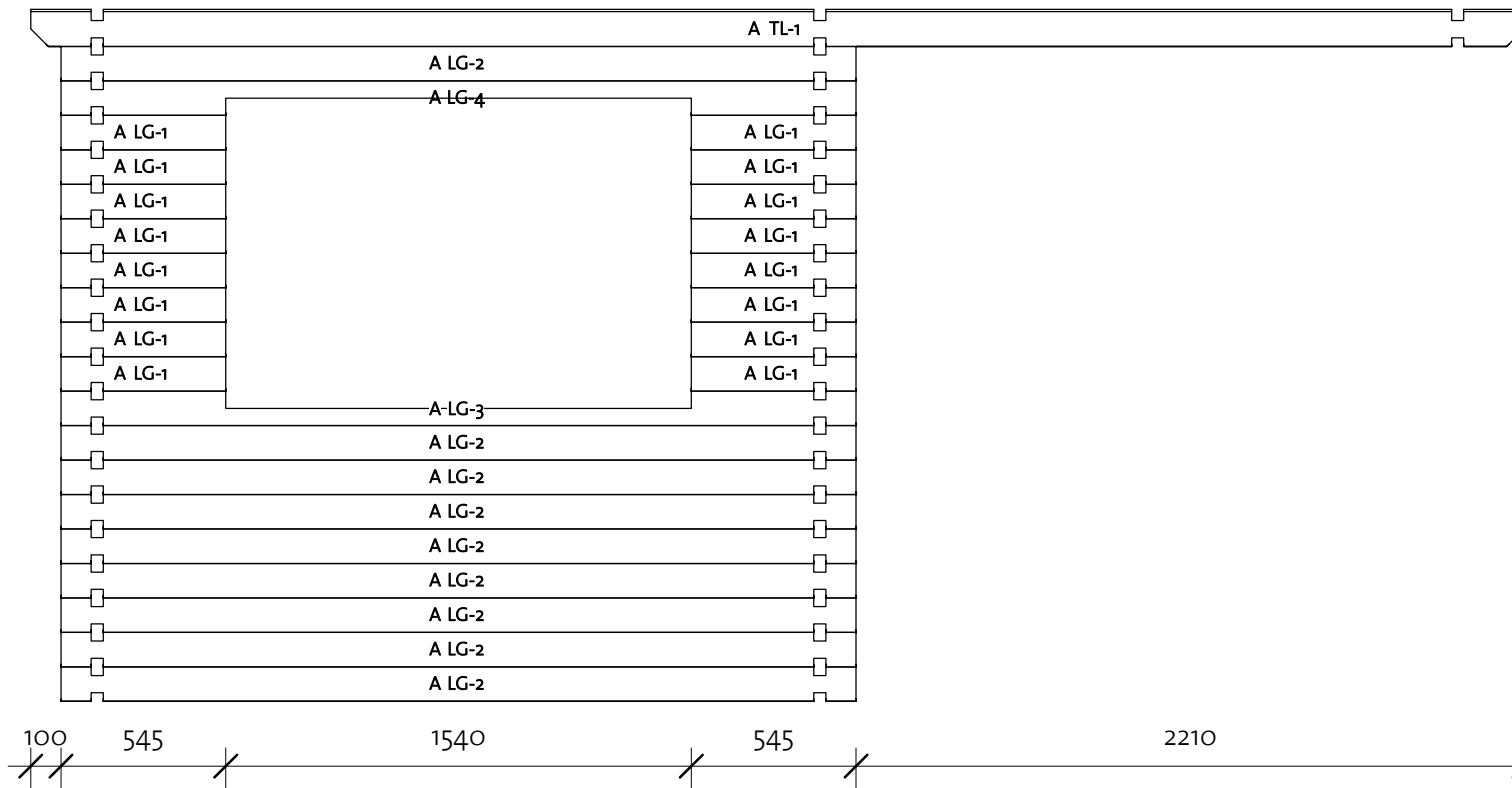

Log Profile Wall A	
Profile	Profile

40X114	
40X123	





# Laker Shed 40 (274x454)

Wall C

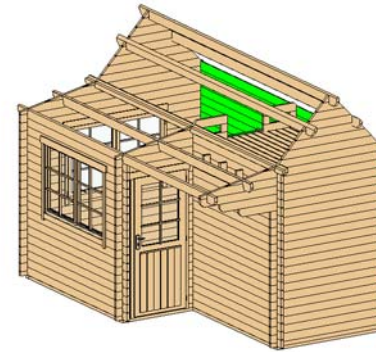

Wall C			
Mark	Profile	Count	Cut Length

CLG-1	40X114	17	4740
CLG-2	40X114	1	4740
CLG-3	40X114	1	4740
CLG-4	40X114	1	4740
CLG-5	40X114	1	4740
CTL-1	40X123	1	4940

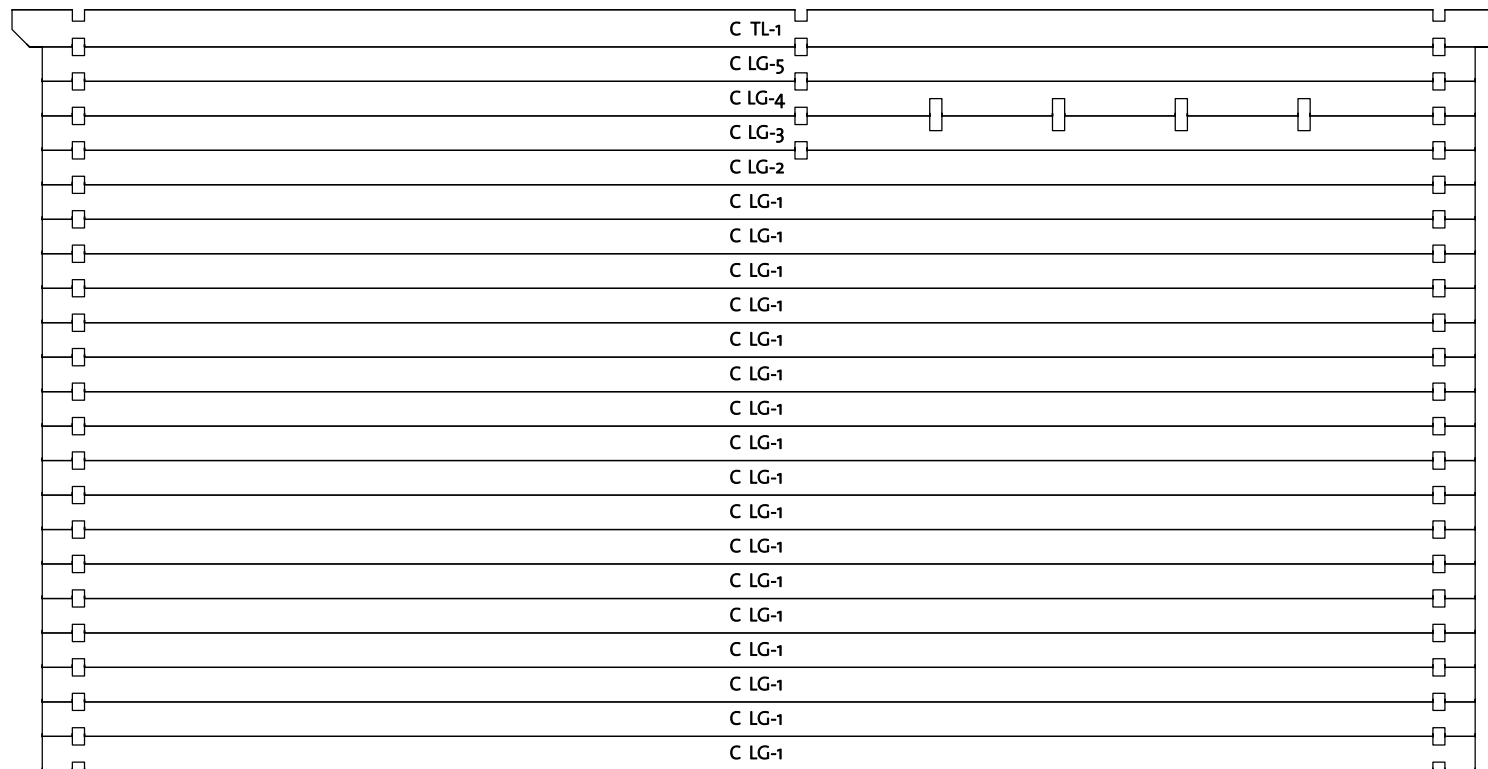

Log Profile Wall C	
Profile	Profile



40X114	
40X123	

# Laker Shed 40 (274x454)

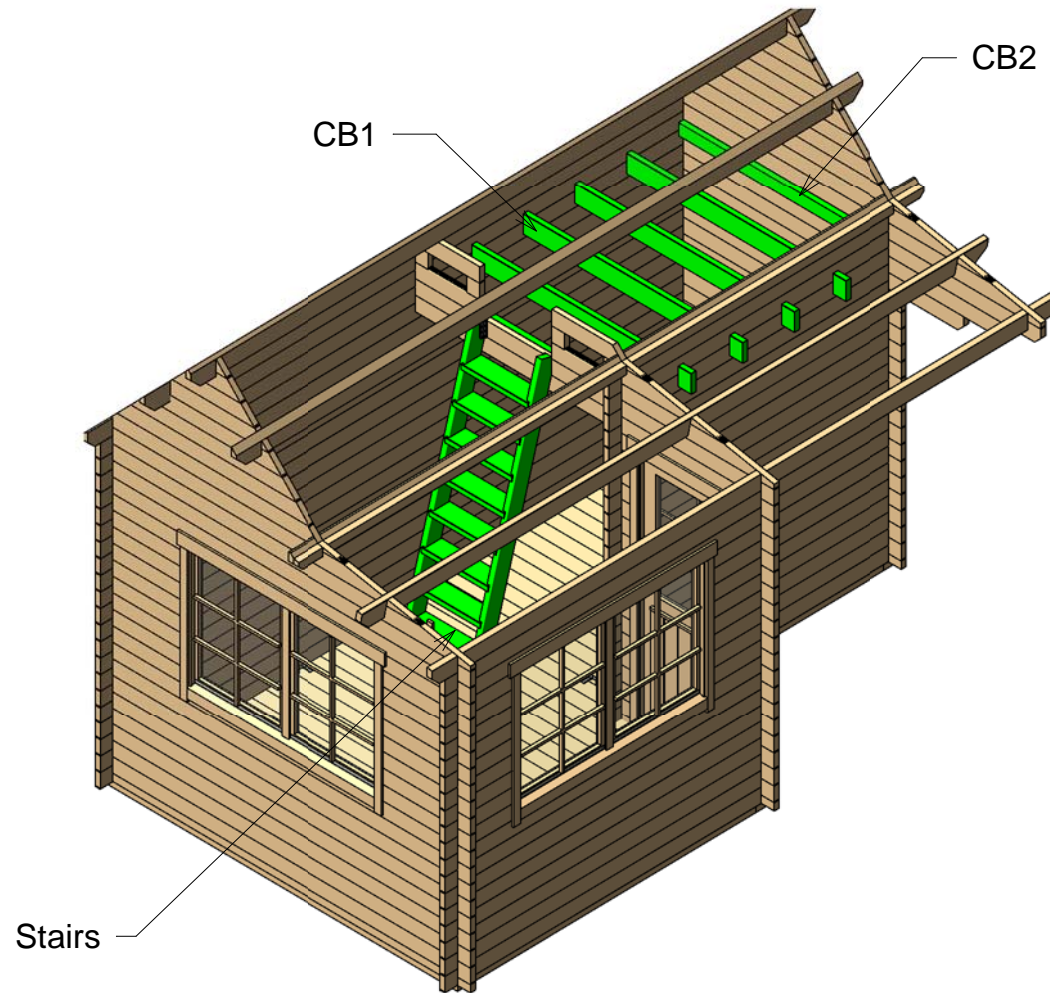
Second floor



Second floor				
Mark	Type	Profile	Count	Cut Length

CB1	Ceiling beam 40x143		4	1850
CB2	Ceiling beam 40x90		2	1567

# Laker Shed 40 (274x454)

Stair

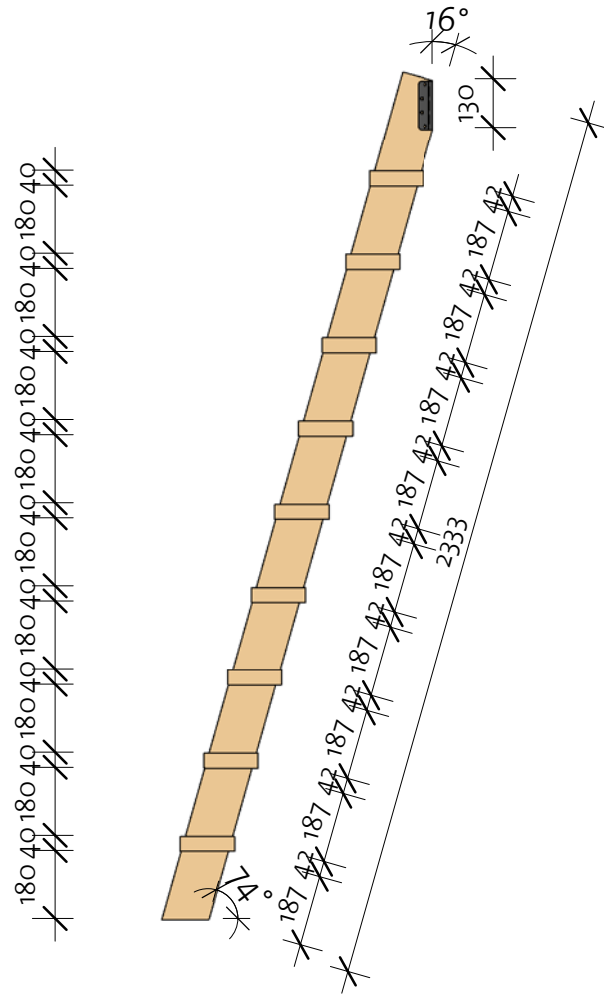
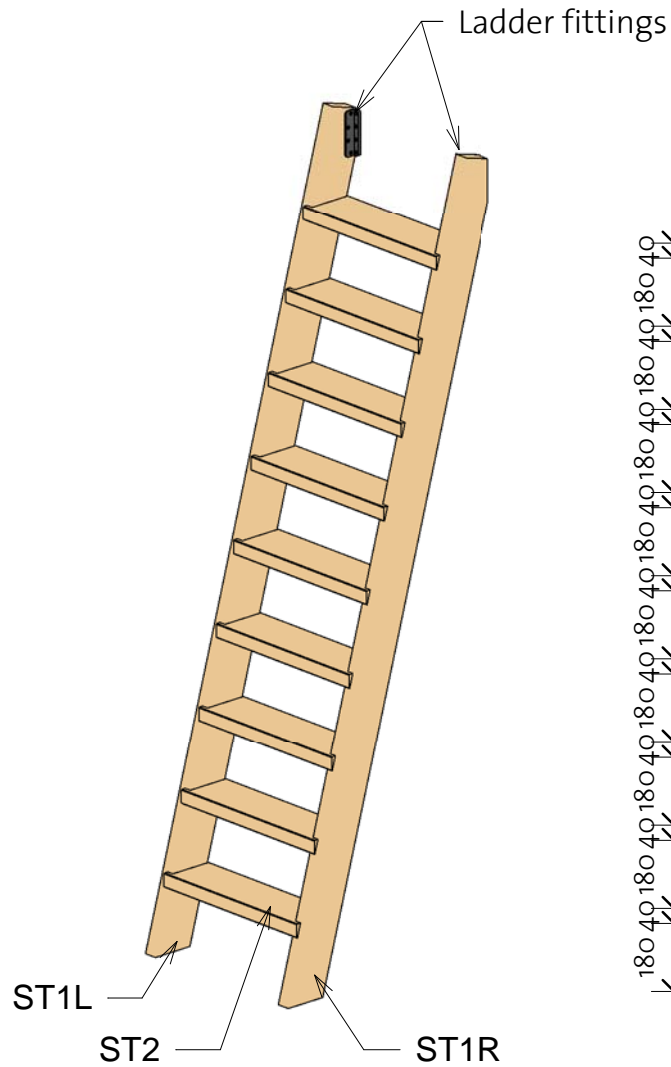

Stair				
Mark	Profile	Profile	Count	Cut Length
ST1R	Stair 40X120		1	2333
ST1L	Stair 40X120		1	2333
ST2	Stair 143X40		9	520

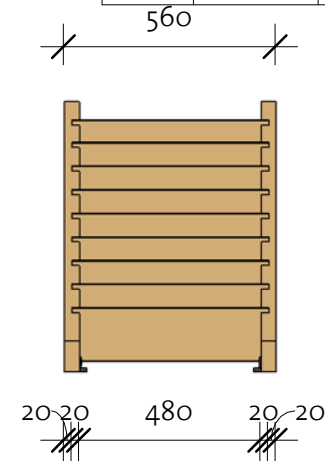

# Laker Shed 40 (274x454)

Roof 1

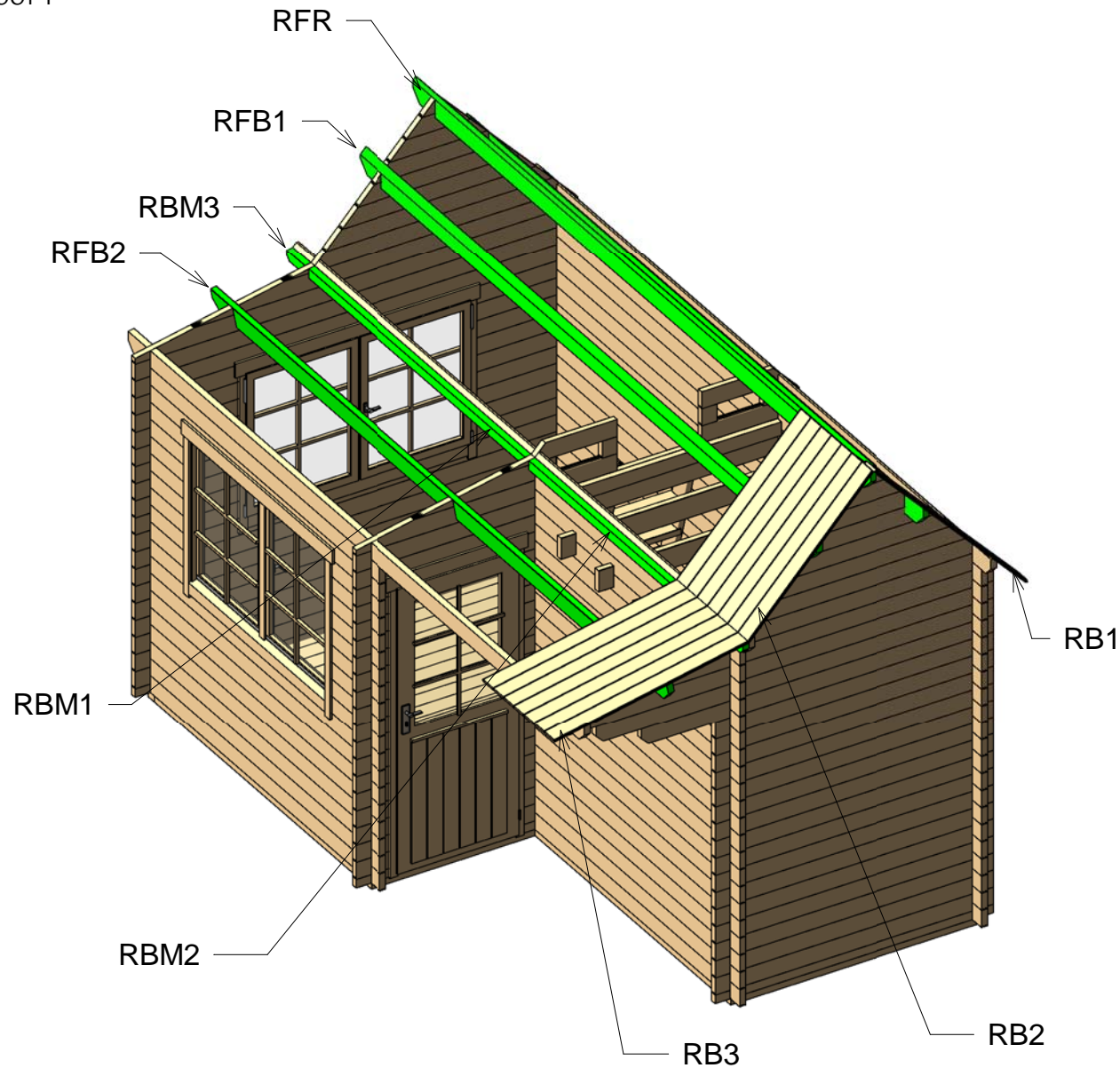

Roof				
Mark	Type	Profile	Count	Length
RB1	18x110		46	1492
RB2	18x110		46	1214
RB3	18x110		46	1308
RBM1	Roof beam 40x70		1	2350
RBM2	Roof beam 40x70		1	2070
RBM3	Roof beam 40x70		1	200
RBM4	Roof beam 40x70		1	200
RFB1	Beam 40x143		2	4940
RFB2	Beam 40x143		1	4940
RFR	Ridge 40x143		1	4940

# Laker Shed 40 (274x454)

Roof 2

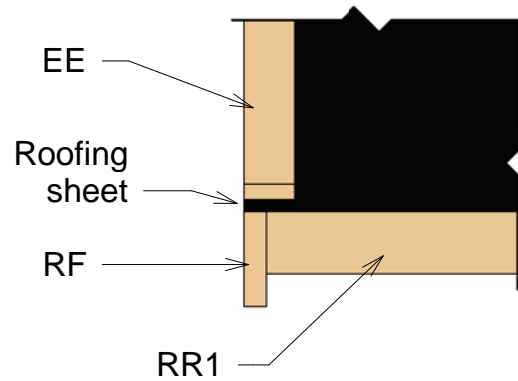
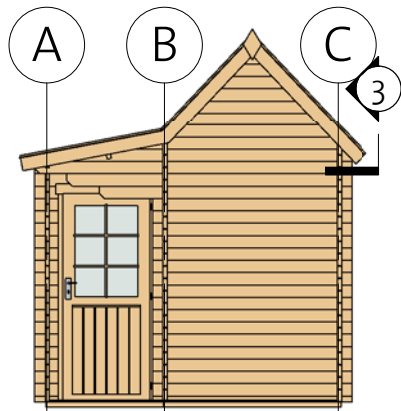
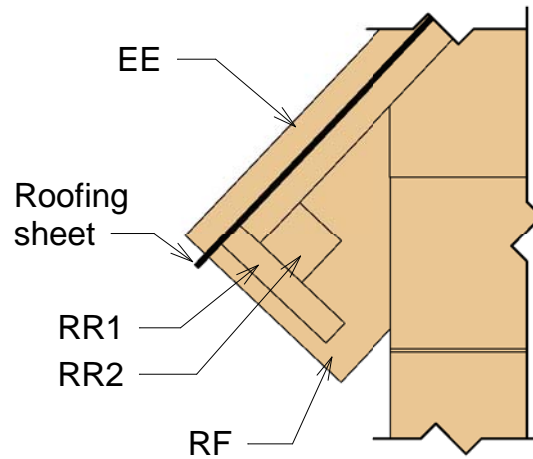
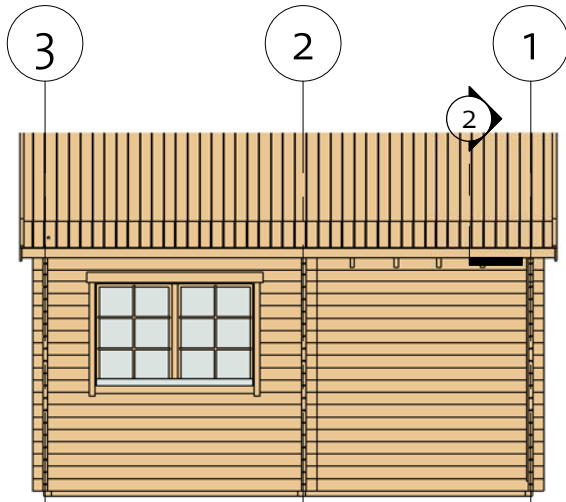

Fascia Schedule				
Mark	Type	Profile	Count	Length

EE1	Eave Edging 18x40		2	1522
EE2	Eave Edging 18x40		2	1217
EE3	Eave Edging 18x40		2	1334
RF1	Roof Fascia 18x120		2	1522
RF2	Roof Fascia 18x120		2	1253
RF3	Roof Fascia 18x120		2	1373
RR1	Roof reinforcement 18x95		2	4940
RR2	Roof reinforcement 38x38		2	4940

# Laker Shed 40 (274x454)

Extras

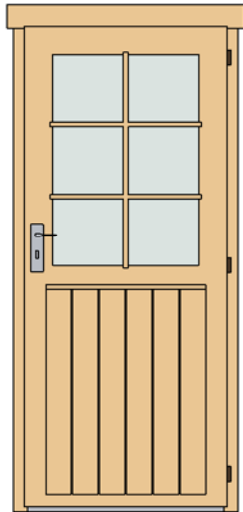

Door Schedule				
Model	Type	Width	Height	Count
CD4R	Classic door 4 right	840	1955	1
DCB6	Door Crossbar 6	--	--	1

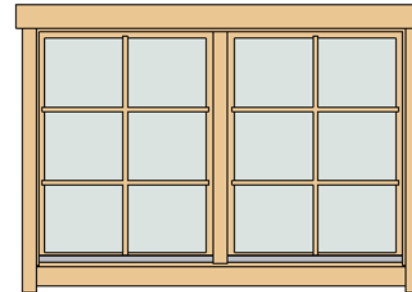

Window Schedule				
Mark	Type	Height	Width	Count
CDW1	Classic double window 1	990	1530	2
WCB6	Windows Crossbar 6	--	--	4

Fasteners/Extras		
Name	Type	Count

Hitblock	300-400 mm	
Ladder fittings		2
Bolts	M8x90	3
Bolts	M8x70	12
Screws	5,0 x 70	70
Nails	1,4 x 40	70
Screws	6,0 x 140	120
Screws	4,0 x 40	130
Screws	4,0 x 50	850



Type	Count
Romb	2





Type	Count	Length
Windboard 18x40	4	2640
Windboard 38x38	1	2640

91903251\_190522

# Laker Shed 40 (274x454)



## List of all items 1

Impregnated foundation beams				
Mark	Type	Profile	Count	Length
IFB1	IFB 70x45		1	1640
IFB2	IFB 70x45		5	4390
IFB3	IFB 70x45		4	2279
IFB4	IFB 70x45		1	1090
IFB5	IFB 70x45		1	2730

Second floor				
Mark	Type	Profile	Count	Cut Length
CB1	Ceiling beam 40x143		4	1850
CB2	Ceiling beam 40x90		2	1567

Stair				
Mark	Type	Profile	Count	Cut Length





Floor Schedule				
Mark	Type	Profile	Count	Length
FB1	FB 18x110		20	1565
FB2	FB 18x110		23	2655
FB3	FB 18x110		7	2110
FB4	FB 18x110		10	2065









ST1R	Stair 40x120		1	2333
ST1L	Stair 40x120		1	2333
ST2	Stair 143x40		9	520

BB1	BB 20x40		2	4800
BB2	BB 20x40		2	4300
BB3	BB 20x40		2	3000

# Laker Shed 40 (274x454)

## List of all items 2

Roof				
Mark	Type	Profile	Count	Length
RB1	18x110		46	1492
RB2	18x110		46	1214
RB3	18x110		46	1308
RBM1	Roof beam 40x70		1	2350
RBM2	Roof beam 40x70		1	2070
RBM3	Roof beam 40x70		1	200
RBM4	Roof beam 40x70		1	200
RFB1	Beam 40x143		2	4940
RFB2	Beam 40x143		1	4940
RFR	Ridge 40x143		1	4940

Fascia Schedule				
Mark	Type	Profile	Count	Length
EE1	Eave Edging 18x40		2	1522
EE2	Eave Edging 18x40		2	1217
EE3	Eave Edging 18x40		2	1334
RF1	Roof Fascia 18x120		2	1522
RF2	Roof Fascia 18x120		2	1253
RF3	Roof Fascia 18x120		2	1373
RR1	Roof reinforcement 18x95		2	4940
RR2	Roof reinforcement 38x38		2	4940



# Laker Shed 40 (274x454)

## List of all items 3

Wall 1			
Mark	Profile	Count	Cut Length

1BL-1	40x57	1	1850
1LG-1 *	40x114	1	216
1LG-2 *	40x114	1	431
1LG-3 *	40x114	1	647
1LG-4 *	40x114	1	863
1LG-5 *	40x114	1	1078
1LG-6 *	40x114	1	1294
1LG-7 *	40x114	1	1509
1LG-8 *	40x114	1	1894
1LG-9	40x114	1	2550
1LG-10	40x114	16	1850
1LG-11	40x114	1	2340
1LG-12	40x114	1	2640
1LG-13	40x114	1	2940
1LG-14	40x114	1	2940



Wall 2			
Mark	Profile	Count	Cut Length

2BL-1 *	40x57	2	240
2LG-1 *	40x114	1	940
2LG-2 *	40x114	34	240
2LG-3 *	40x114	1	1735
2LG-4 *	40x114	1	2940
2LG-5 *	40x114	1	2940
2LG-6 *	40x114	1	645
2LG-7 *	40x114	2	100
2LG-8	40x114	1	240
2LG-9	40x114	1	751
2LG-10	40x114	1	582

\* Gable -  
delivered premounted

Wall 3			
Mark	Profile	Count	Cut Length

3BL-1	40x57	1	2940
3LG-1	40x114	1	216
3LG-2	40x114	1	431
3LG-3	40x114	1	647
3LG-4	40x114	1	863
3LG-5	40x114	1	1078
3LG-6	40x114	1	1294
3LG-7	40x114	1	1509
3LG-8	40x114	1	1894
3LG-9	40x114	1	2550
3LG-10	40x114	18	700
3LG-11	40x114	1	2940
3LG-12	40x114	10	2940

Log Profiles 1	
Profile	Profile
40x57	
40x114	
40x114	

# Laker Shed 40 (274x454)

## List of all items 4

Wall C			
Mark	Profile	Count	Cut Length

CLG-1	40X114	17	4740
CLG-2	40X114	1	4740
CLG-3	40X114	1	4740
CLG-4	40X114	1	4740
CLG-5	40X114	1	4740
CTL-1	40X123	1	4940



Wall B			
Mark	Profile	Count	Cut Length

BLG-1	40X114	19	2350
BLG-2	40X114	1	2350
BLG-3	40X114	1	2350
BTL-1	40X123	1	4940

Wall A			
Mark	Profile	Count	Cut Length

ALG-1	40X114	16	545
ALG-2	40X114	9	2630
ALG-3	40X114	1	2630
ALG-4	40X114	1	2630
ATL-1	40X123	1	4940

Log profiles 2	
Profile	Profile

40X123	
40X114	
40X114	
40X123	