

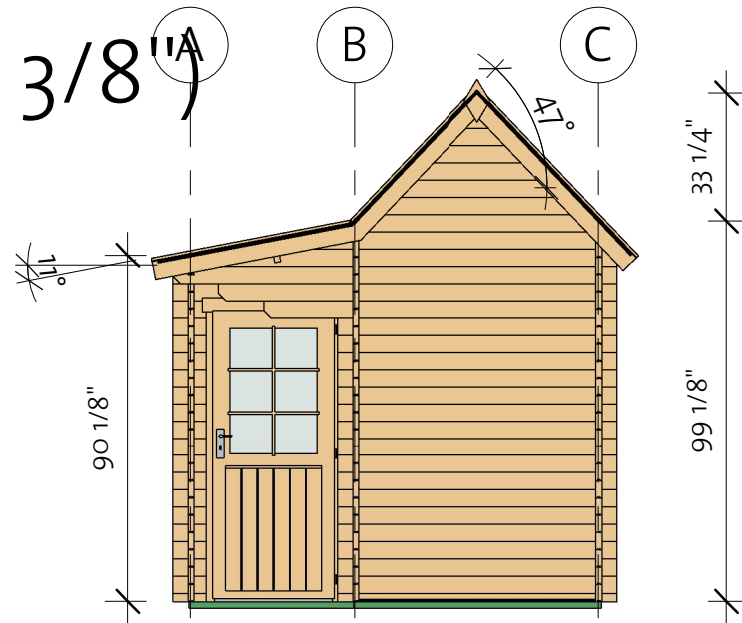

Laker Shed B 40 (107 7/8" x 176 3/8")

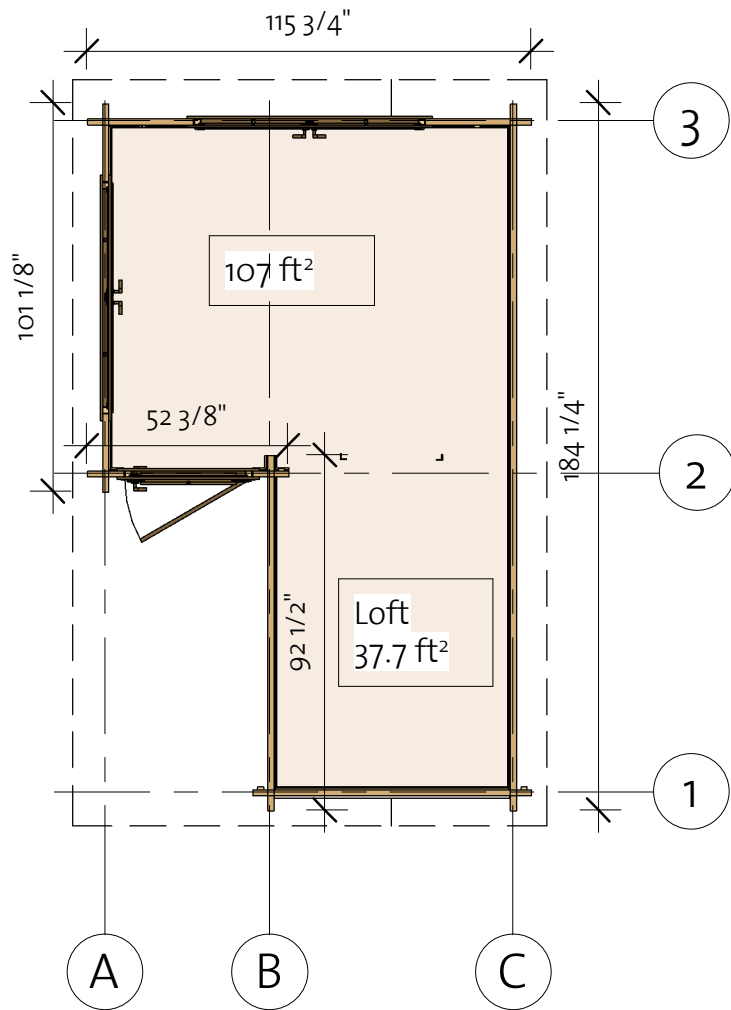
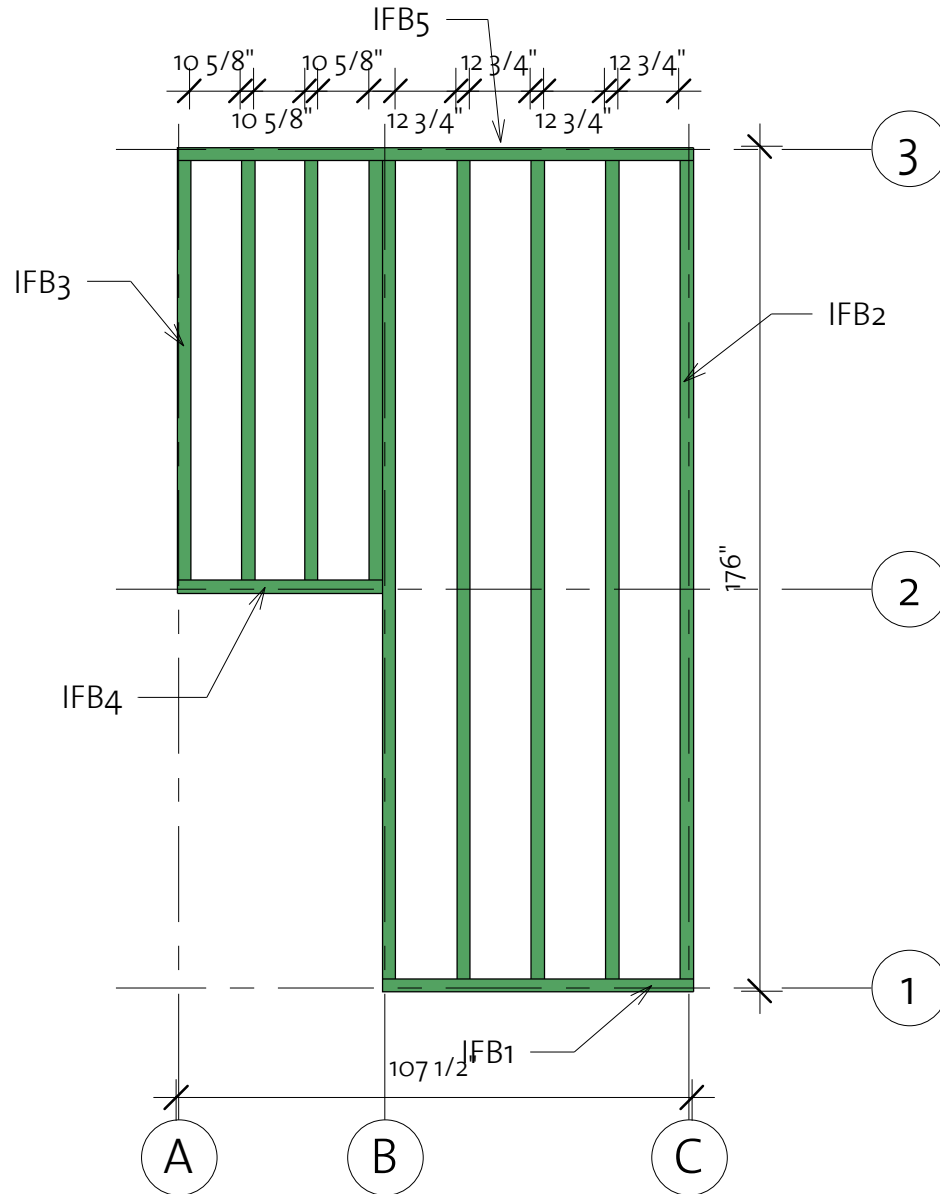

Laker Shed B 40 (107 7/8" x 176 3/8")

Foundation



Impregnated foundation beams				
Mark	Type	Profile	Count	Length
IFB1	IFB 70x40		1	64 5/8"
IFB2	IFB 70x40		5	170 1/2"
IFB3	IFB 70x40		4	87 3/8"
IFB4	IFB 70x40		1	42 7/8"
IFB5	IFB 70x40		1	107 1/2"



Laker Shed B 40 (107 7/8" x 176 3/8")

Floor Plan

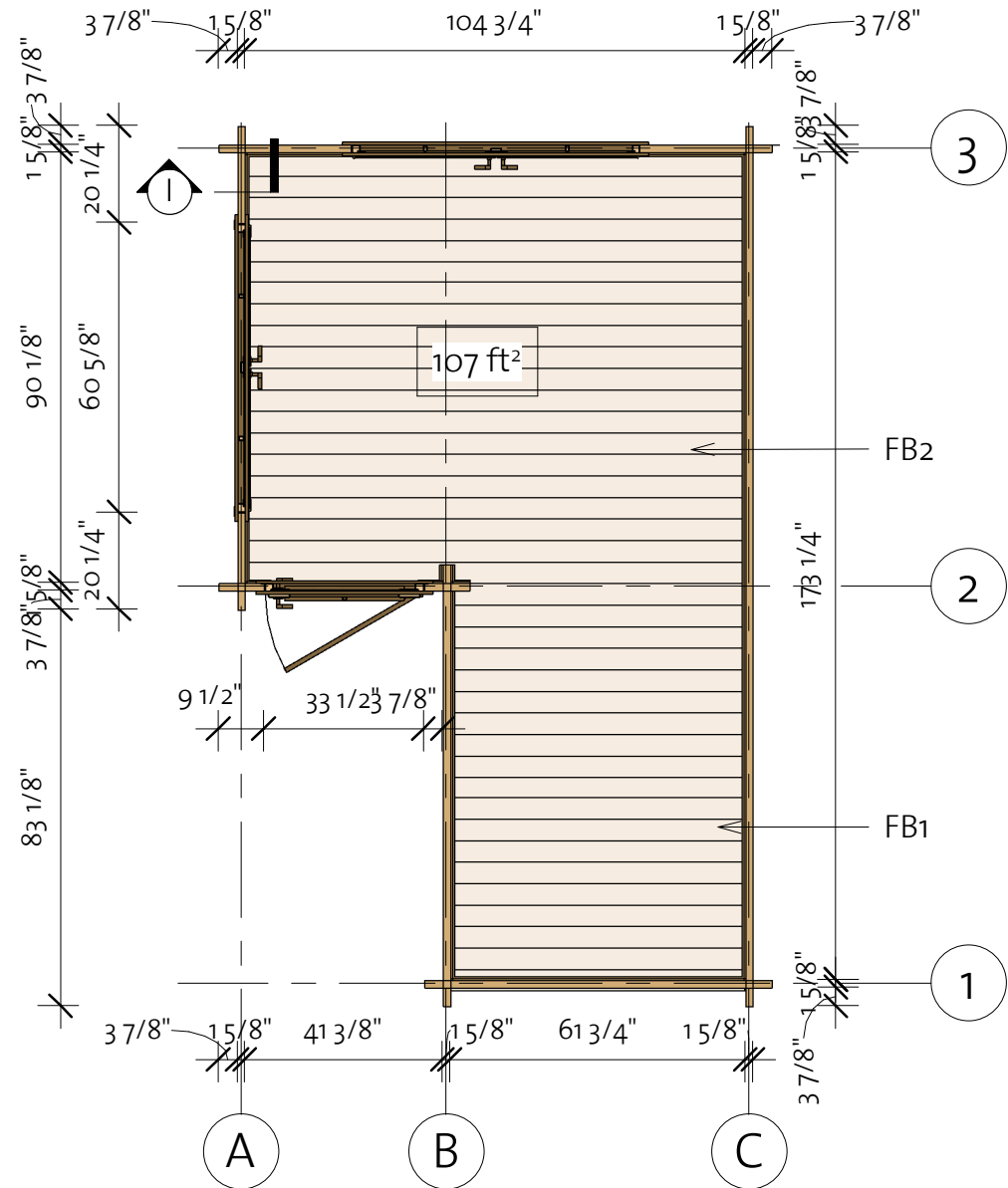
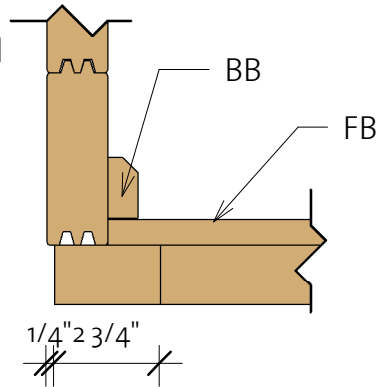
① Baseboard



Floor Schedule

Mark	Type	Profile	Count	Length
FB1	FB 17x114		20	61 5/8"
FB2	FB 17x114		21	104 1/2"
FB3	FB 17x114		15	83 1/8"
BB1	BB 20x40		2	189"
BB2	BB 20x40		2	169 5/16"
BB3	BB 20x40		2	118 1/8"

Laker Shed B 40 (107 7/8" x 176 3/8")

Wall 1

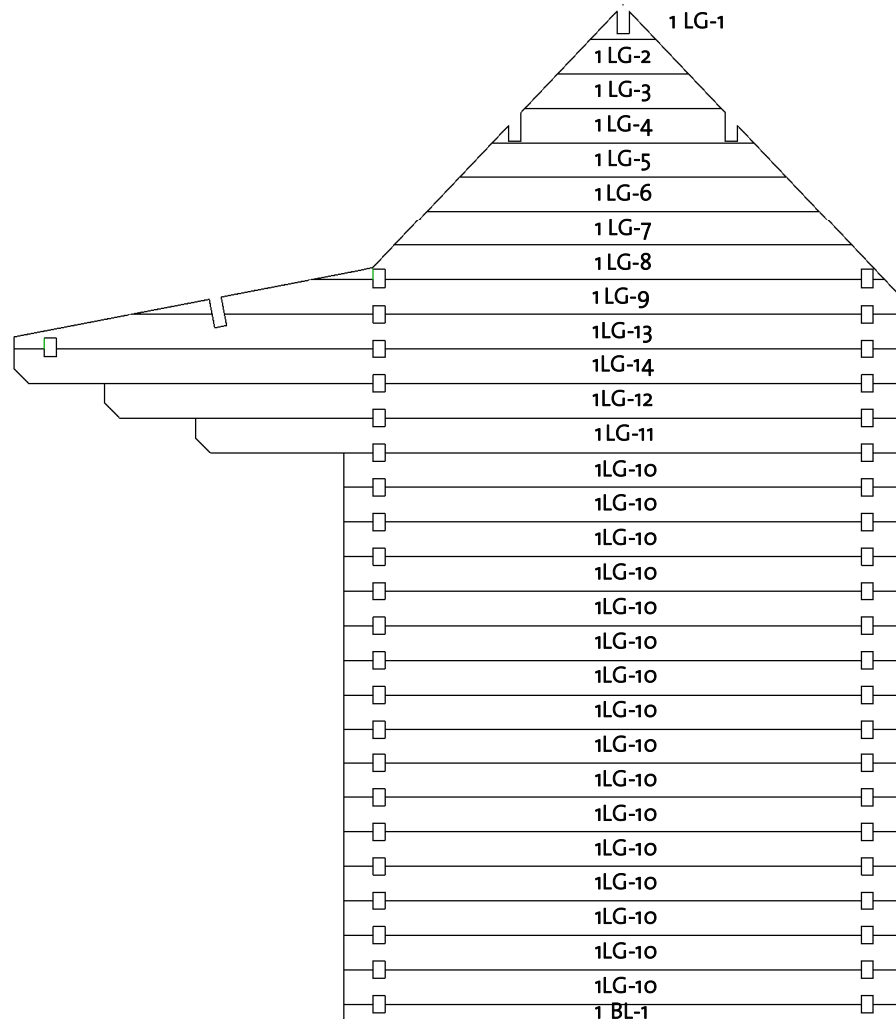
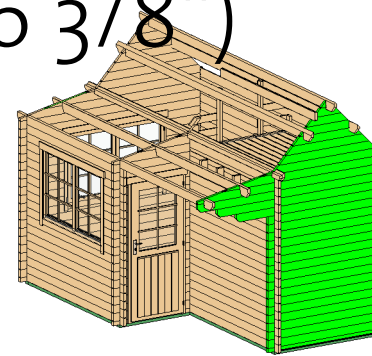

Wall 1			
Mark	Profile	Count	Cut Length

1BL-1	40X57	1	72 7/8"
1LG-1 *	40X114	1	8 1/2"
1LG-2 *	40X114	1	17"
1LG-3 *	40X114	1	25 1/2"
1LG-4 *	40X114	1	34"
1LG-5 *	40X114	1	42 1/2"
1LG-6 *	40X114	1	50 7/8"
1LG-7 *	40X114	1	59 3/8"
1LG-8 *	40X114	1	74 1/2"
1LG-9 *	40X114	1	100 3/8"
1LG-10	40X114	16	72 7/8"
1LG-11	40X114	1	92 1/8"
1LG-12	40X114	1	103 7/8"
1LG-13 *	40X114	1	115 3/4"
1LG-14	40X114	1	115 3/4"

* Gable - delivered premounted

Log Profile Wall 1	
Profile	Profile

Log Profile Wall 1	
Profile	Profile

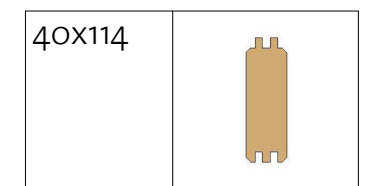
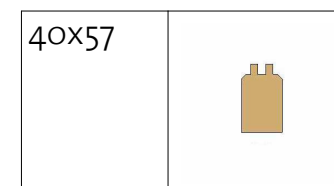

Laker Shed B 40 (107 7/8" x 176 3/8")

Wall 2

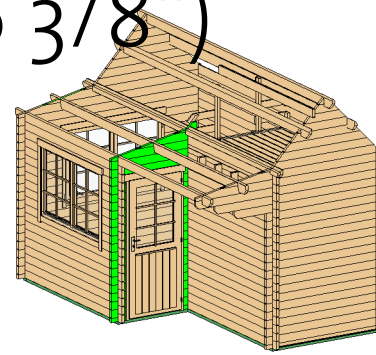

Wall 2			
Mark	Profile	Count	Cut Length

2BL-1	40X57	2	9 1/2"
2LG-1 *	40X114	1	37"
2LG-2	40X114	34	9 1/2"
2LG-3 *	40X114	1	52 3/8"
2LG-4	40X114	1	115 3/4"
2LG-5	40X114	1	115 3/4"
2LG-6 *	40X114	1	13 5/8"

* Gable - delivered premounted

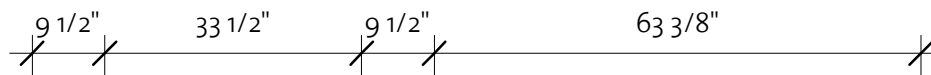
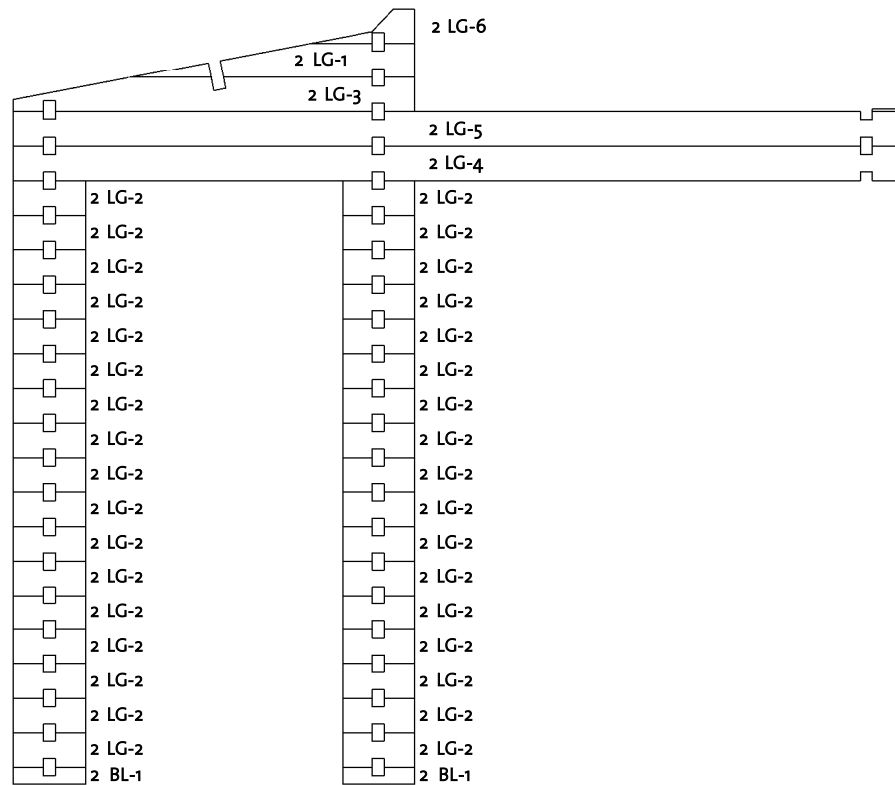

Log Profile Wall 2	
Profile	Profile

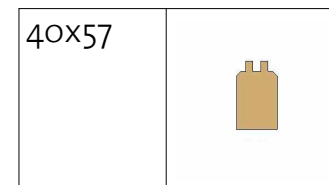

Log Profile Wall 2	
Profile	Profile

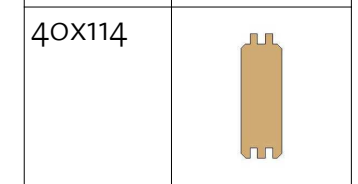
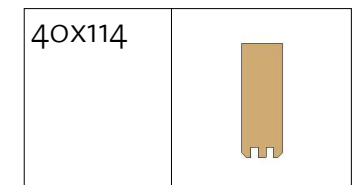

Laker Shed B 40 (107 7/8" x 176 3/8")

Wall 3

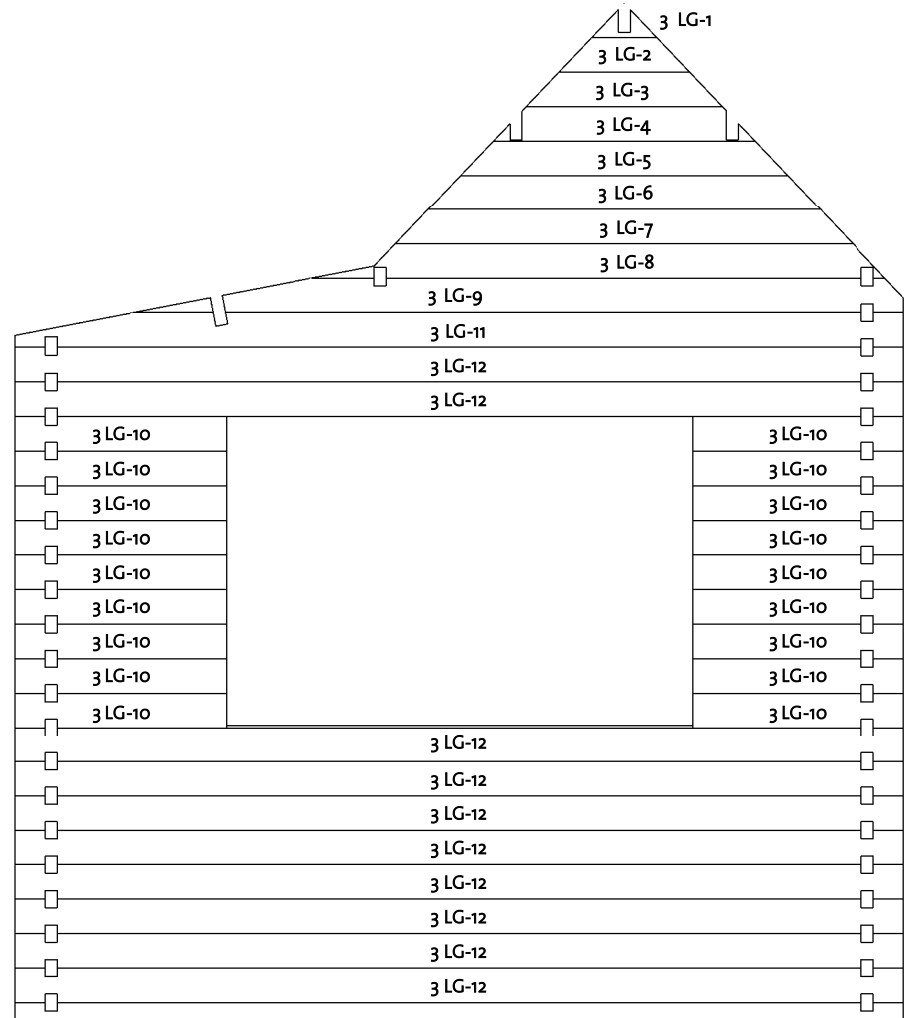
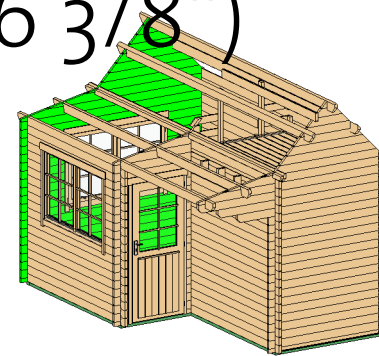

Wall 3			
Mark	Profile	Count	Cut Length

3BL-1	40X57	1	115 3/4"
3LG-1*	40X114	1	8 1/2"
3LG-2*	40X114	1	17"
3LG-3*	40X114	1	25 1/2"
3LG-4*	40X114	1	34"
3LG-5*	40X114	1	42 1/2"
3LG-6*	40X114	1	50 7/8"
3LG-7*	40X114	1	59 3/8"
3LG-8*	40X114	1	74 1/2"
3LG-9*	40X114	1	100 3/8"
3LG-10	40X114	18	27 1/2"
3LG-11*	40X114	1	115 3/4"
3LG-12	40X114	10	115 3/4"

* Gable - delivered premounted

Log Profile Wall 3	
Profile	Profile

Log Profile Wall 3	
Profile	Profile

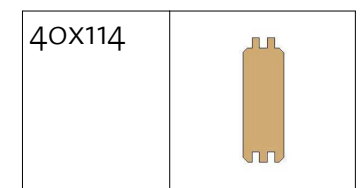
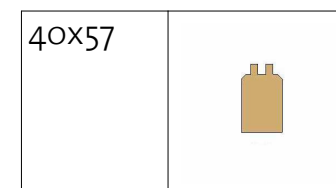

Laker Shed B 40 (107 7/8" x 176 3/8")

Wall A

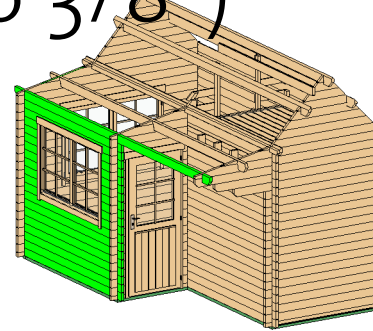

Wall A			
Mark	Profile	Count	Cut Length

ALG-1	40X114	16	20 1/4"
ALG-2	40X114	9	101 1/8"
ALG-3	40X114	1	101 1/8"
ALG-4	40X114	1	101 1/8"
ATL-1	40X123	1	192 1/8"

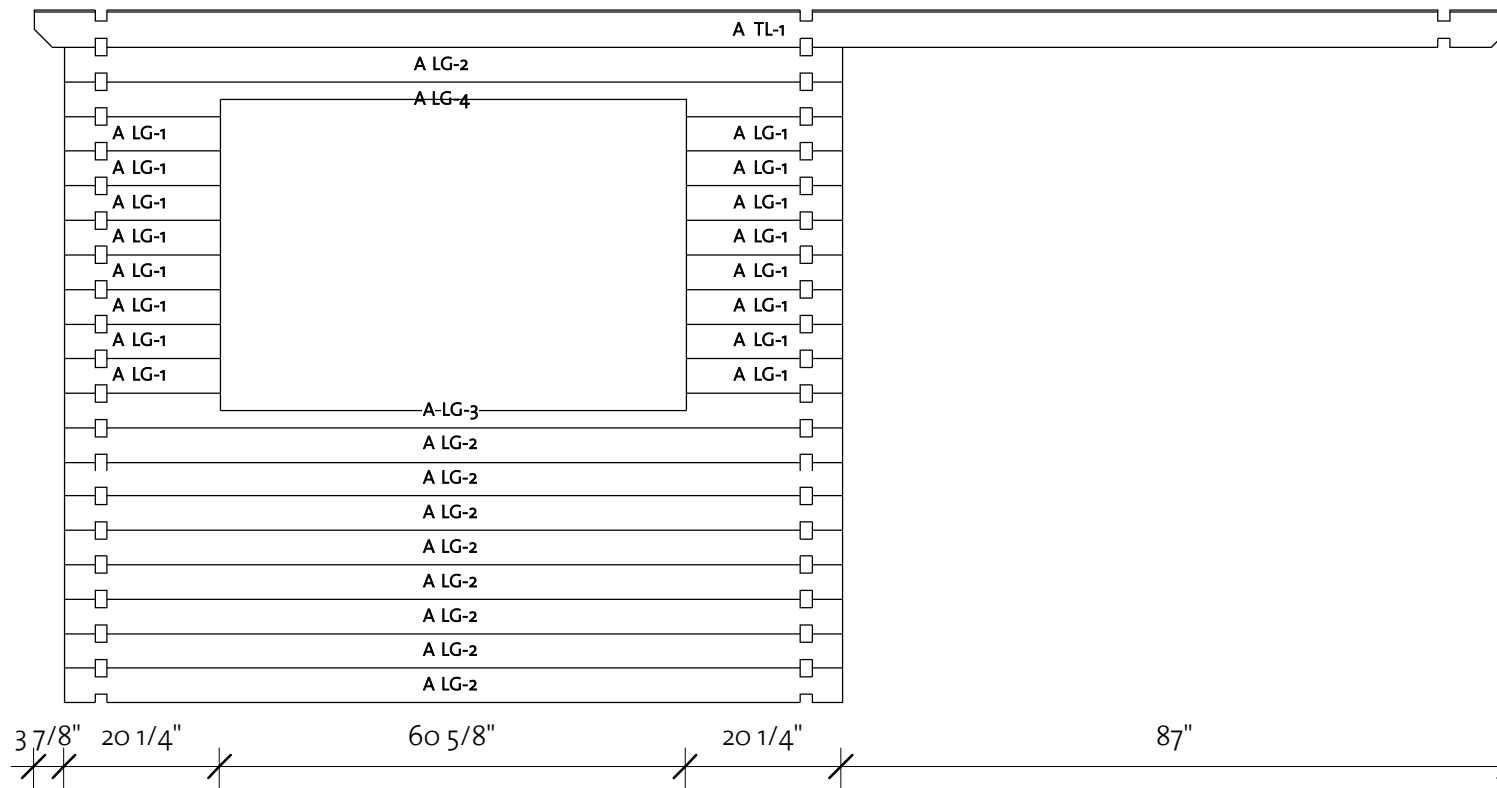

Log Profile Wall A	
Profile	Profile

40X114	
40X123	

Laker Shed B 40 (107 7/8" x 176 3/8")

Wall B

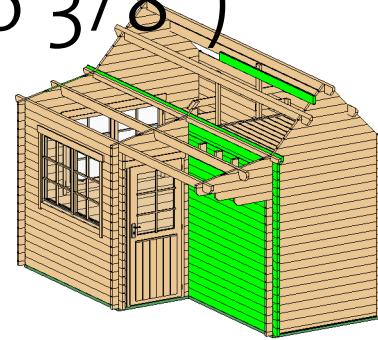

Wall B			
Mark	Profile	Count	Cut Length

BLG-1	4OX114	19	92 1/2"
BLG-2	4OX114	1	92 1/2"
BLG-3	4OX114	1	92 1/2"
BTL-1	4OX123	1	192 1/8"

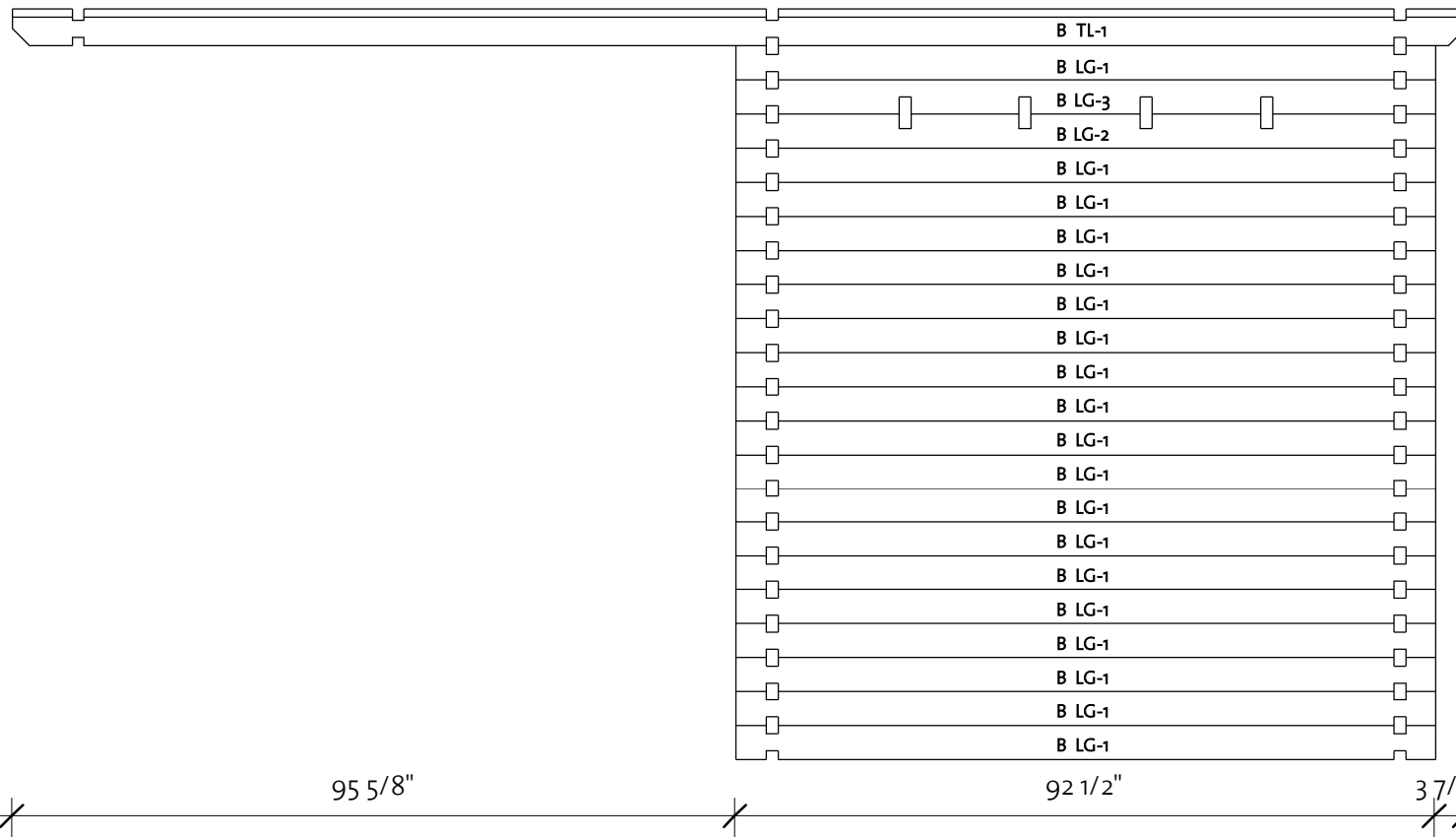

Log Profile Wall B	
Profile	Profile

4OX114	
4OX123	

Laker Shed B 40 (107 7/8" x 176 3/8")

Wall C

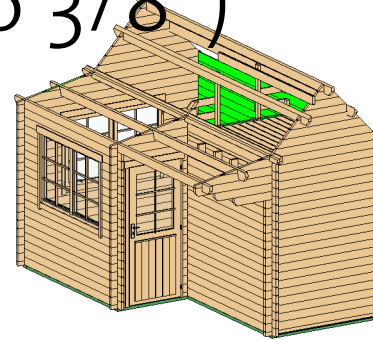

Wall C			
Mark	Profile	Count	Cut Length

CLG-1	40X114	18	184 1/4"
CLG-2	40X114	1	184 1/4"
CLG-3	40X114	1	184 1/4"
CLG-4	40X114	1	184 1/4"
CTL-1	40X123	1	192 1/8"

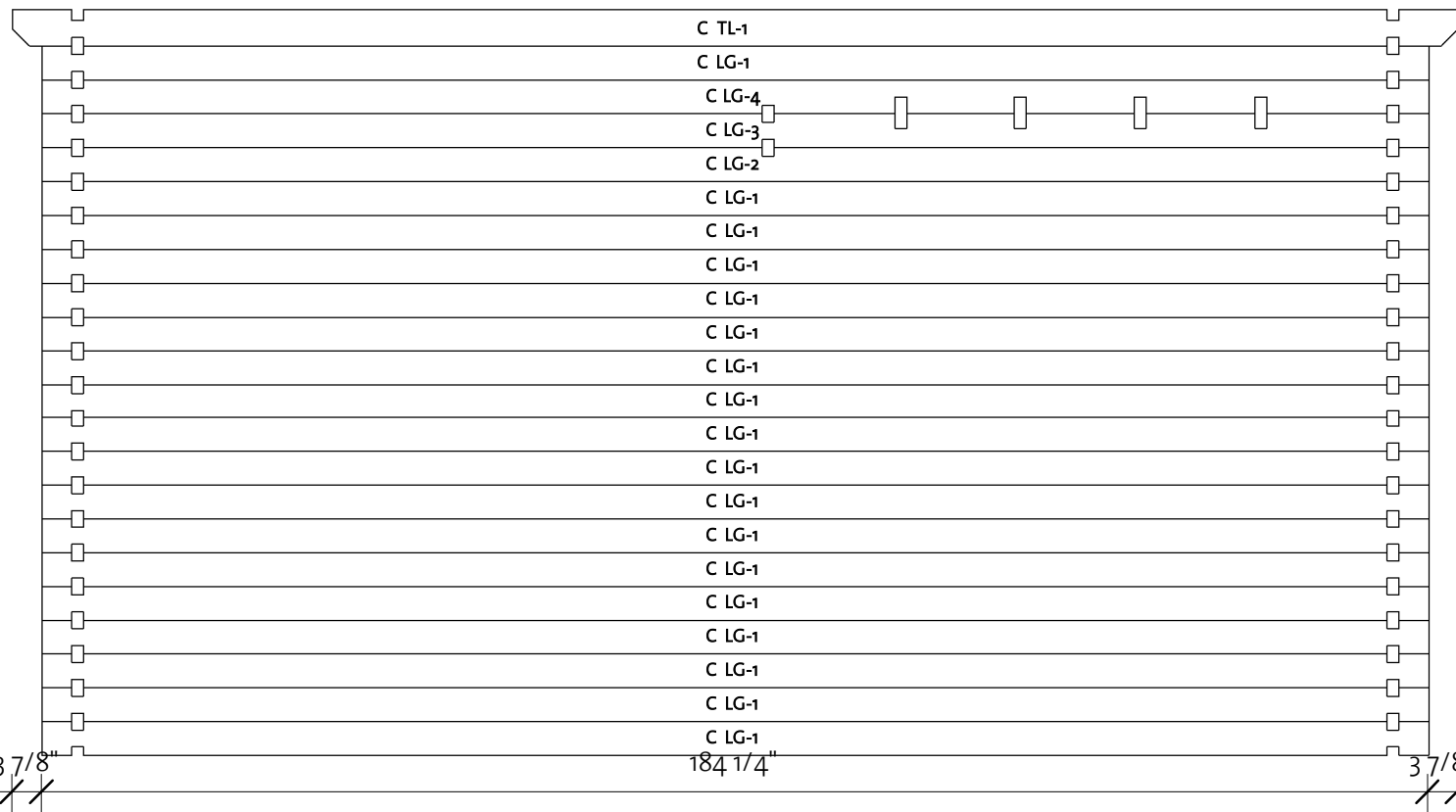

Log Profile Wall C	
Profile	Profile

40X114	
40X123	

Laker Shed B 40 (107 7/8" x 176 3/8")

Second floor

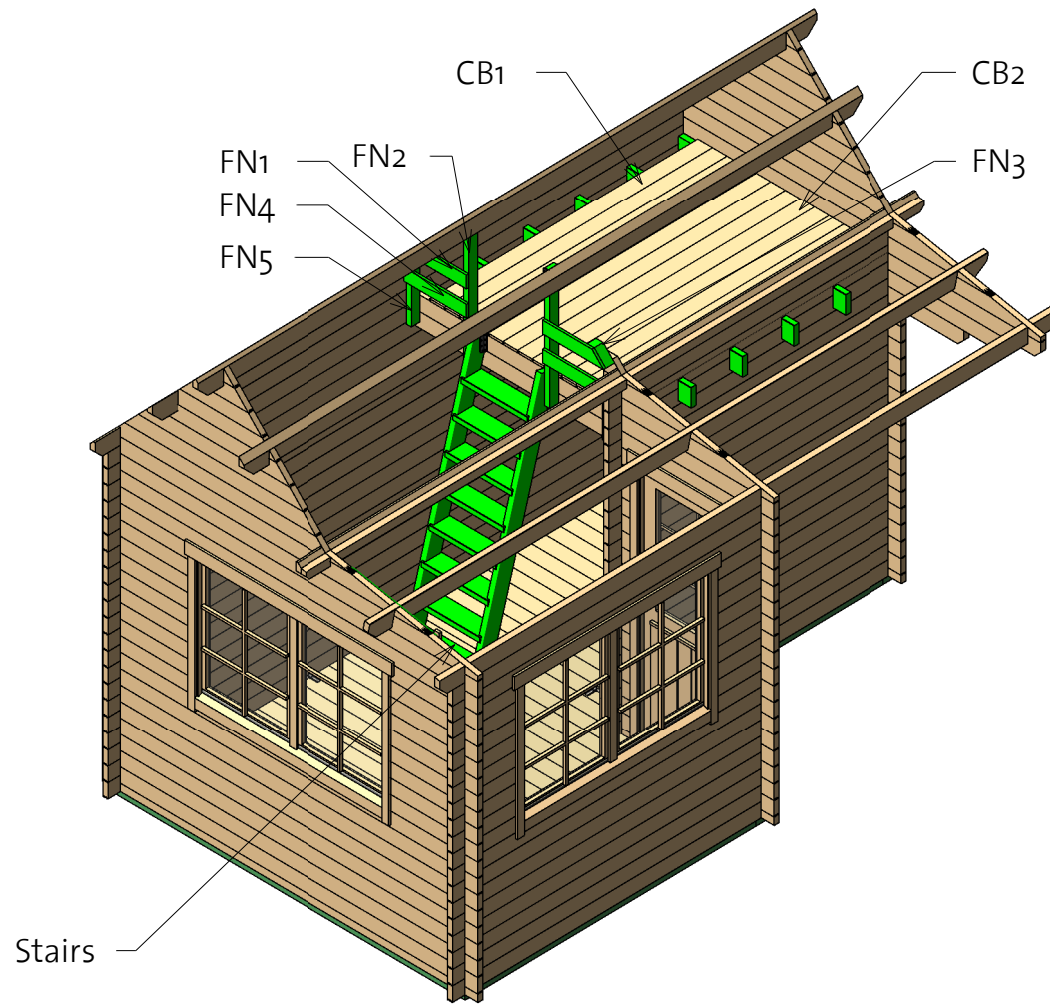

Second floor				
Mark	Type	Profile	Count	Cut Length

CB2	Ceiling beam 40x90		2	61 3/4"
CB1	Ceiling beam 40x143		4	72 7/8"
FN1	Fence 18x95		2	18 3/4"
FN4	Fence 18x95		2	19 1/4"
FN2	Fence 40x70		2	37 3/8"
FN3	Fence 40x70		2	6 5/8"
FN5	Fence 40x70		2	15 3/4"

Laker Shed B 40 (107 7/8" x 176 3/8")

Fence

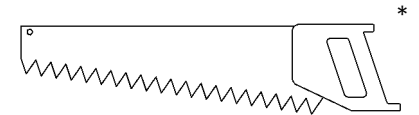
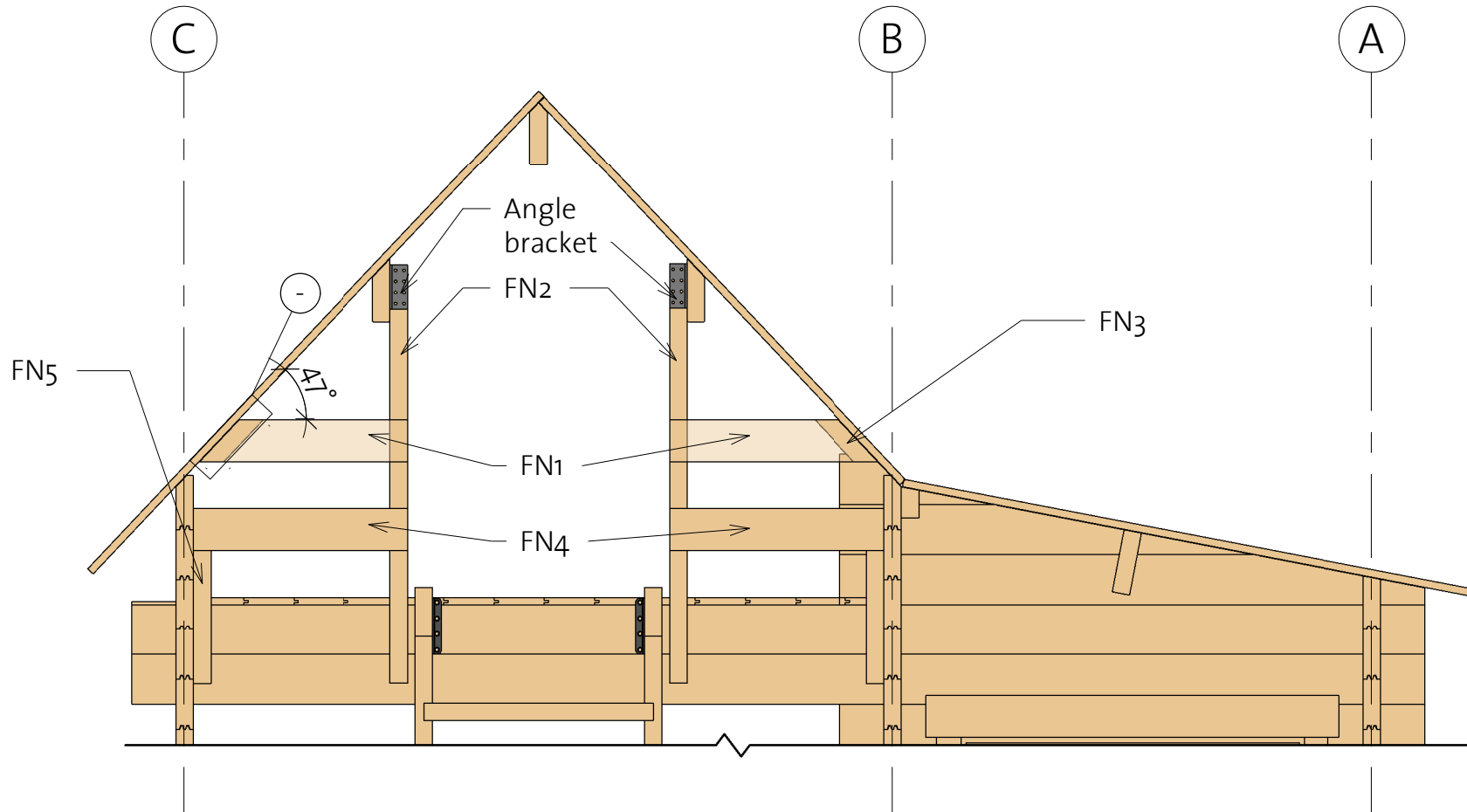

Laker Shed B 40 (107 7/8" x 176 3/8")

Stair

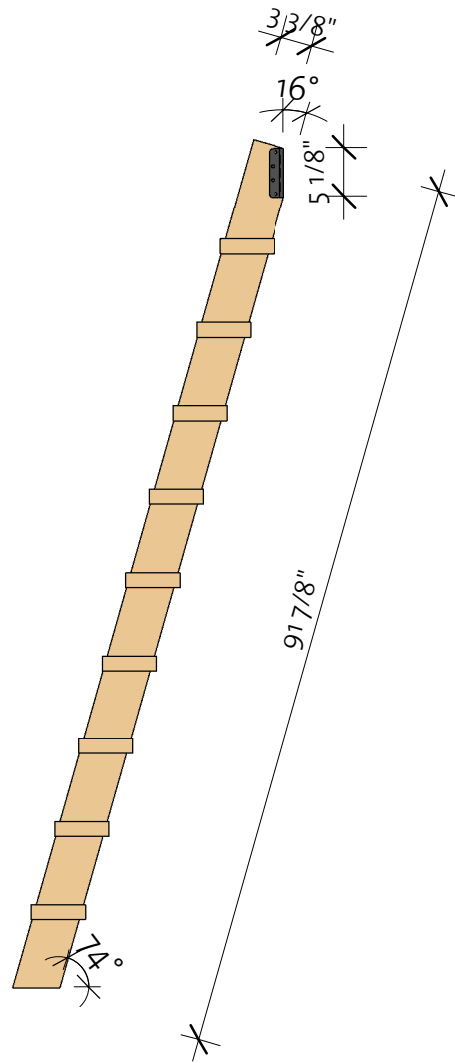
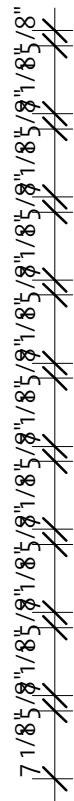
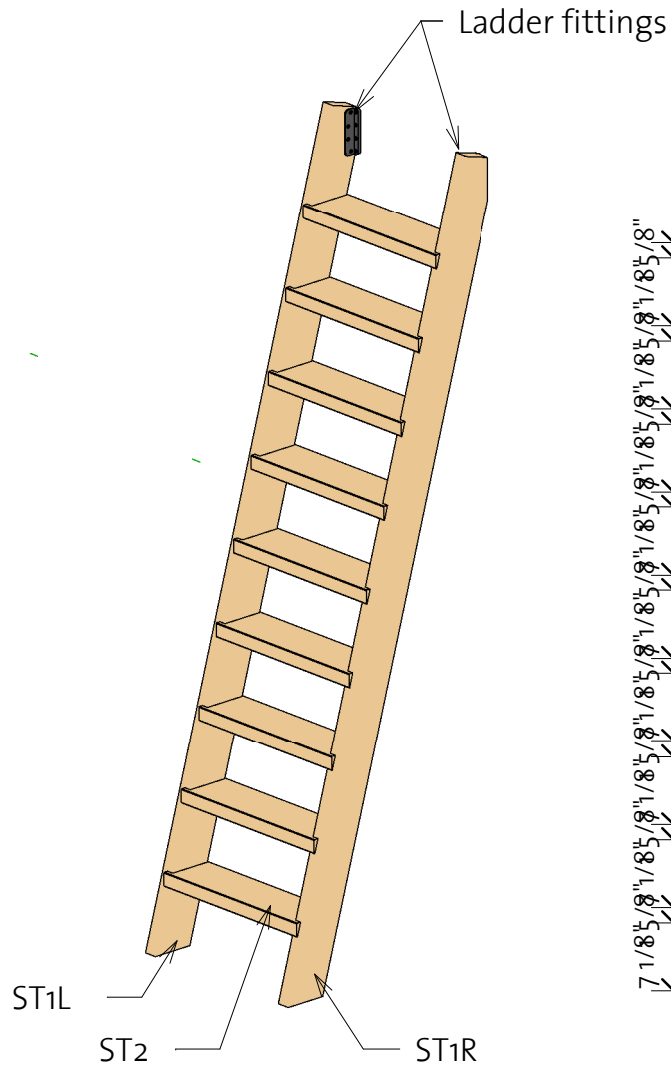

Stair				
Mark	Profile	Profile	Count	Cut Length
ST1R	Stair 40X120		1	91 7/8"
ST1L	Stair 40X120		1	91 7/8"
ST2	Stair 143X40		9	20 1/2"

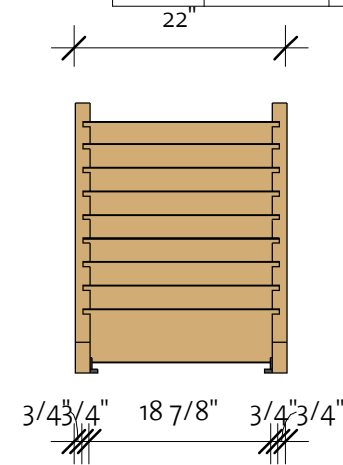

Laker Shed B 40 (107 7/8" x 176 3/8")

Roof 1

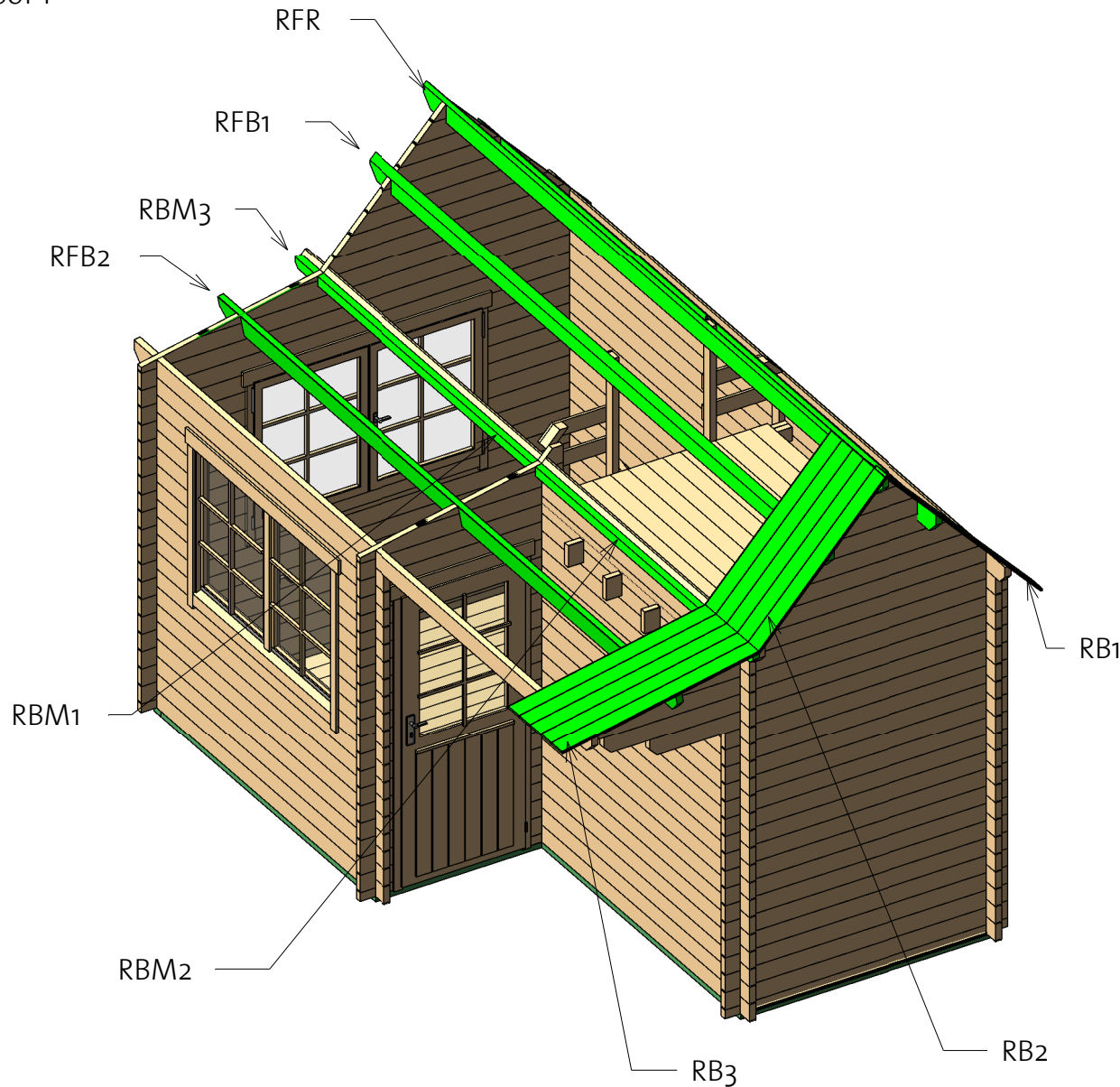

		Roof			
Mark	Type	Profile	Count	Cut Length	
RB1	17x114		44	58 3/4"	
RB2	17x114		44	47"	
RB3	17x114		44	51 1/2"	
RBM1	Roof beam 40x70		1	90 1/8"	
RBM2	Roof beam 40x70		1	81 1/2"	
RBM3	Roof beam 40x70		1	7 7/8"	
RBM4	Roof beam 40x70		1	7 7/8"	
RFB1	Beam 40x143		2	192 1/8"	
RFB2	Beam 40x143		1	192 1/8"	
RFR	Ridge 40x143		1	192 1/8"	

Laker Shed B 40 (107 7/8" x 176 3/8")

Roof 2

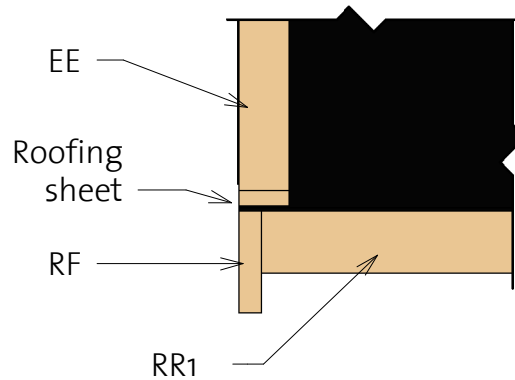
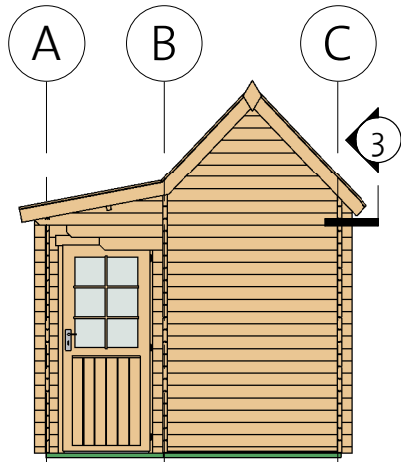
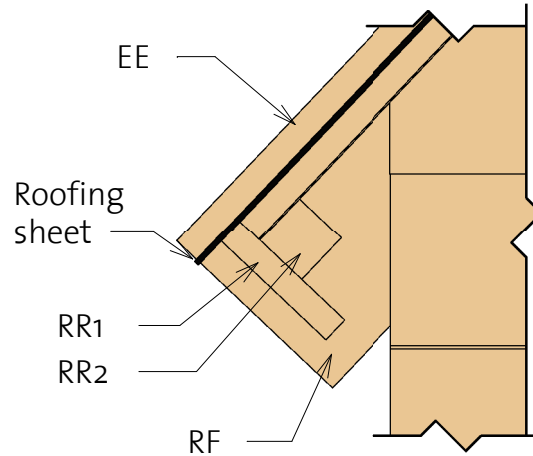
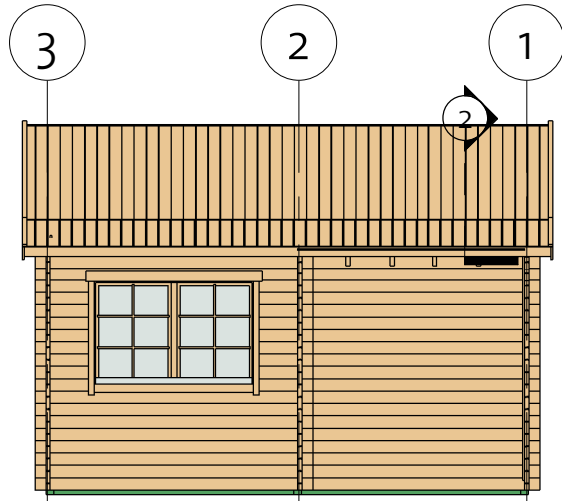

Fascia Schedule

Mark	Type	Profile	Count	Length
EE1	Eave Edging 18x40		2	60 1/4"
EE2	Eave Edging 18x40		2	48 11/16"
EE3	Eave Edging 18x40		2	52 13/16"
RF1	Roof Fascia 18x120		2	60 1/4"
RF2	Roof Fascia 18x120		2	49 5/16"
RF3	Roof Fascia 18x120		2	54 3/8"
RR1	Roof reinforcement 18x95		2	192 1/8"
RR2	Roof reinforcement 38x38		2	192 1/8"

Laker Shed B 40 (107 7/8" x 176 3/8")

Extras



CD4R	Classic door 4 right	33 1/8"	77"	1
------	----------------------	---------	-----	---

DCB6	Door Crossbar 6	--	--	0"
------	-----------------	----	----	----

Window Schedule				
Mark	Type	Height	Width	Count

CDW1	Classic double window 1	39"	60 1/4"	2
------	-------------------------	-----	---------	---

WCB6	Windows Crossbar 6	--	--	4
------	--------------------	----	----	---

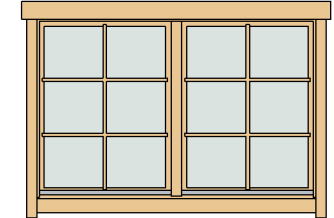

Fasteners/Extras		
Name	Type	Count

Screws	5,0 x 70	70
Hitblock	300-400 mm	
Nails	1,4 x 40	70
Screws	6,0 x 140	120
Screws	4,0 x 40	1000
Bolts	M8x70	15
Ladder fittings		2
Angle bracket		2
Screws	5,0 x 40	12



Type	Count
------	-------

Romb	2
------	---

Type	Count	Length
------	-------	--------



Windboard 18x40	5	103 15/16"
-----------------	---	------------









Laker Shed B 40 (107 7/8"x176 3/8")

List of all items 1

Impregnated foundation beams				
Mark	Type	Profile	Count	Length
IFB1	IFB 70x40		1	64 5/8"
IFB2	IFB 70x40		5	170 1/2"
IFB3	IFB 70x40		4	87 3/8"
IFB4	IFB 70x40		1	42 7/8"
IFB5	IFB 70x40		1	107 1/2"



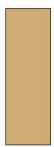
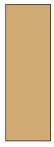









Floor Schedule				
Mark	Type	Profile	Count	Length
FB1	FB 17x114		20	61 5/8"
FB2	FB 17x114		21	104 1/2"
FB3	FB 17x114		15	83 1/8"
BB1	BB 20x40		2	189"
BB2	BB 20x40		2	169 5/16"
BB3	BB 20x40		2	118 1/8"

Second floor				
Mark	Type	Profile	Count	Cut Length
CB2	Ceiling beam 40x90		2	61 3/4"
CB1	Ceiling beam 40x143		4	72 7/8"
FN1	Fence 18x95		2	18 3/4"
FN4	Fence 18x95		2	19 1/4"
FN2	Fence 40x70		2	37 3/8"
FN3	Fence 40x70		2	6 5/8"
FN5	Fence 40x70		2	15 3/4"

Stair				
Mark	Type	Profile	Count	Cut Length
ST1R	Stair 40x120		1	91 7/8"
ST1L	Stair 40x120		1	91 7/8"
ST2	Stair 143x40		9	20 1/2"

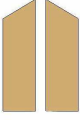
Laker Shed B 40 (107 7/8"x176 3/8")

List of all items 2

Roof					Fascia Schedule				
Mark	Type	Profile	Count	Cut Length	Mark	Type	Profile	Count	Length
RB1	17x114		44	58 3/4"	EE1	Eave Edging 18x40		2	60 1/4"
RB2	17x114		44	47"	EE2	Eave Edging 18x40		2	48 11/16"
RB3	17x114		44	51 1/2"	EE3	Eave Edging 18x40		2	52 13/16"
RBM1	Roof beam 40x70		1	90 1/8"	RF1	Roof Fascia 18x120		2	60 1/4"
RBM2	Roof beam 40x70		1	81 1/2"	RF2	Roof Fascia 18x120		2	49 5/16"
RBM3	Roof beam 40x70		1	77/8"	RF3	Roof Fascia 18x120		2	54 3/8"
RBM4	Roof beam 40x70		1	77/8"	RR1	Roof reinforcement 18x95		2	192 1/8"
RFB1	Beam 40x143		2	192 1/8"	RR2	Roof reinforcement 38x38		2	192 1/8"
RFB2	Beam 40x143		1	192 1/8"					
RFR	Ridge 40x143		1	192 1/8"					

Laker Shed B 40 (107 7/8"x176 3/8")

List of all items 3

Wall 1			
Mark	Profile	Count	Cut Length

1BL-1	40x57	1	72 7/8"
1LG-1 *	40x114	1	8 1/2"
1LG-2 *	40x114	1	17"
1LG-3 *	40x114	1	25 1/2"
1LG-4 *	40x114	1	34"
1LG-5 *	40x114	1	42 1/2"
1LG-6 *	40x114	1	50 7/8"
1LG-7 *	40x114	1	59 3/8"
1LG-8 *	40x114	1	74 1/2"
1LG-9 *	40x114	1	100 3/8"
1LG-10	40x114	16	72 7/8"
1LG-11	40x114	1	92 1/8"
1LG-12	40x114	1	103 7/8"
1LG-13 *	40x114	1	115 3/4"
1LG-14	40x114	1	115 3/4"

* Gable - delivered premounted

Wall 3			
Mark	Profile	Count	Cut Length

3BL-1	40x57	1	115 3/4"
3LG-1 *	40x114	1	8 1/2"
3LG-2 *	40x114	1	17"
3LG-3 *	40x114	1	25 1/2"
3LG-4 *	40x114	1	34"
3LG-5 *	40x114	1	42 1/2"
3LG-6 *	40x114	1	50 7/8"
3LG-7 *	40x114	1	59 3/8"
3LG-8 *	40x114	1	74 1/2"
3LG-9 *	40x114	1	100 3/8"
3LG-10	40x114	18	27 1/2"
3LG-11*	40x114	1	115 3/4"
3LG-12	40x114	10	115 3/4"

Wall 2			
Mark	Profile	Count	Cut Length

2BL-1	40x57	2	9 1/2"
2LG-1 *	40x114	1	37"
2LG-2	40x114	34	9 1/2"
2LG-3 *	40x114	1	52 3/8"
2LG-4	40x114	1	115 3/4"
2LG-5	40x114	1	115 3/4"
2LG-6 *	40x114	1	13 5/8"

Wall A			
Mark	Profile	Count	Cut Length

ALG-1	40x114	16	20 1/4"
ALG-2	40x114	9	101 1/8"
ALG-3	40x114	1	101 1/8"
ALG-4	40x114	1	101 1/8"
ATL-1	40x123	1	192 1/8"

Wall B			
Mark	Profile	Count	Cut Length

BLG-1	40x114	19	92 1/2"
BLG-2	40x114	1	92 1/2"
BLG-3	40x114	1	92 1/2"
BTL-1	40x123	1	192 1/8"

Laker Shed B 40 (107 7/8"x176 3/8")

List of all items 4

Wall C			
Mark	Profile	Count	Cut Length



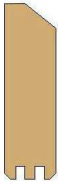

CLG-1	40X114	18	184 1/4"
CLG-2	40X114	1	184 1/4"
CLG-3	40X114	1	184 1/4"
CLG-4	40X114	1	184 1/4"
CTL-1	40X123	1	192 1/8"

Extra logs				
Wall	Mark	Profile	Count	Cut Length

1	EX LG-10	Log 40X114	1	72 7/8"
2	EX LG-4	Log 40X114	1	115 3/4"
3	EX LG-12	Log 40X114	1	115 3/4"
A	EX LG-2	Log 40X114	1	101 1/8"
B	EX LG-1	Log 40X114	1	92 1/2"
C	EX LG-1	Log 40X114	1	184 1/4"

Log Profiles 1	
Profile	Profile
40X123	

Log profiles 2	
Profile	Profile

40X57	
40X114	
40X114	
40X123	
40X123	