

Victoria D 40 (330x330)

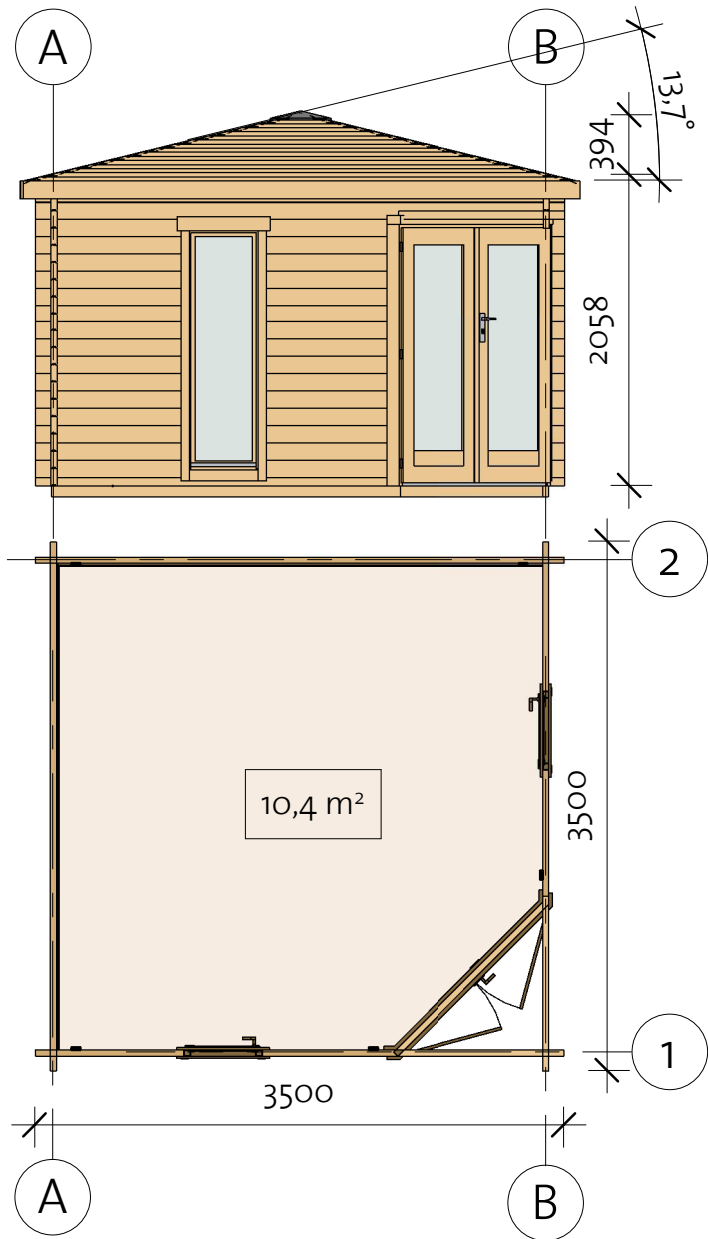



91807204_220608

EZ Log Structures
Do-It-Yourself Building Kits

Victoria D 40 (330x330)

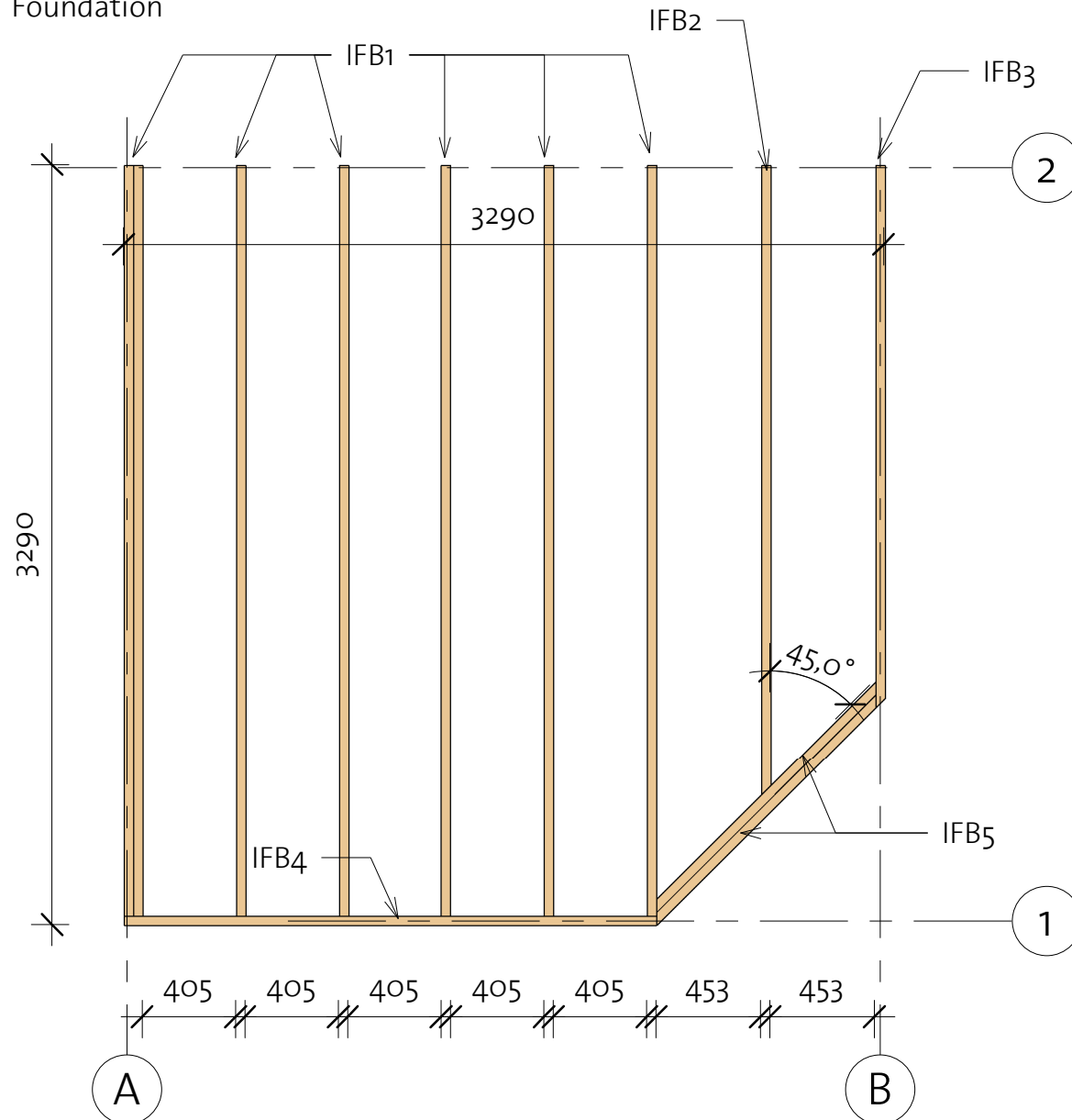
Foundation



Impregnated foundation beams				
Mark	Type	Profile	Count	Length
IFB1	IFB 40x70		7	3250
IFB2	IFB 40x70		1	2724
IFB3	IFB 40x70		1	2345
IFB4	IFB 40x70		1	2305
IFB5	IFB 40x70		2	1376

91807204_220608

Victoria D 40 (330x330)

Floor Plan

① Baseboard

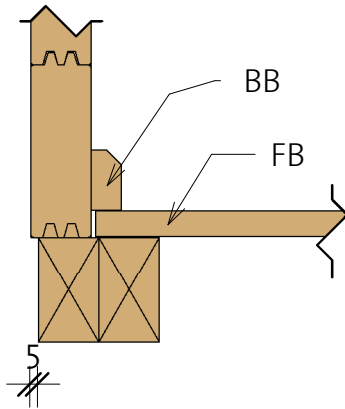

Floor Schedule				
Mark	Type	Profile	Count	Length

FB1	FB 17x114		1	2361
FB2	FB 17x114		1	2475
FB3	FB 17x114		1	2589
FB4	FB 17x114		1	2703
FB5	FB 17x114		1	2817
FB6	FB 17x114		1	2931
FB7	FB 17x114		1	3045
FB8	FB 17x114		1	3159
FB9	FB 17x114		1	3217
FB10	FB 17x114		21	3217

BB1	BB 20x40		4	3300
-----	----------	---	---	------

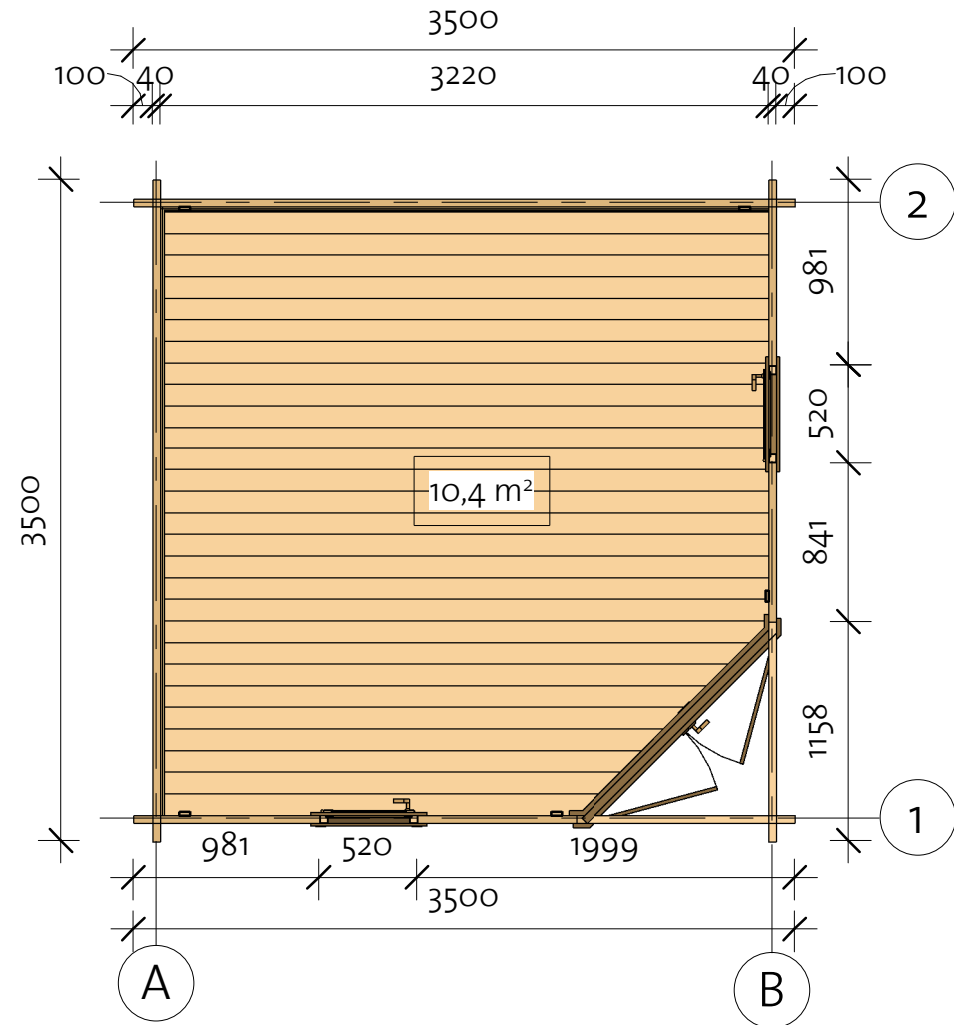

91807204_220608

Victoria D 40 (330x330)

Wall 1

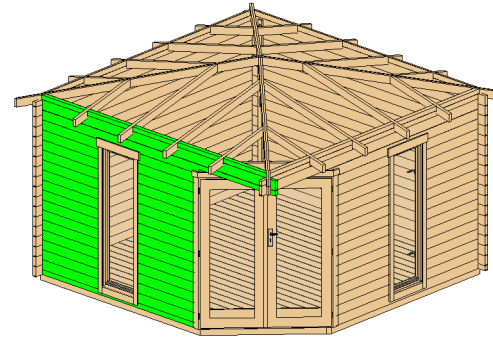

Wall 1			
Mark	Profile	Count	Cut Length

1BL-1	40x57	1	2342
1LG-1	40x114	15	841
1LG-2	40x114	15	981
1LG-3	40x114	1	3500
1LG-4	40x114	1	3500
1TL-1	40x63	1	624
1TL-2	40x63	3	612
1TL-3	40x63	1	624

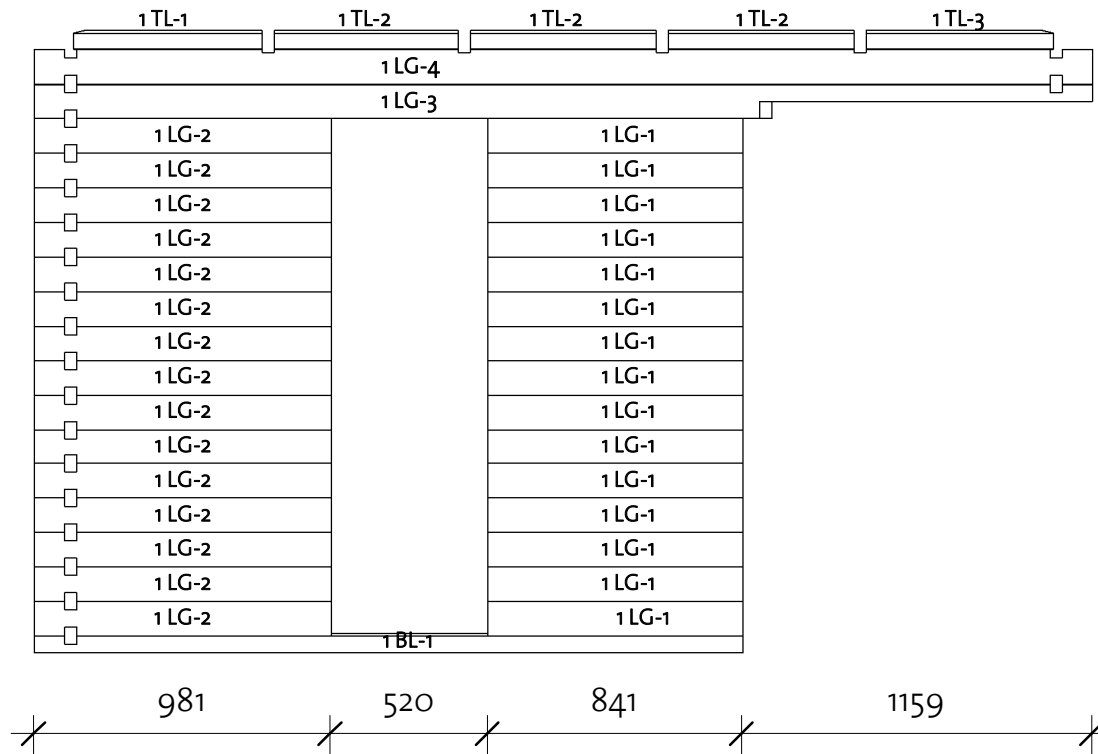

Log Profile Wall 1	
Profile	Profile

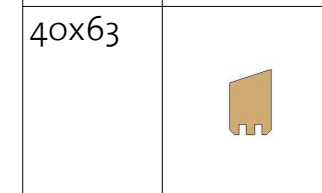
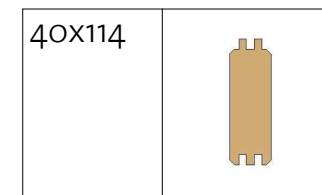

Log Profile Wall 1	
Profile	Profile

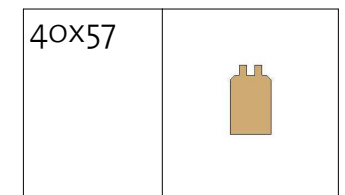

Victoria D 40 (330x330)

Wall 2

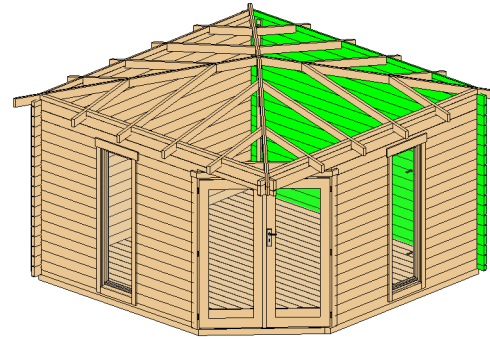

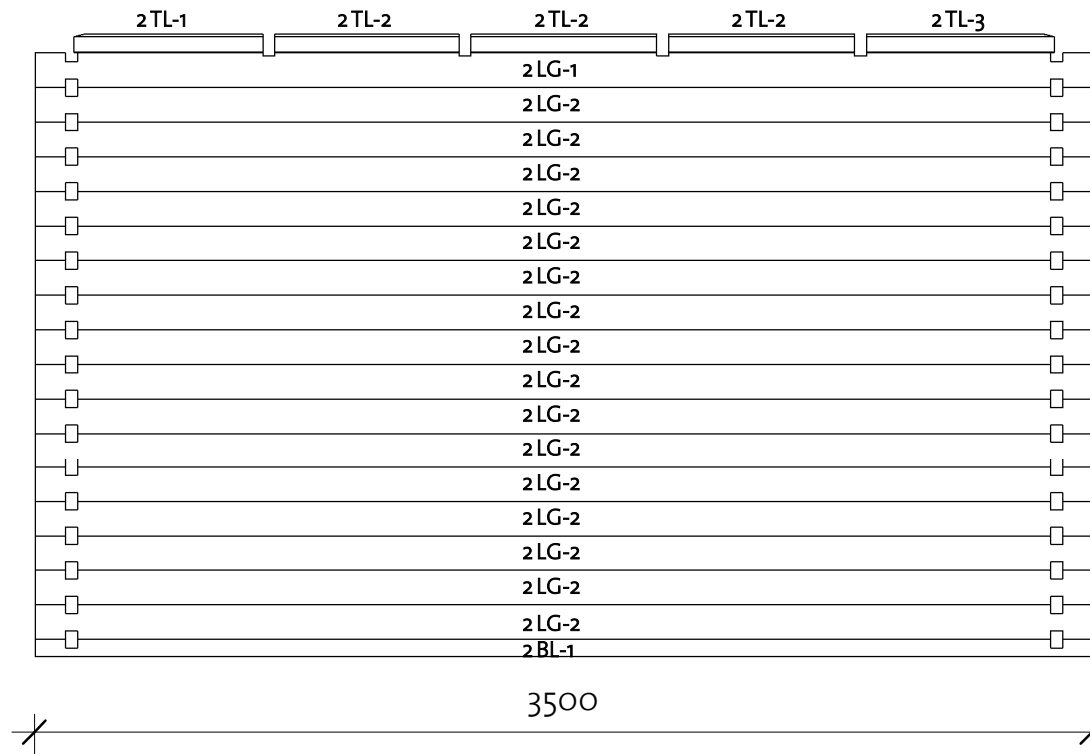

Wall 2			
Mark	Profile	Count	Cut Length

2TL-1	40x63	1	624
2TL-2	40x63	3	612
2TL-3	40x63	1	624
2BL-1	40x57	1	3500
2LG-1	40x114	1	3500
2LG-2	40x114	16	3500



Log Profile Wall 2	
Profile	Profile

40x114	
40x63	

Log Profile Wall 2	
Profile	Profile

40x57	
-------	---

Victoria D 40 (330x330)

Wall A

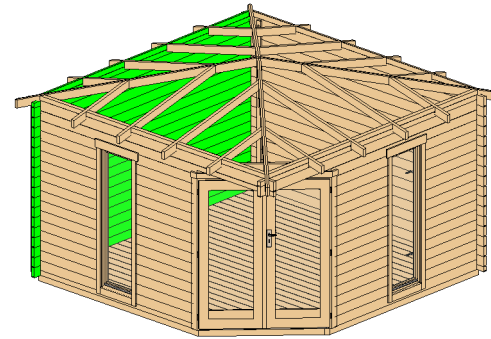

Wall A			
Mark	Profile	Count	Cut Length

ATL-1	40x63	1	624
ATL-2	40x63	3	612
ATL-3	40x63	1	624
ALG-1	40x114	17	3500
ATL-4	40x57 TL	1	3500

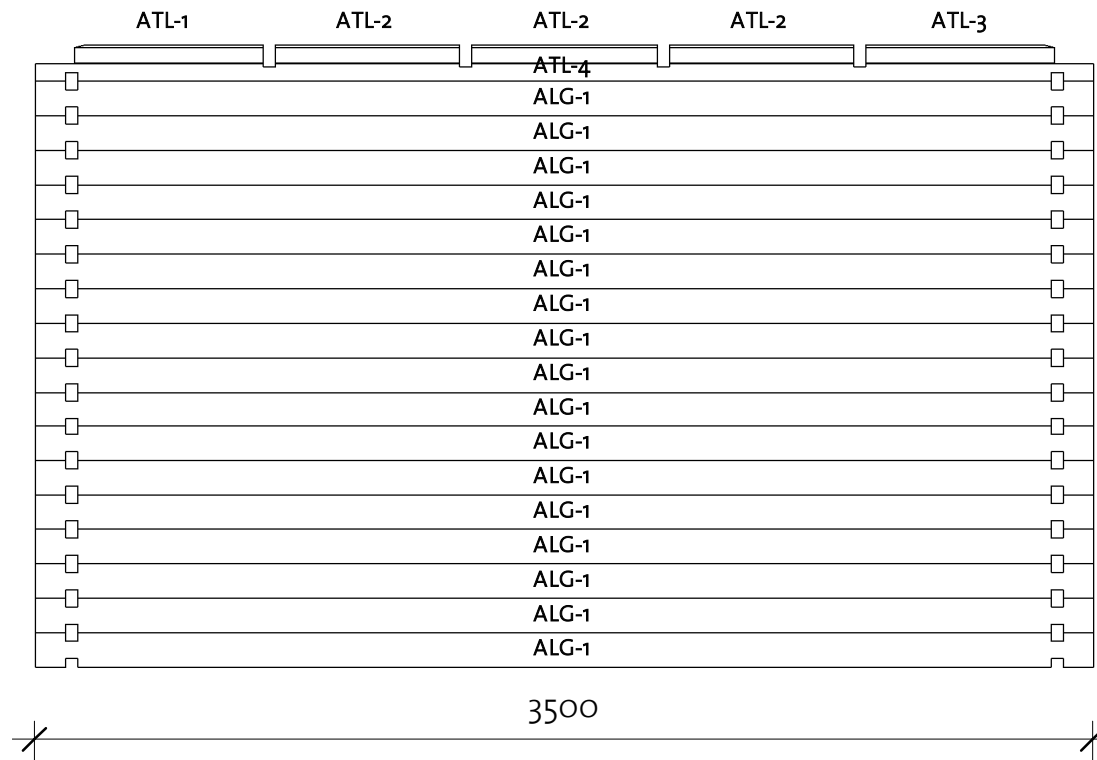

Log Profile Wall A	
Profile	Profile

40x57 TL	
40x63	
40x114	

Victoria D 40 (330x330)

Wall B

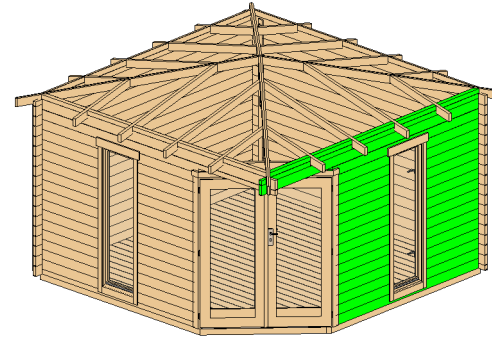

Wall B			
Mark	Profile	Count	Cut Length

BTL-1	40x63	1	624
BTL-2	40x63	3	612
BTL-3	40x63	1	624
BLG-1	40x114	14	841
BLG-2	40x114	1	2438
BLG-3	40x114	14	981
BLG-4	40x114	1	2342
BLG-5	40x114	1	3500
BTL-4	40x57 TL	1	3500

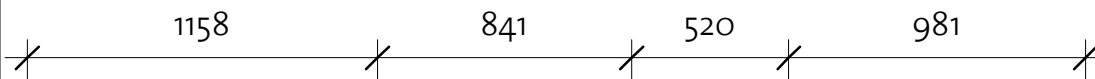
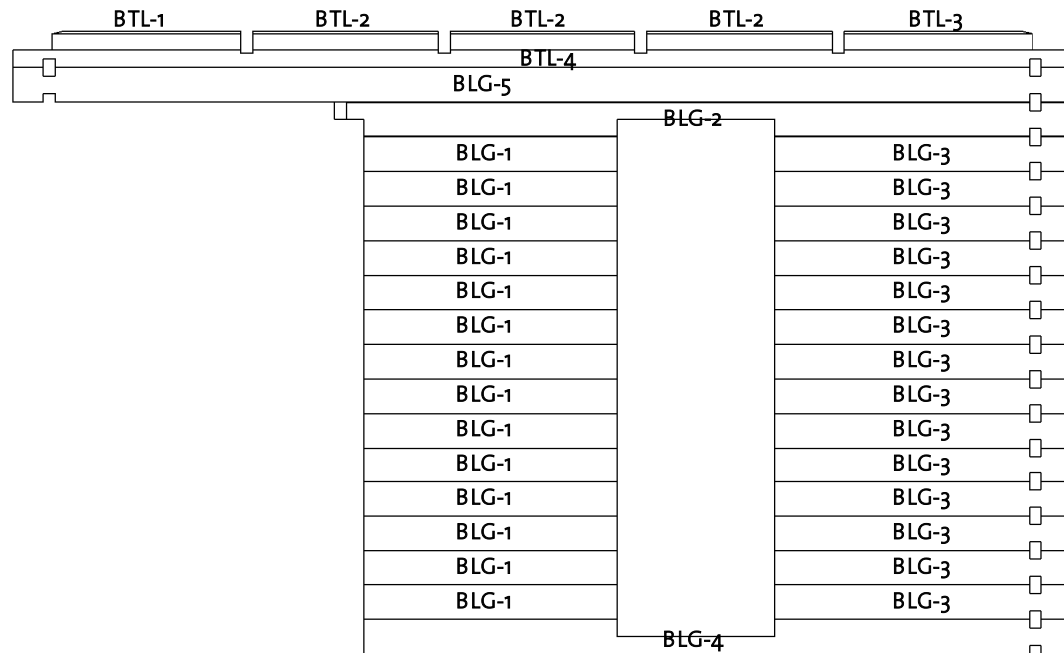

Log Profile Wall B	
Profile	Profile

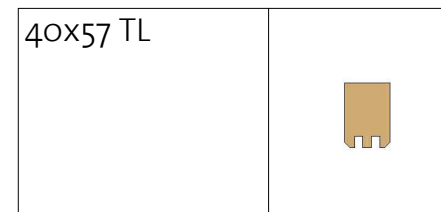

Log Profile Wall B	
Profile	Profile

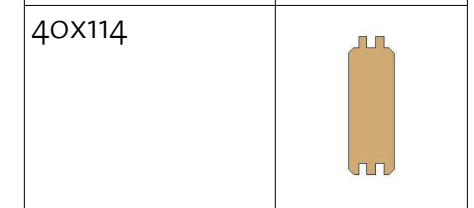
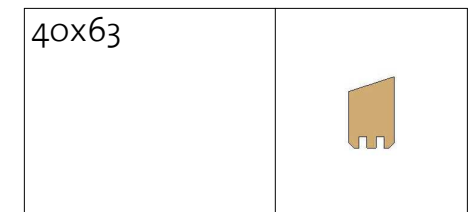

Victoria D 40 (330x330)

Roof 1

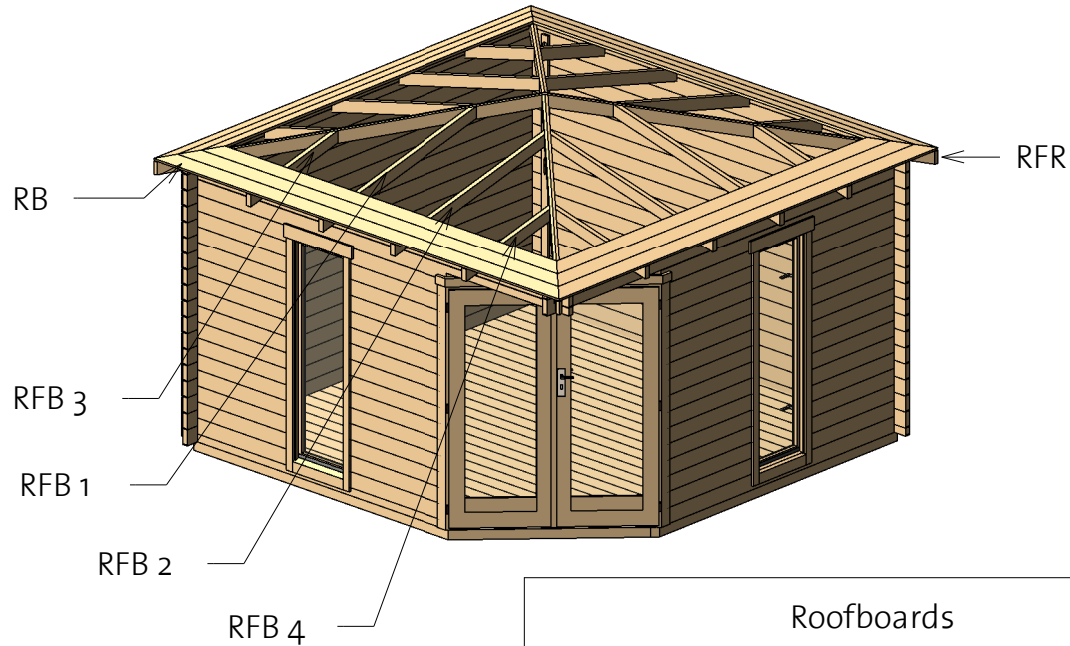

Roofboards				
Mark	Type	Profile	Count	Length

RB1	RoofBoard 17x59		4	123
RB2	RoofBoard 17x114		4	344
RB3	RoofBoard 17x114		4	566
RB4	RoofBoard 17x114		4	787
RB5	RoofBoard 17x114		4	1009
RB6	RoofBoard 17x114		4	1230
RB7	RoofBoard 17x114		4	1452

Roof				
Mark	Type	Profile	Count	Length

RFR	40x94		4	2627
RFB1	40x85		4	1564
RFB2	40x85		4	1564
RFB3	40x85		4	893
RFB4	40x85		4	893

Roofboards				
Mark	Type	Profile	Count	Length

RB8	RoofBoard 17x114		4	1673
RB9	RoofBoard 17x114		4	1895
RB10	RoofBoard 17x114		4	2116
RB11	RoofBoard 17x114		4	2338
RB12	RoofBoard 17x114		4	2559
RB13	RoofBoard 17x114		4	2781
RB14	RoofBoard 17x114		4	3002
RB15	RoofBoard 17x114		4	3224
RB16	RoofBoard 17x114		4	3445
RB17	RoofBoard 17x114		4	3667

Victoria D 40 (330x330)

Roof 2

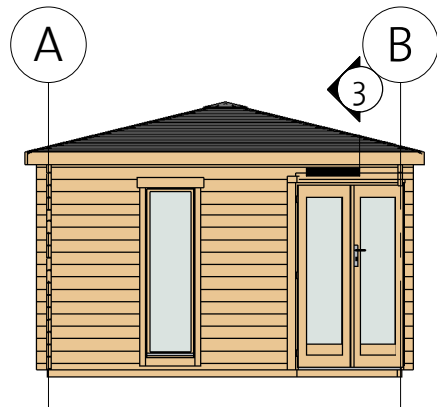

3 Facia

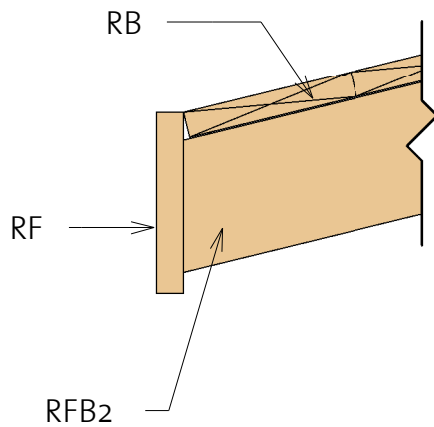

Fascia Schedule				
Mark	Type	Profile	Count	Length
RF	Roof Fascia 18x120		4	3685

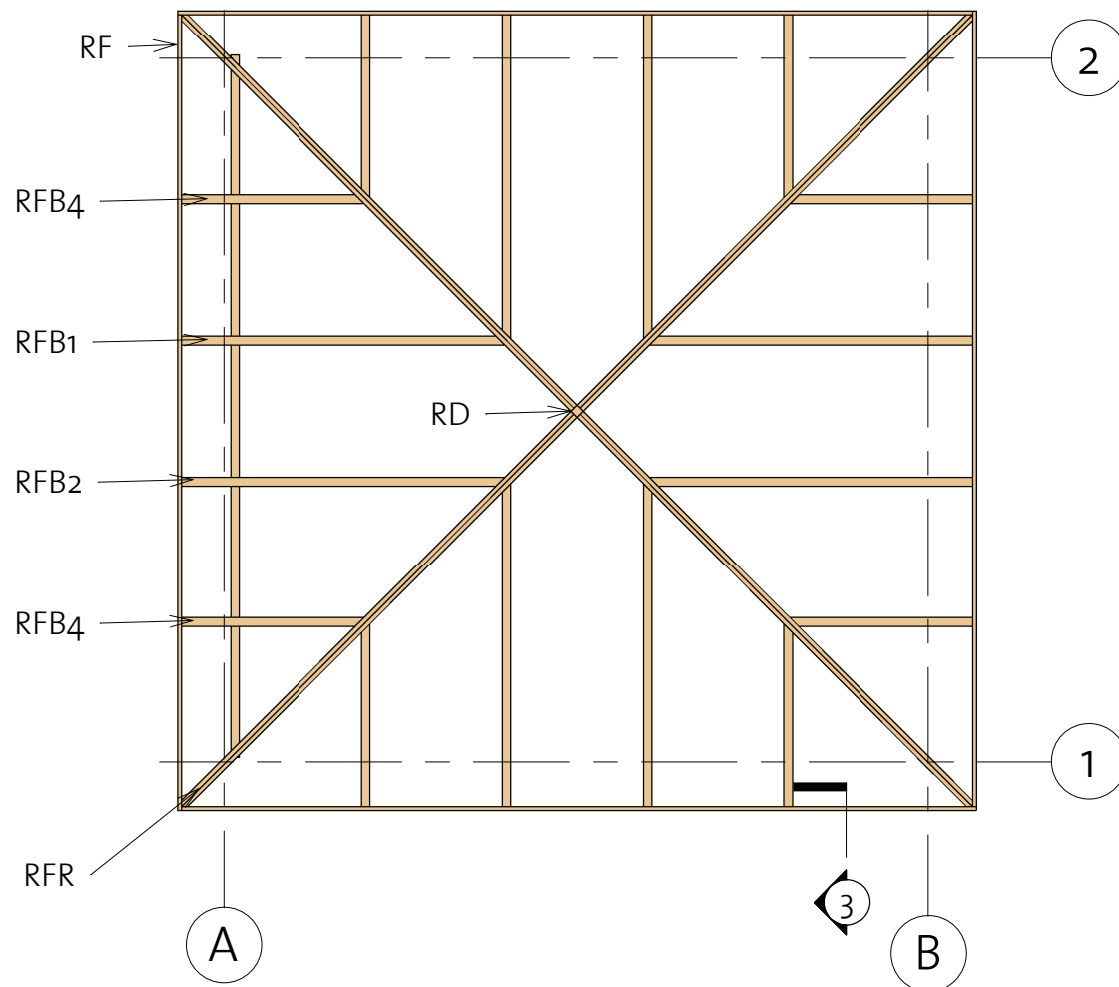

Victoria D 40 (330x330)

Extras

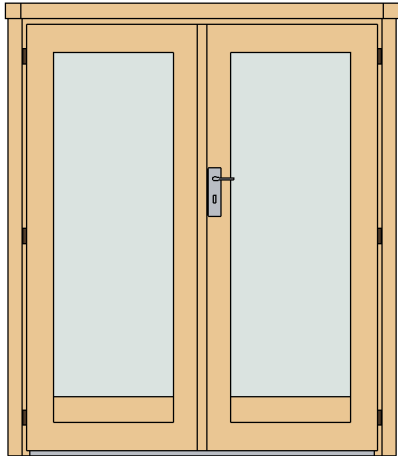

Door Schedule				
Model	Type	Width	Height	Count
CDD13R	Classic double door 13, full glass right	1425	1736	1
DCB8	Door crossbar 8 optional	--	--	2

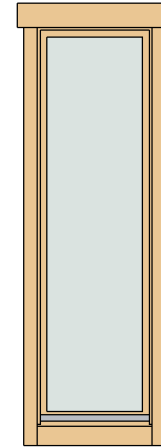

Window Schedule				
Model	Type	Width	Height	Count
CW13R	Classic window 13, full class right	515	1670	2
WCB8	Window crossbar 8 optional	--	--	2

Fasteners & Extras		
Name	Type	Count

Bolts	M8 x 70	15
Hitblock	300-400 mm	
Nails	1,4 x 40	40
Screws	4,0 x 40	915
Screws	5,0 x 70	60
Screws	6,0 x 140	110



Type	Count	Length
------	-------	--------

Windboard 18x40	5	2200
-----------------	---	------

Roof Detdail		
Mark	Type	Count

RD	Roof detail	1
----	-------------	---

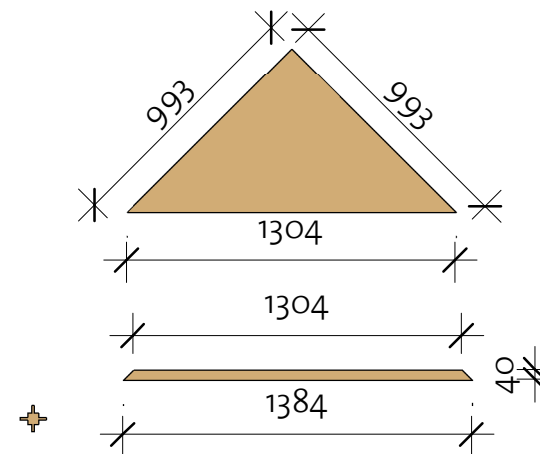

① Roof top 14°

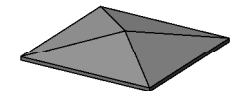

Type	Mark	Count
------	------	-------

Ceiling detail 40x120	CD	1
Ceiling triangle	CT	1

- * Windows intended for tilt opening only!
- * Fenster zur Eröffnung nur zum Kippen vorgesehen!
- * Aknad on ette nähtud ainult kaldu avamiseks!

Victoria D 40 (330x330)

List of all items 1

Impregnated foundation beams				
Mark	Type	Profile	Count	Length

IFB1	IFB 40x70		7	3250
IFB2	IFB 40x70		1	2724
IFB3	IFB 40x70		1	2345
IFB4	IFB 40x70		1	2305
IFB5	IFB 40x70		2	1376

Floor Schedule				
Mark	Type	Profile	Count	Length

FB1	FB 17x114		1	2361
FB2	FB 17x114		1	2475
FB3	FB 17x114		1	2589
FB4	FB 17x114		1	2703
FB5	FB 17x114		1	2817
FB6	FB 17x114		1	2931
FB7	FB 17x114		1	3045
FB8	FB 17x114		1	3159
FB9	FB 17x114		1	3217
FB10	FB 17x114		21	3217

Roofboards				
Mark	Type	Profile	Count	Length

RB1	RoofBoard 17x59		4	123
RB2	RoofBoard 17x114		4	344
RB3	RoofBoard 17x114		4	566
RB4	RoofBoard 17x114		4	787
RB5	RoofBoard 17x114		4	1009
RB6	RoofBoard 17x114		4	1230
RB7	RoofBoard 17x114		4	1452

Roofboards				
Mark	Type	Profile	Count	Length

RB8	RoofBoard 17x114		4	1673
RB9	RoofBoard 17x114		4	1895
RB10	RoofBoard 17x114		4	2116
RB11	RoofBoard 17x114		4	2338
RB12	RoofBoard 17x114		4	2559
RB13	RoofBoard 17x114		4	2781
RB14	RoofBoard 17x114		4	3002
RB15	RoofBoard 17x114		4	3224
RB16	RoofBoard 17x114		4	3445
RB17	RoofBoard 17x114		4	3667

BB1	BB 20x40		4	3300
-----	-------------	---	---	------

Fascia Schedule				
Mark	Type	Profile	Count	Length

RF	Roof Fascia 18x120		4	3685
----	-----------------------	---	---	------

Victoria D 40 (330x330)

List of all items 2

Wall 1			
Mark	Profile	Count	Cut Length

1BL-1	40x57	1	2342
1LG-1	40x114	15	841
1LG-2	40x114	15	981
1LG-3	40x114	1	3500
1LG-4	40x114	1	3500
1TL-1	40x63	1	624
1TL-2	40x63	3	612
1TL-3	40x63	1	624

Wall 2			
Mark	Profile	Count	Cut Length

2TL-1	40x63	1	624
2TL-2	40x63	3	612
2TL-3	40x63	1	624
2BL-1	40x57	1	3500
2LG-1	40x114	1	3500
2LG-2	40x114	16	3500



Wall A			
Mark	Profile	Count	Cut Length

ATL-1	40x63	1	624
ATL-2	40x63	3	612
ATL-3	40x63	1	624
ALG-1	40x114	17	3500
ATL-4	40x57 TL	1	3500

Wall B			
Mark	Profile	Count	Cut Length

BTL-1	40x63	1	624
BTL-2	40x63	3	612
BTL-3	40x63	1	624
BLG-1	40x114	14	841
BLG-2	40x114	1	2438
BLG-3	40x114	14	981
BLG-4	40x114	1	2342
BLG-5	40x114	1	3500
BTL-4	40x57 TL	1	3500

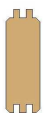
Log Profiles	
Profile	Profile



40x114	
40x63	

Log Profiles	
Profile	Profile

40x57	
40x57 TL	

Victoria D 40 (330x330)

List of all items 3

Roof				
Mark	Type	Profile	Count	Length
RFR	40x94		4	2627
RFB1	40x85		4	1564
RFB2	40x85		4	1564
RFB3	40x85		4	893
RFB4	40x85		4	893

Windboard

① Windboard Assembly 1



② Windboard Assembly 2

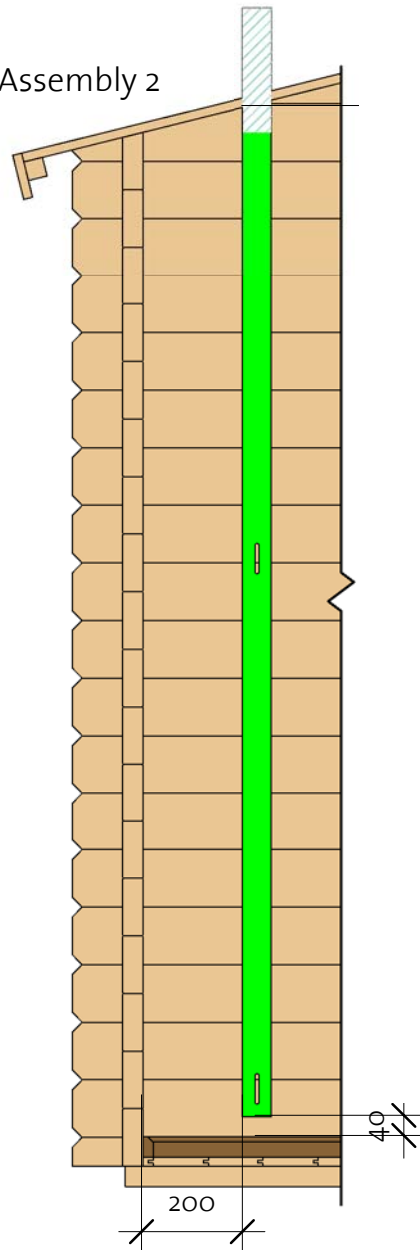

③ Windboard Assembly 3

