

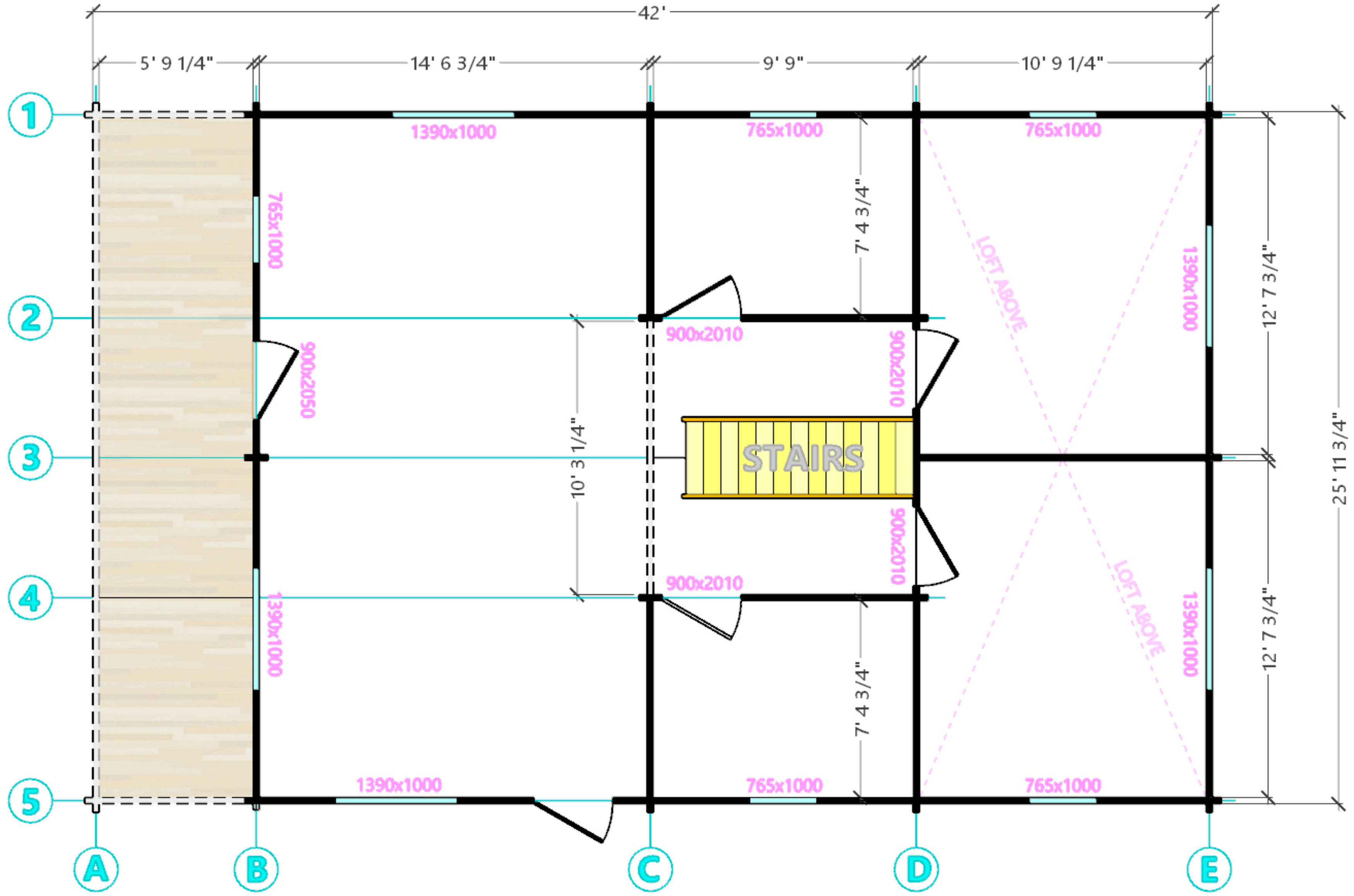

Tom Garland
EZ Log Structures
North America

TULSA (IMPERIAL) FLOOR PLAN

A1



IN-HOUSE DRAWINGS ONLY - SUBJECT TO CHANGE - FINAL ENGINEERING REQUIRED



Tom Garland
EZ Log Structures
North America

TULSA (IMPERIAL) SECOND FLOOR PLAN

A2

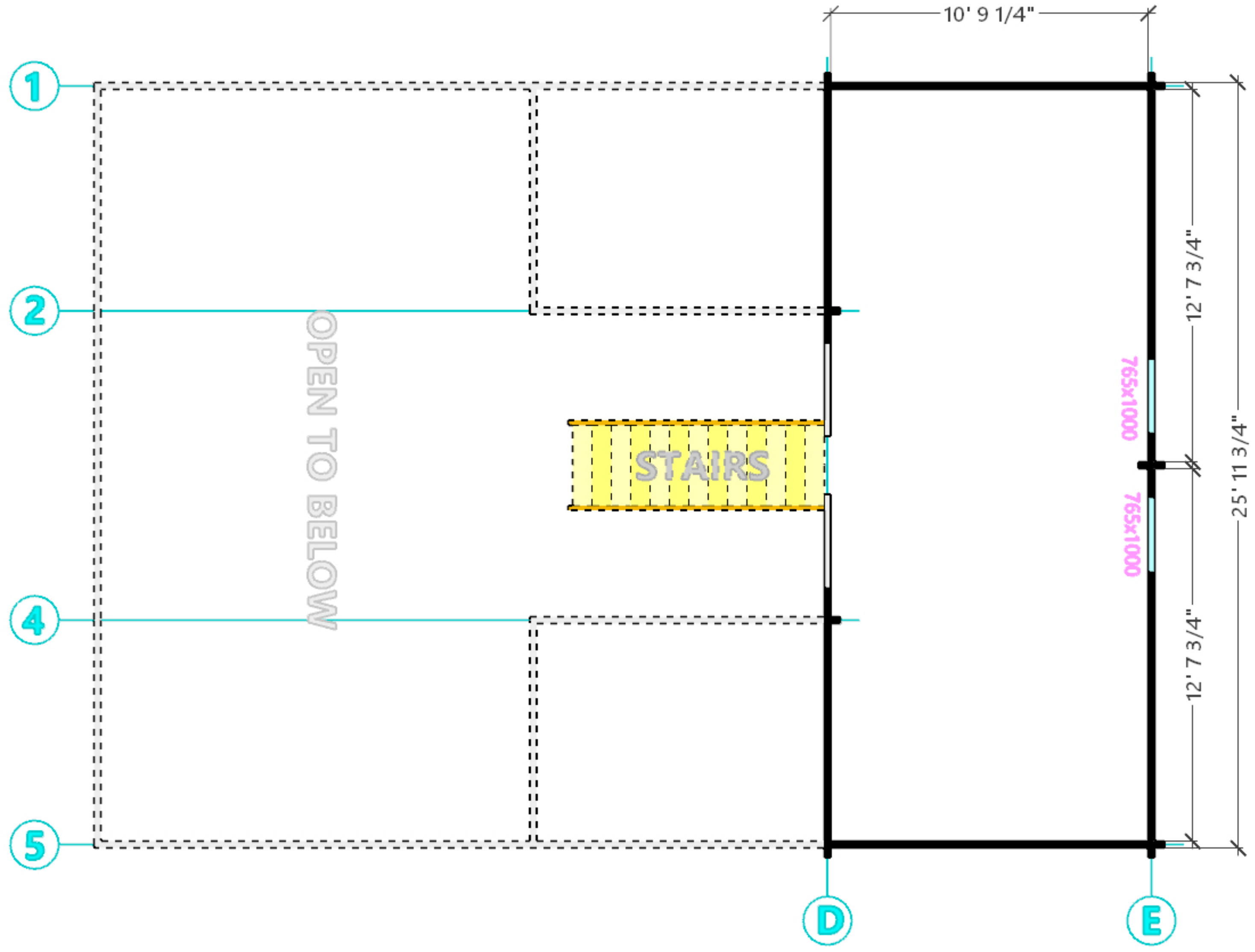

IN-HOUSE DRAWINGS ONLY - SUBJECT TO CHANGE - FINAL ENGINEERING REQUIRED



Tom Garland
EZ Log Structures
North America

TULSA (IMPERIAL) ELEVATIONS

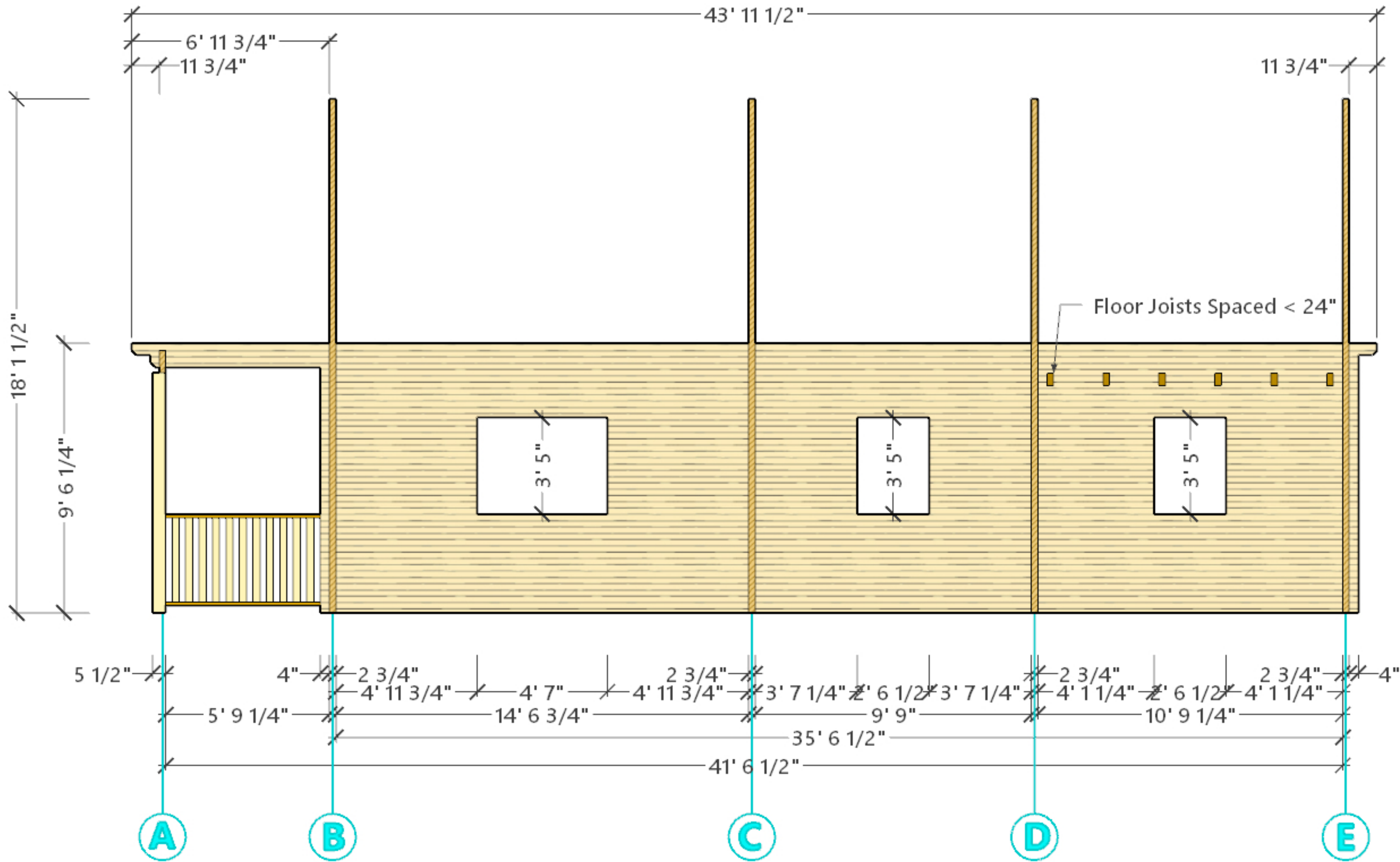

WALL 1 - TULSA

IN-HOUSE DRAWINGS ONLY - SUBJECT TO CHANGE - FINAL ENGINEERING REQUIRED

A3



Tom Garland
EZ Log Structures
North America

TULSA (IMPERIAL) ELEVATIONS

A4

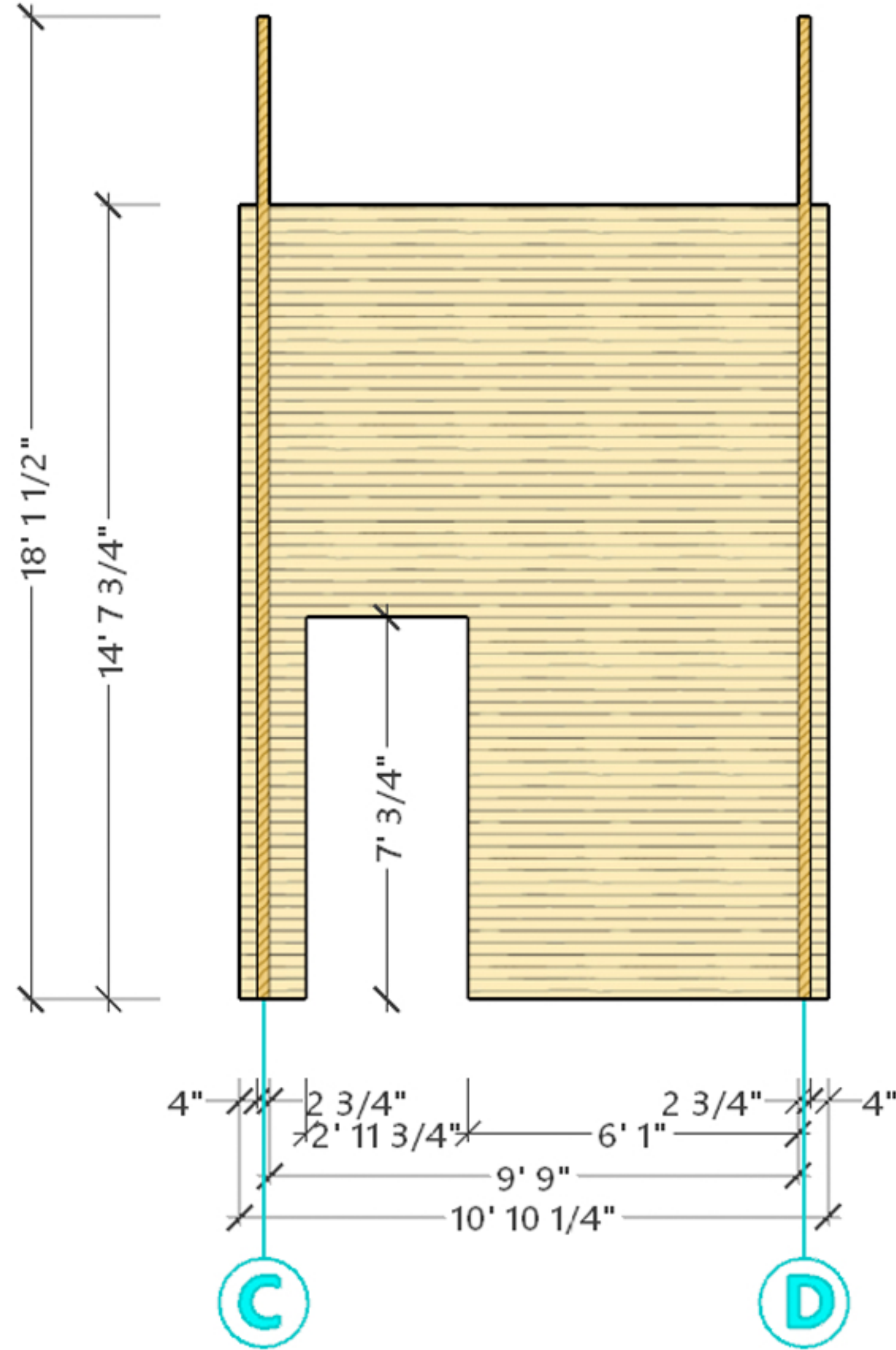

WALLS 2 & 4 - TULSA

IN-HOUSE DRAWINGS ONLY - SUBJECT TO CHANGE - FINAL ENGINEERING REQUIRED



Tom Garland
EZ Log Structures
North America

TULSA (IMPERIAL)
ELEVATIONS

A5

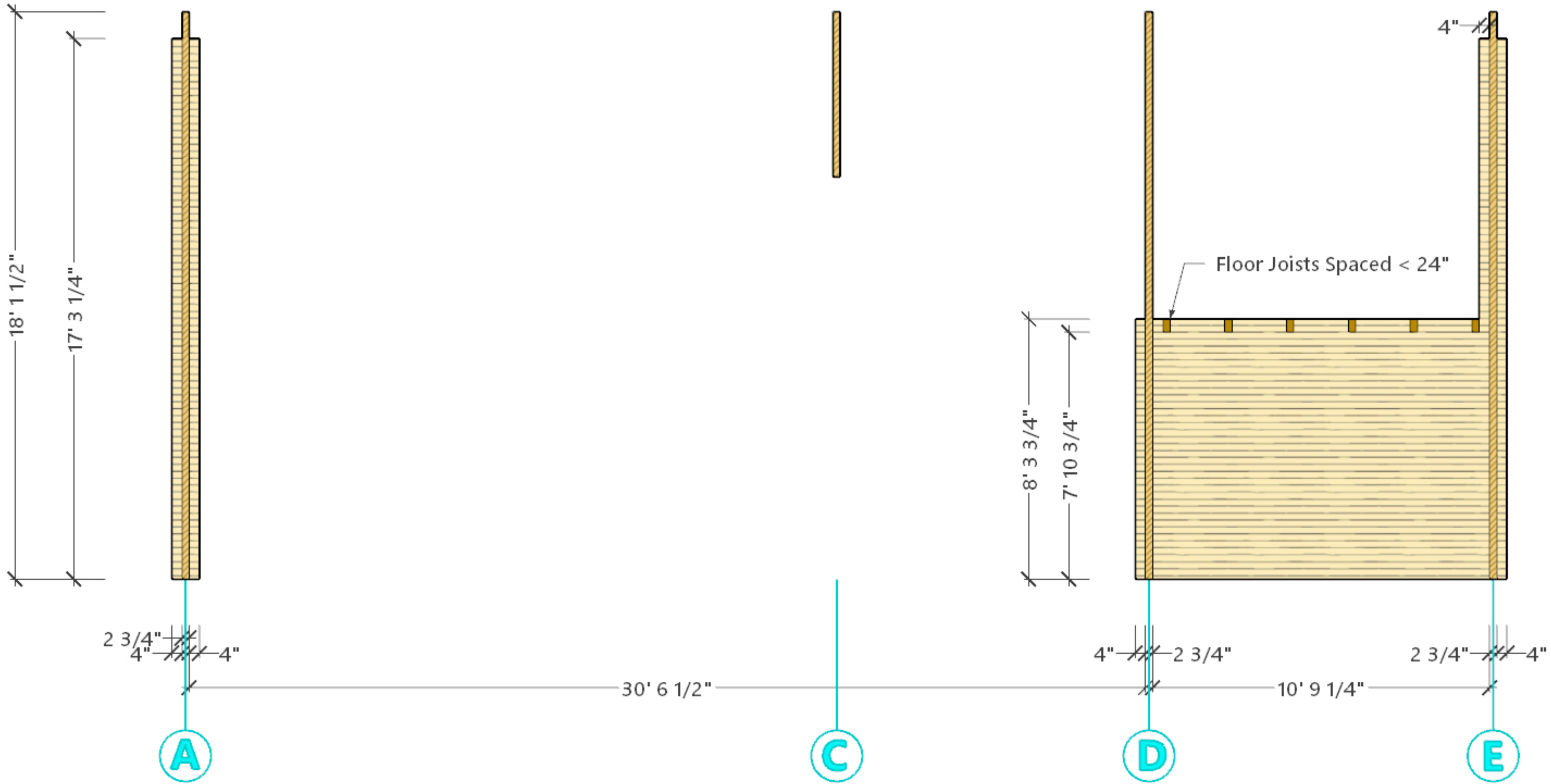

WALL 3 - TULSA

IN-HOUSE DRAWINGS ONLY - SUBJECT TO CHANGE - FINAL ENGINEERING REQUIRED



Tom Garland
EZ Log Structures
North America

TULSA (IMPERIAL) ELEVATIONS

A6

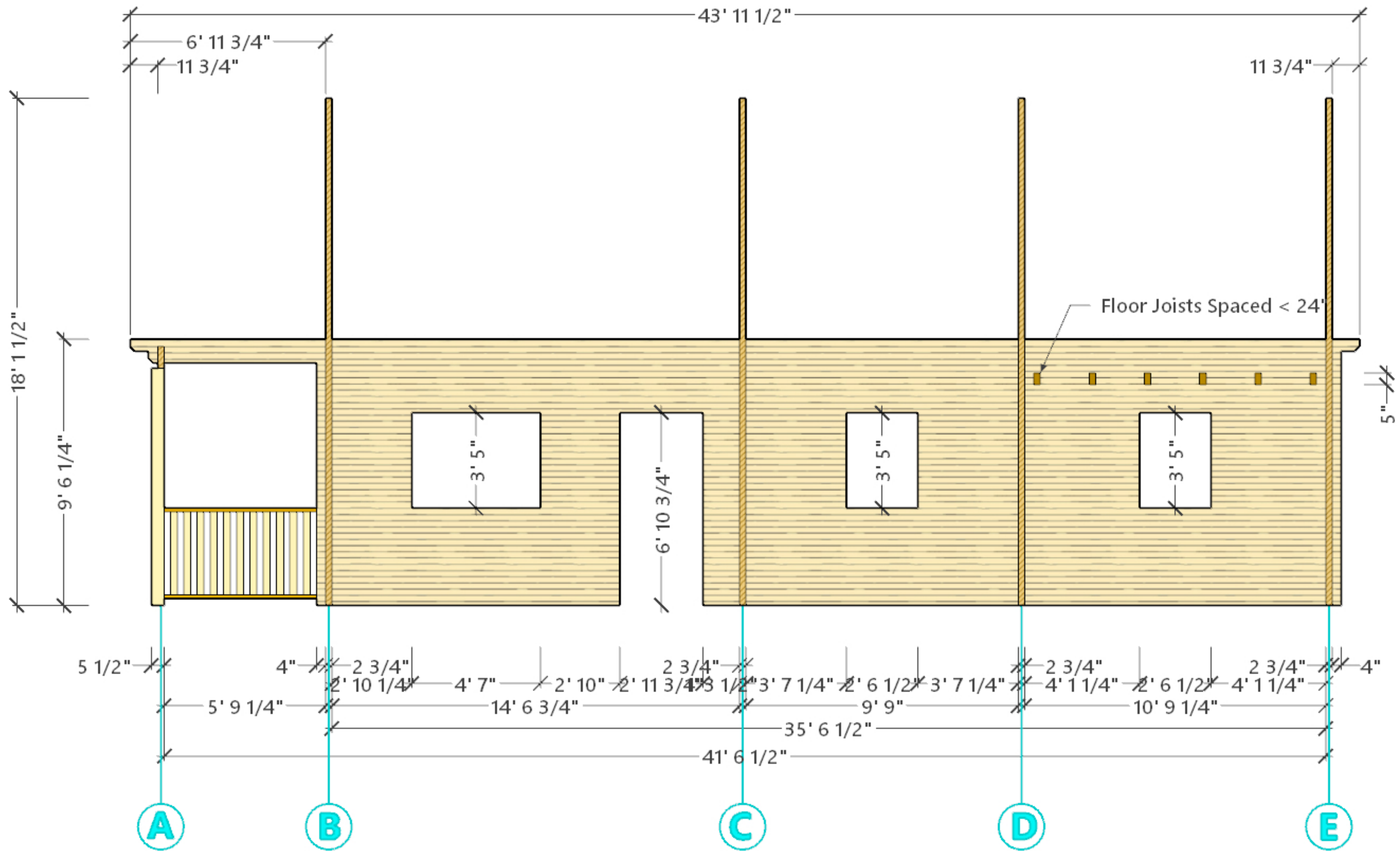

WALL 5 - TULSA

IN-HOUSE DRAWINGS ONLY - SUBJECT TO CHANGE - FINAL ENGINEERING REQUIRED



Tom Garland
EZ Log Structures
North America

TULSA (IMPERIAL) ELEVATIONS

A7

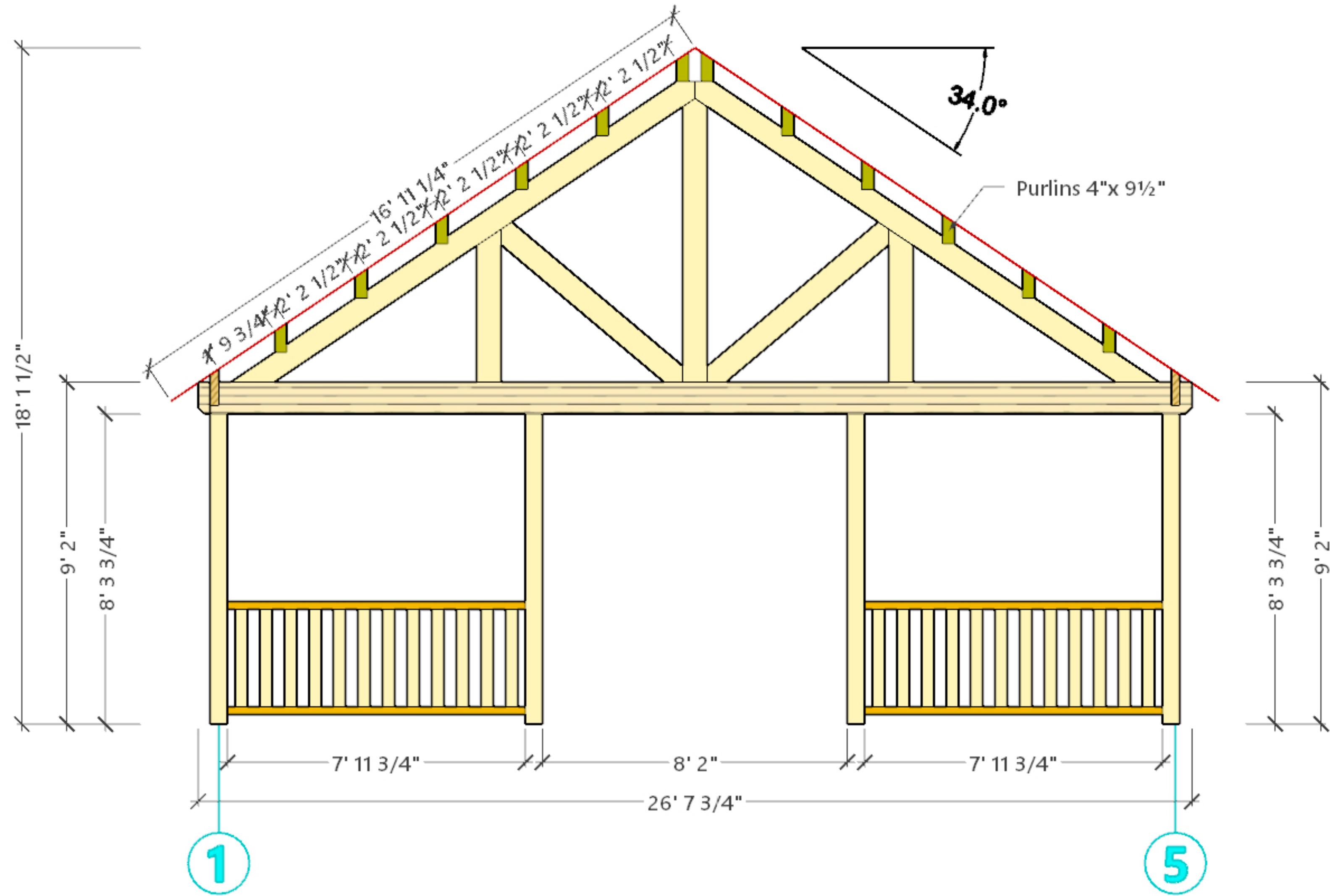

WALL A - TULSA

IN-HOUSE DRAWINGS ONLY - SUBJECT TO CHANGE - FINAL ENGINEERING REQUIRED



Tom Garland
EZ Log Structures
North America

TULSA (IMPERIAL) ELEVATIONS

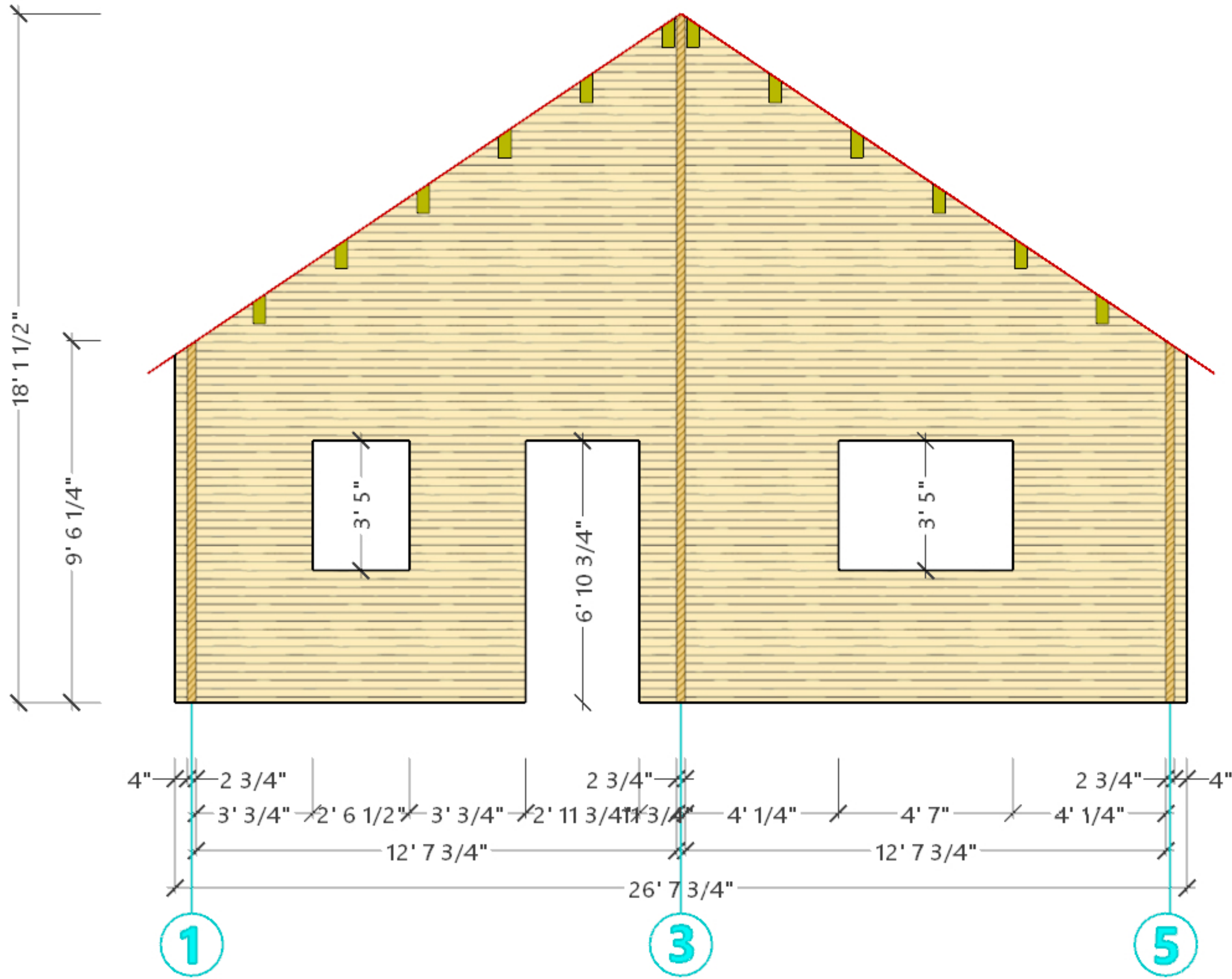

WALL B - TULSA

IN-HOUSE DRAWINGS ONLY - SUBJECT TO CHANGE - FINAL ENGINEERING REQUIRED

A8



Tom Garland
EZ Log Structures
North America

TULSA (IMPERIAL) ELEVATIONS

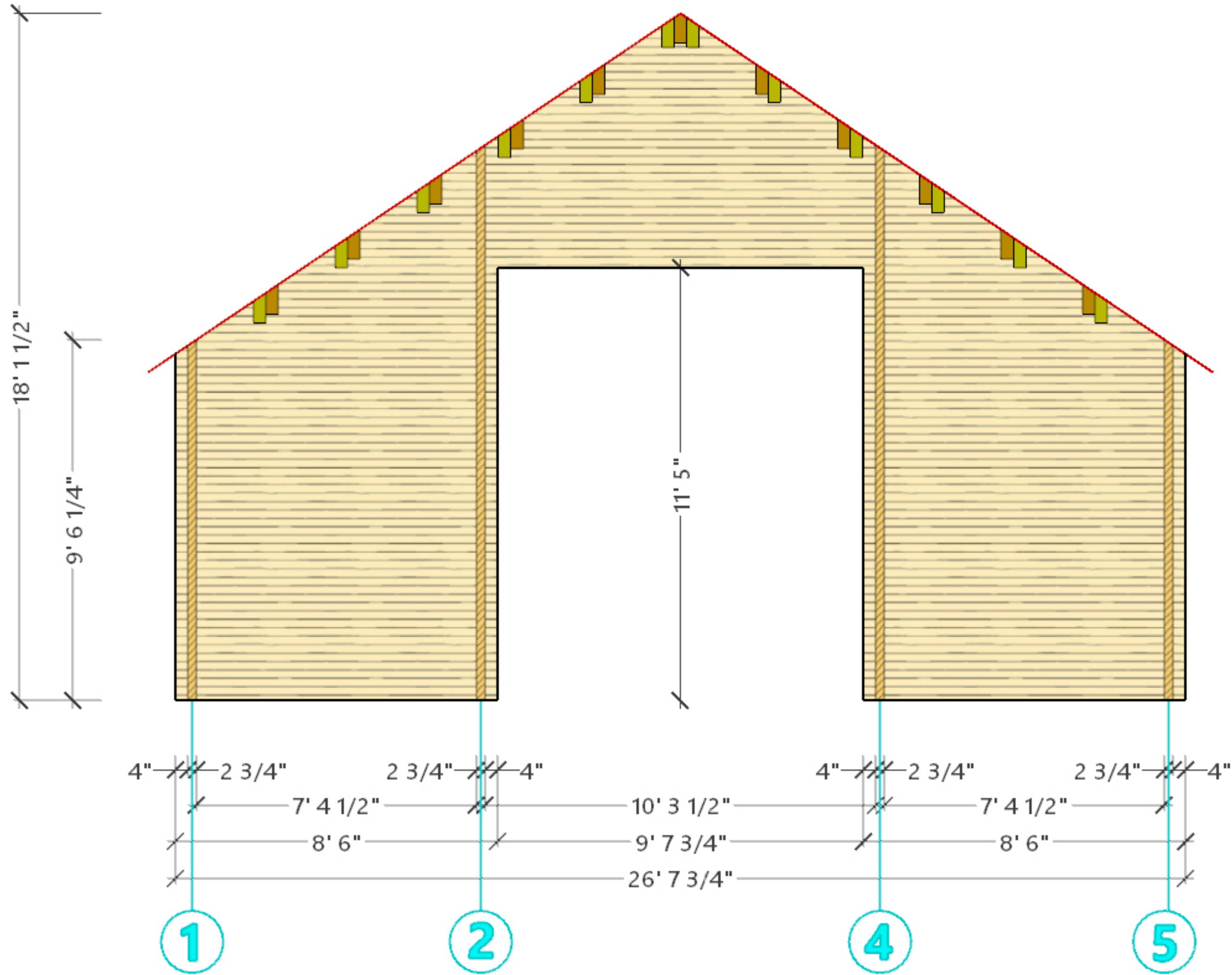

WALL C - TULSA

IN-HOUSE DRAWINGS ONLY - SUBJECT TO CHANGE - FINAL ENGINEERING REQUIRED

A9



Tom Garland
EZ Log Structures
North America

TULSA (IMPERIAL) ELEVATIONS

A10

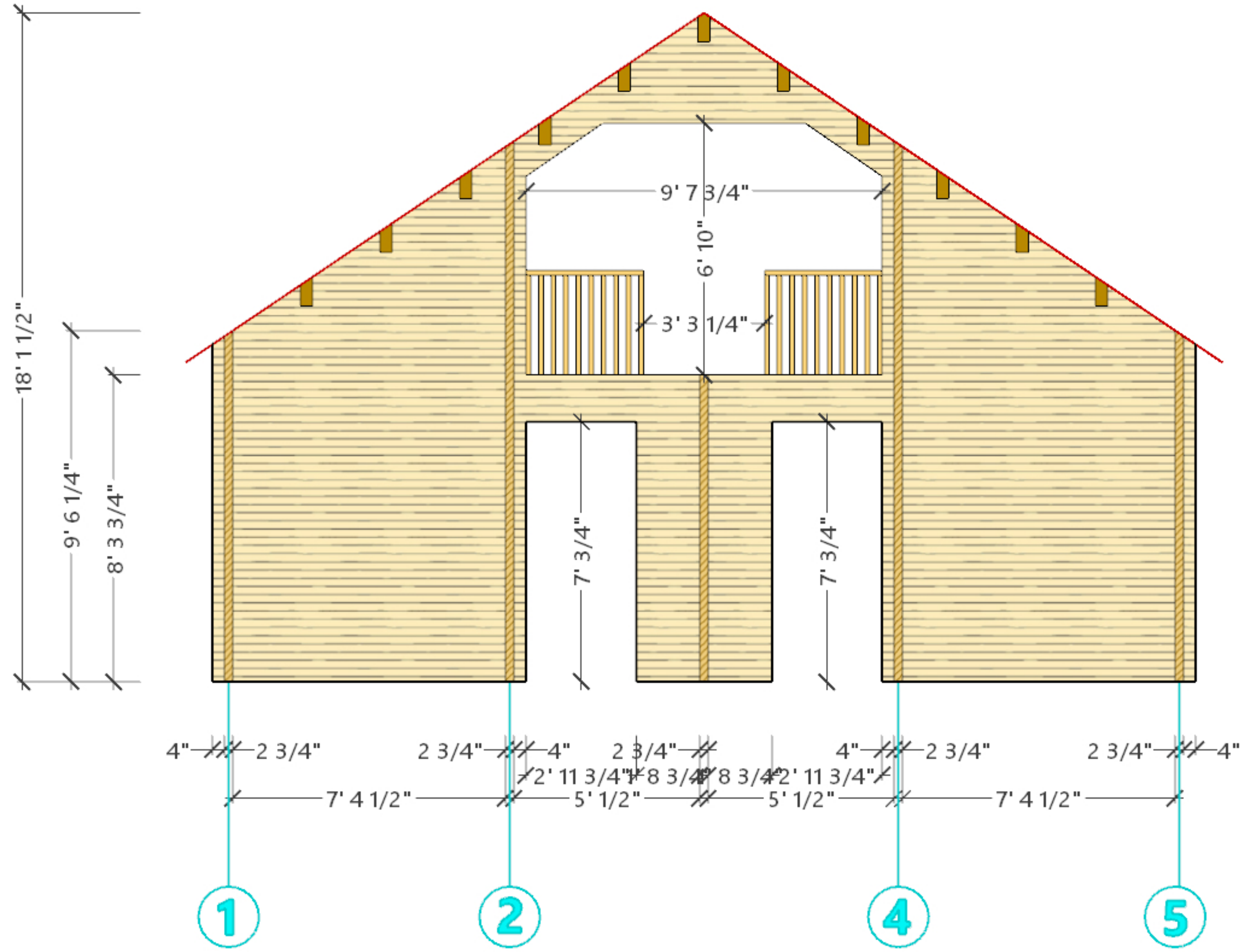

WALL D - TULSA

IN-HOUSE DRAWINGS ONLY - SUBJECT TO CHANGE - FINAL ENGINEERING REQUIRED



Tom Garland
EZ Log Structures
North America

TULSA (IMPERIAL)
ELEVATIONS

A111

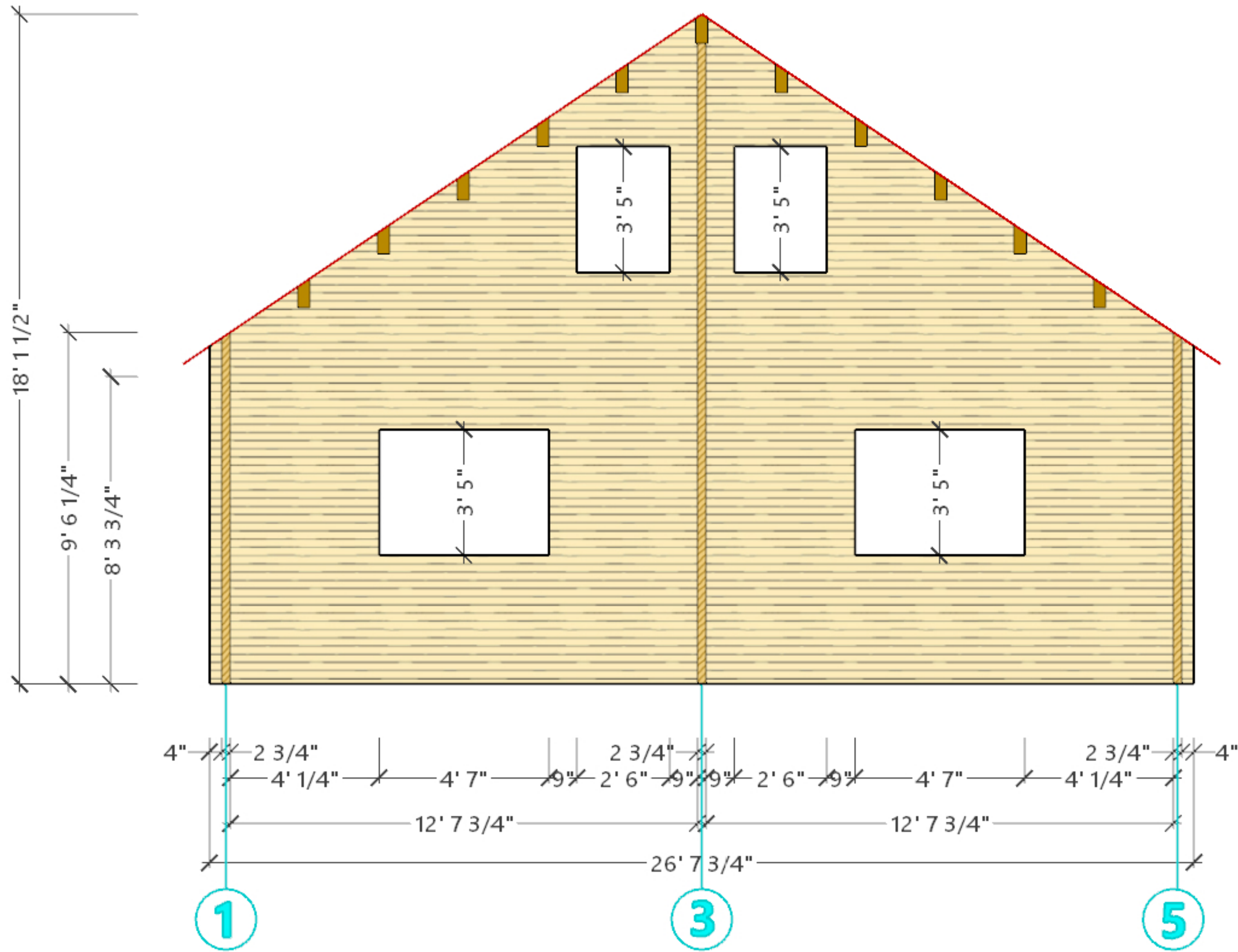

WALL E - TULSA

IN-HOUSE DRAWINGS ONLY - SUBJECT TO CHANGE - FINAL ENGINEERING REQUIRED



Tom Garland
EZ Log Structures
North America

TULSA (IMPERIAL)
DETAILS

D1

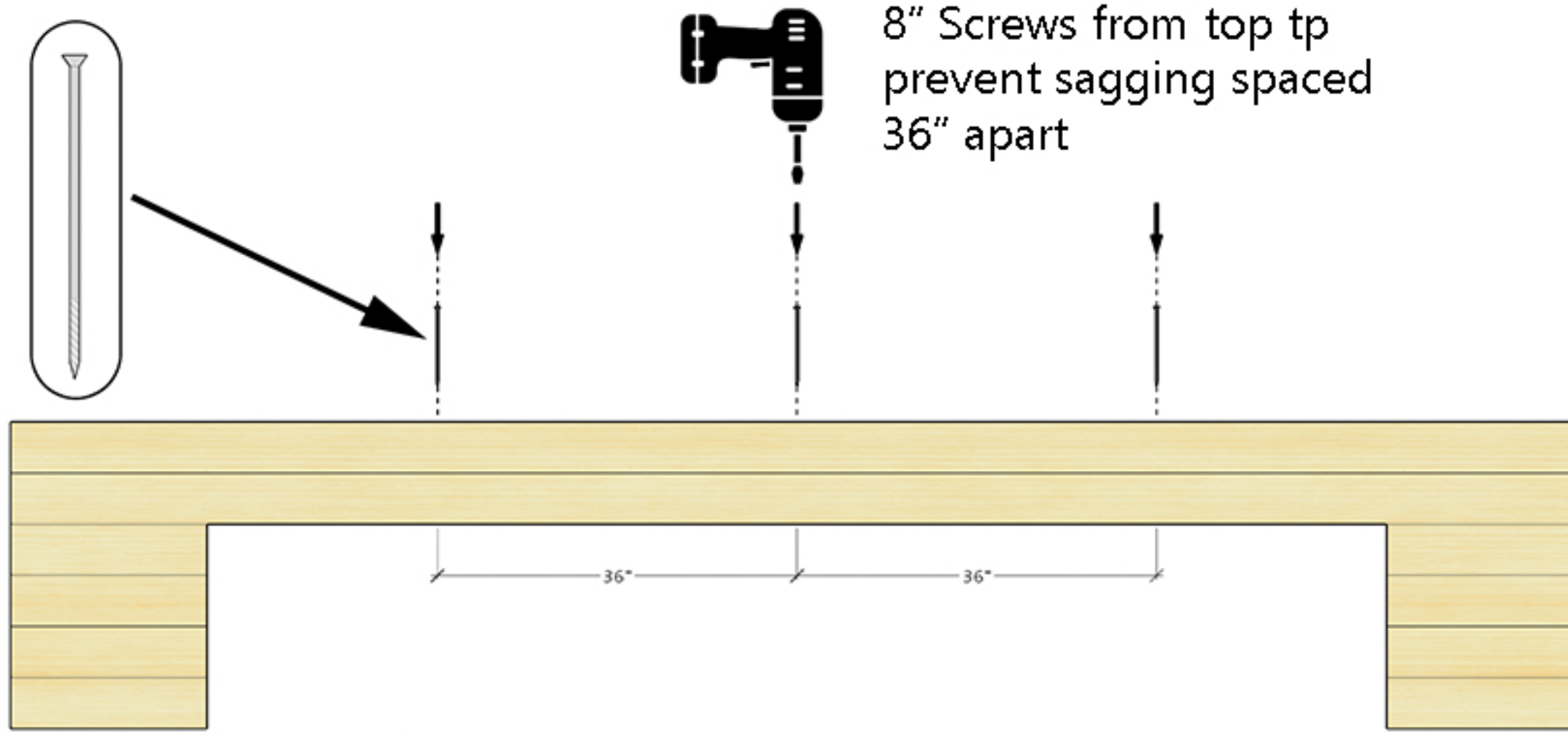

Stacked Beams Over Large Spans

Threaded Bolts at Corners

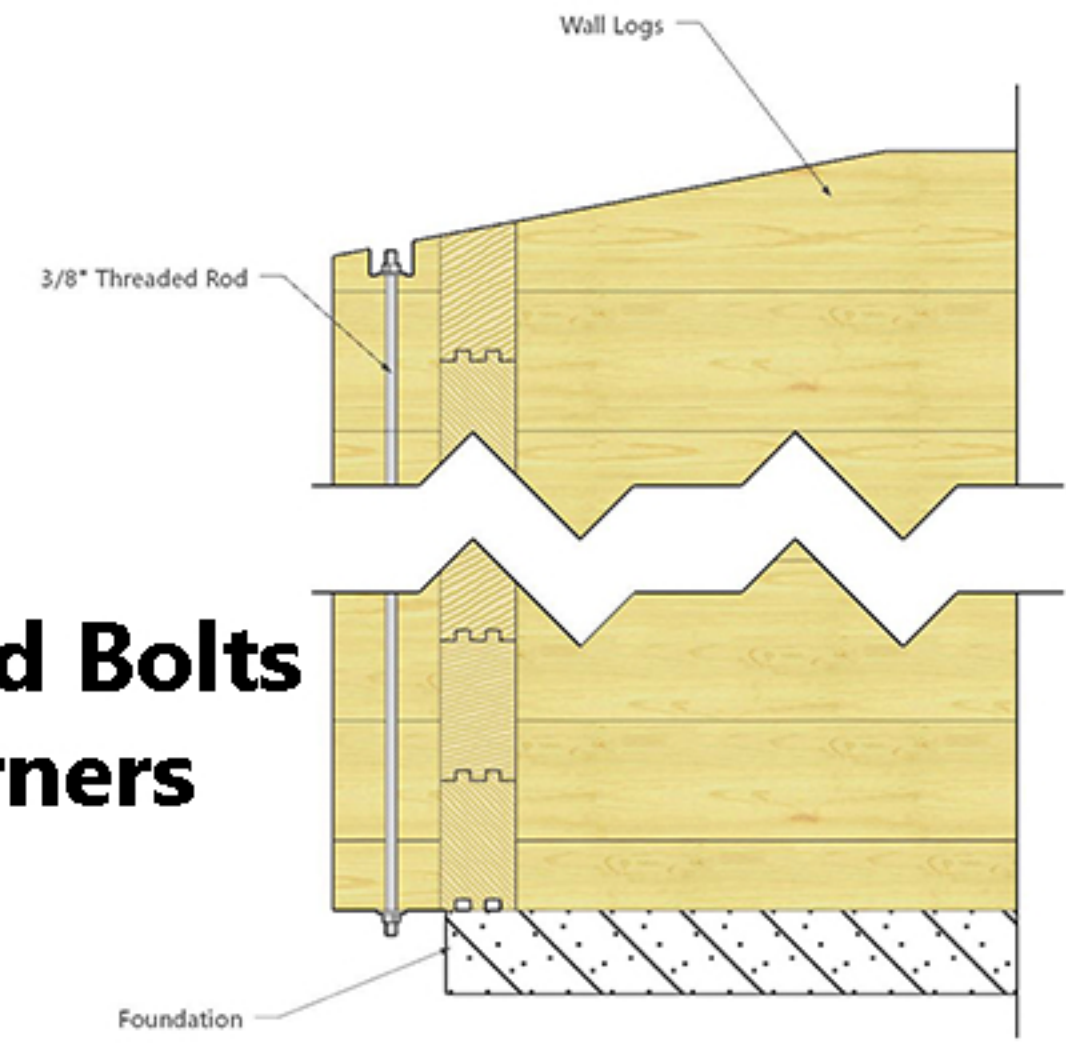

8" Screws from top to prevent sagging

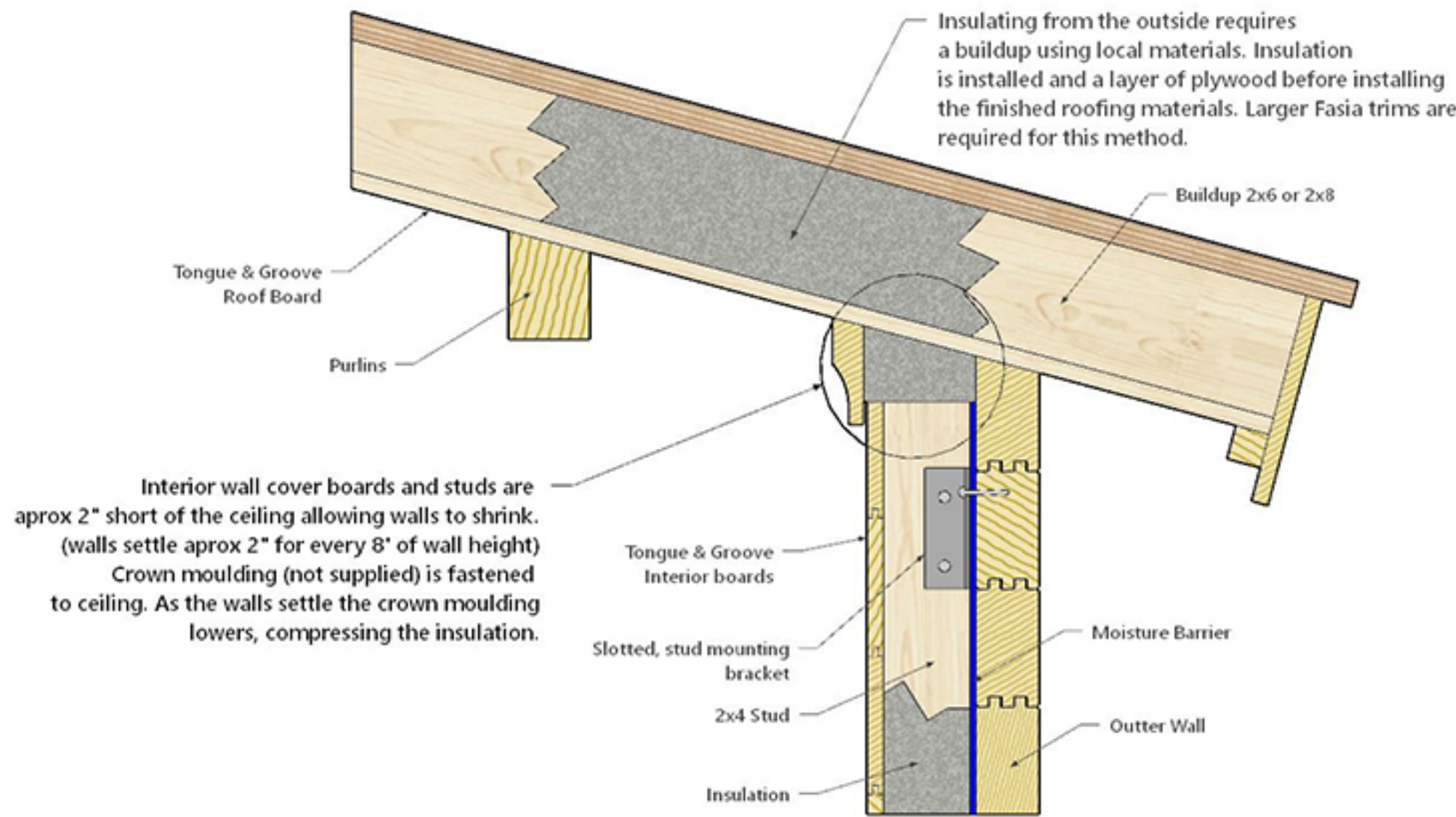
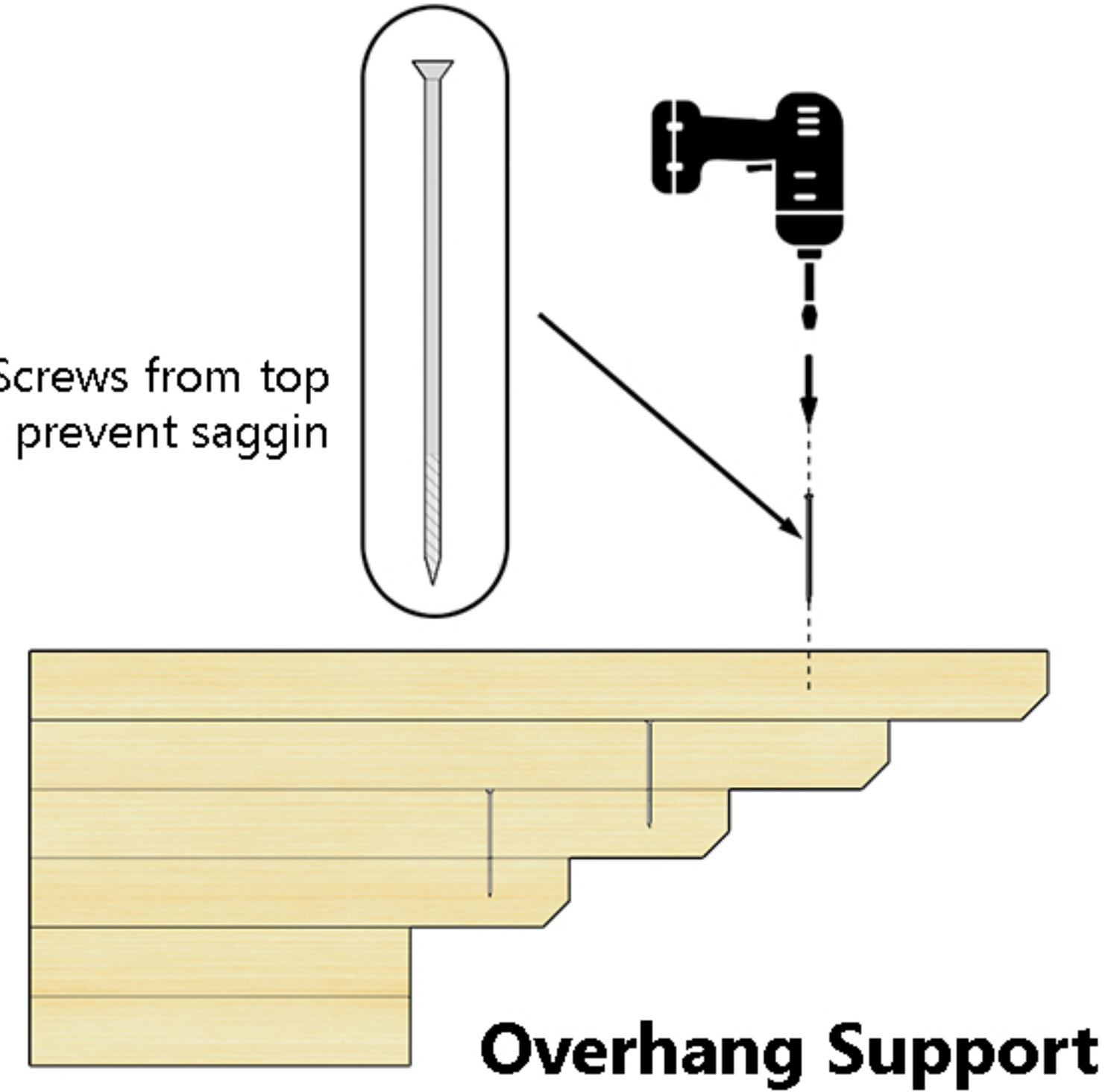

Exterior Roof & Interior Wall Insulation

IN-HOUSE DRAWINGS ONLY - SUBJECT TO CHANGE - FINAL ENGINEERING REQUIRED



Tom Garland
EZ Log Structures
North America

TULSA (IMPERIAL)
DETAILS

D2

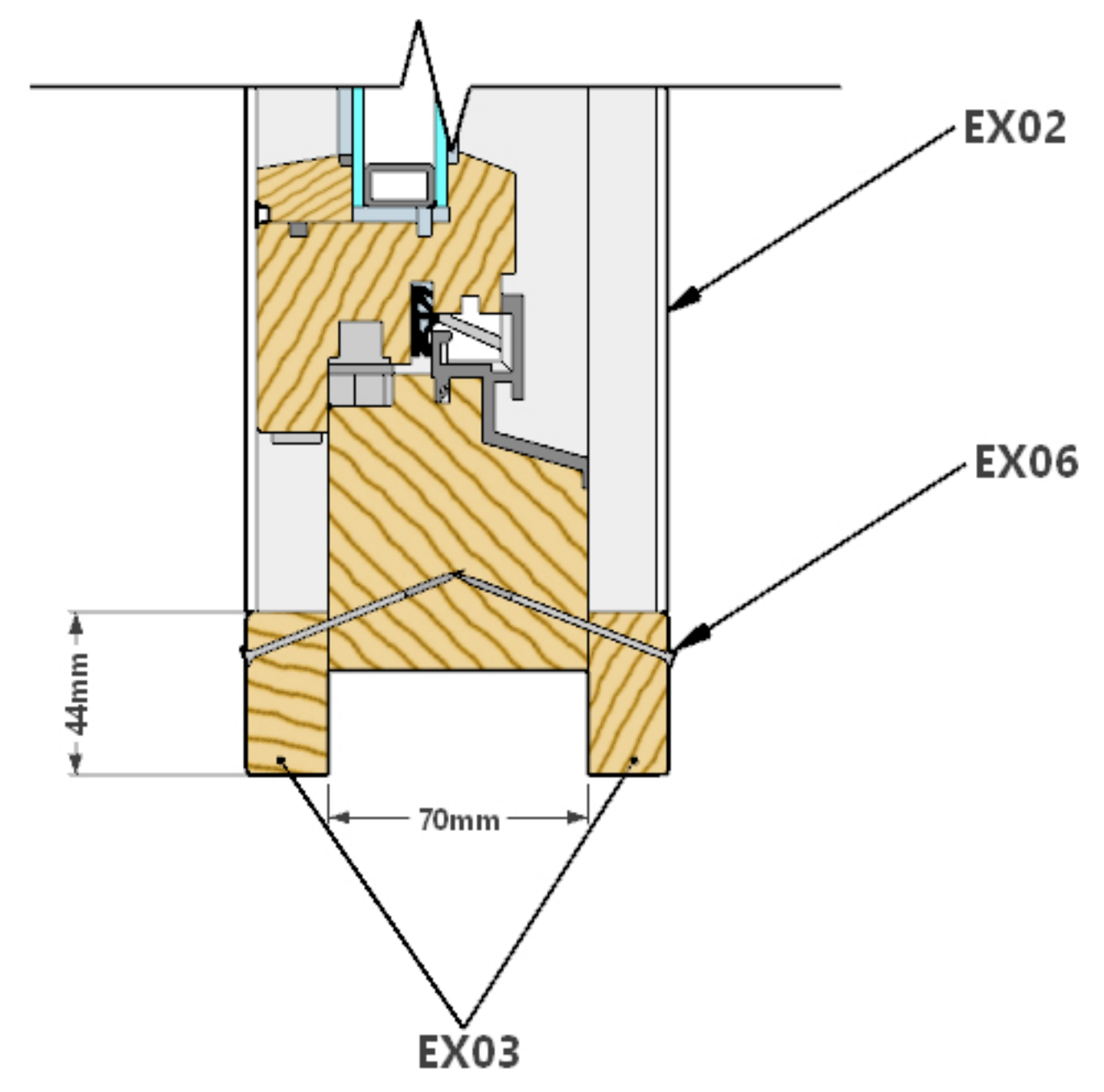
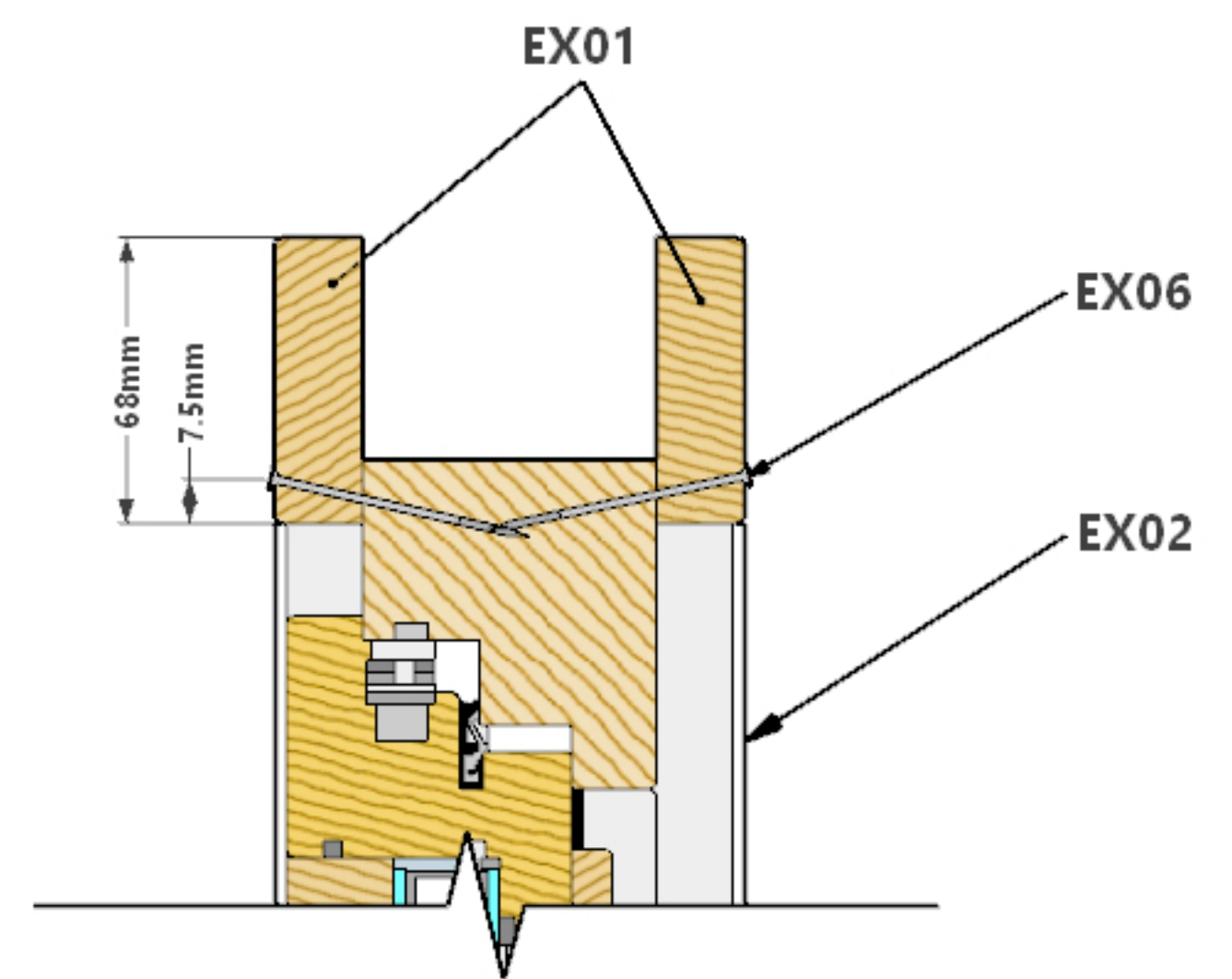

Window Section Detail

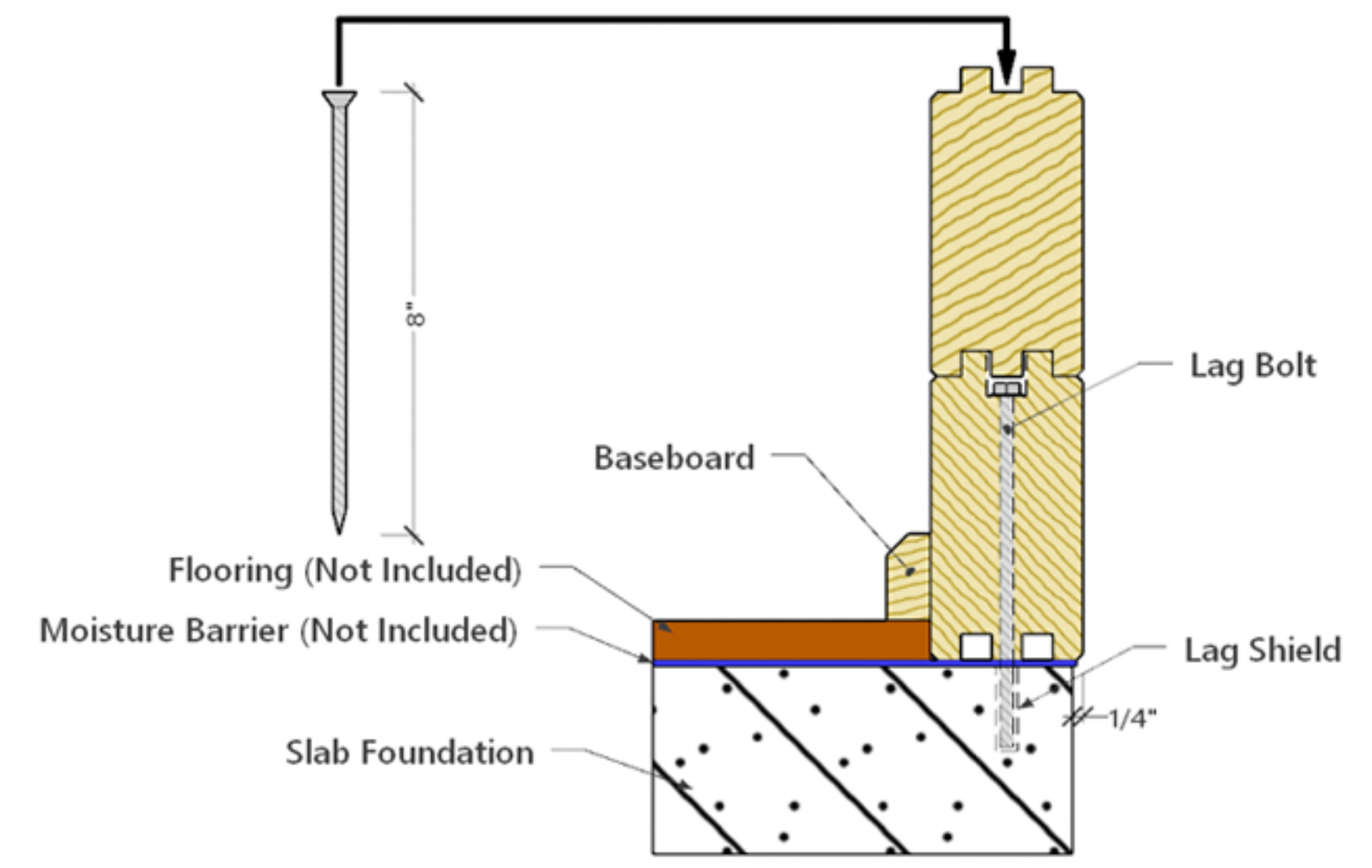

Foundation Connection Slab

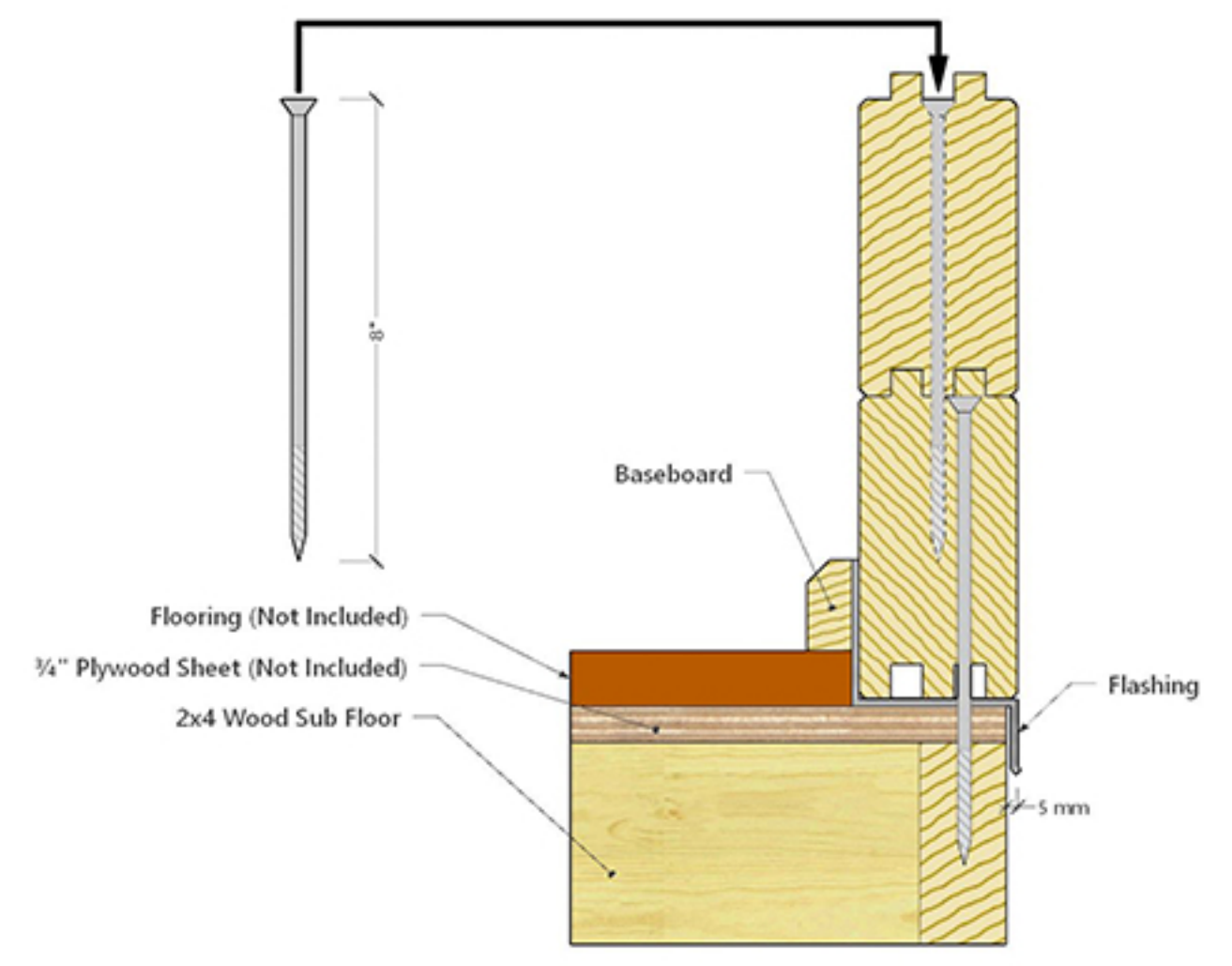

Foundation Connection Sub Floor

IN-HOUSE DRAWINGS ONLY - SUBJECT TO CHANGE - FINAL ENGINEERING REQUIRED