

# Billings 160 40 (384x384)

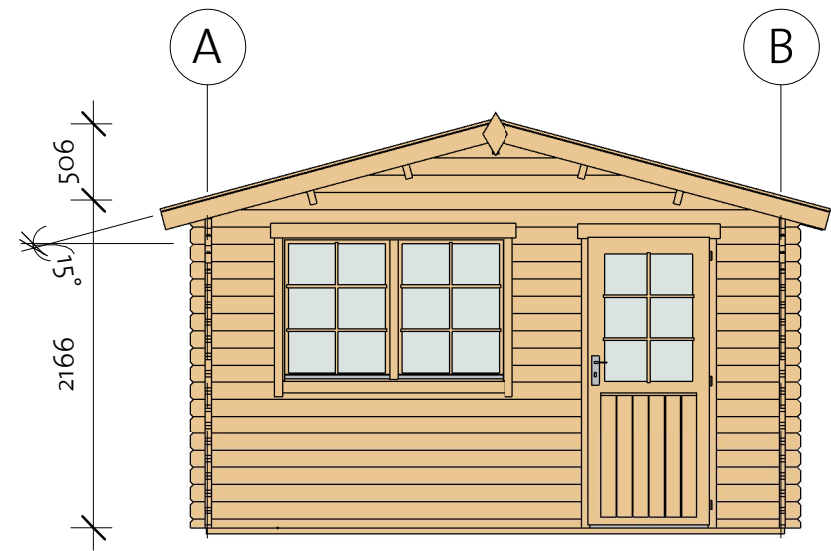

# Billings 160 40 (384x384)

Foundation

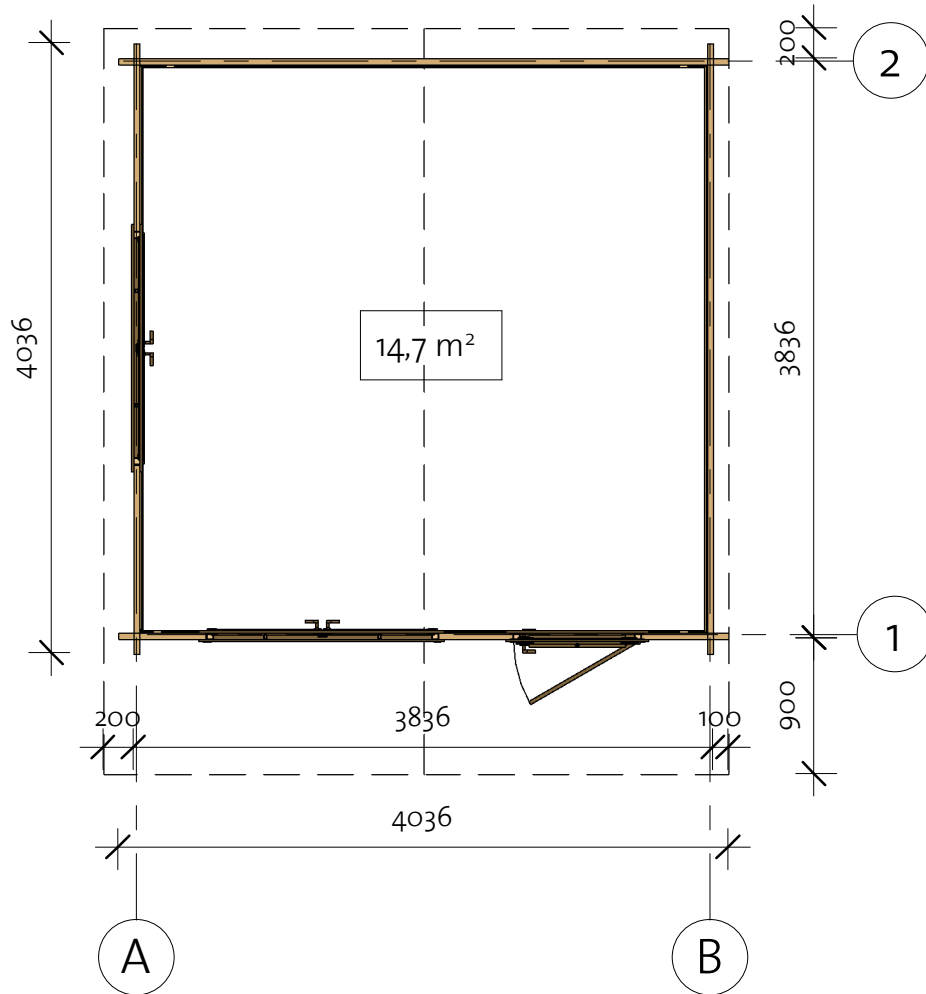
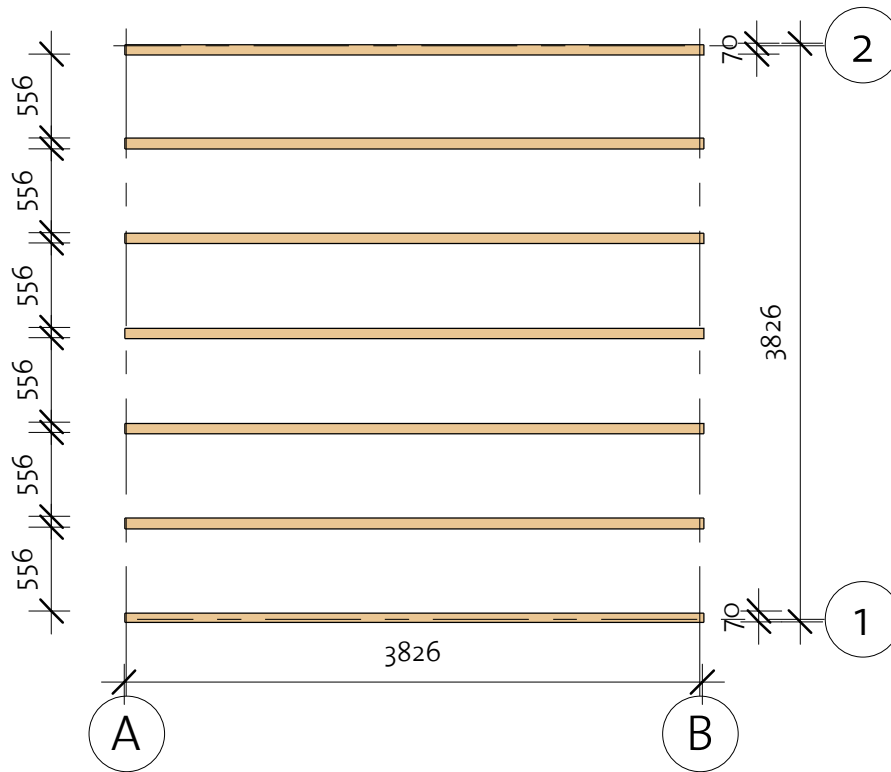

Impregnated foundation beams				
Mark	Type	Profile	Count	Length

IFB	IFB 70x40		7	3826
-----	--------------	---	---	------

# Billings 160 40 (384x384)

Floor Plan

① Baseboard

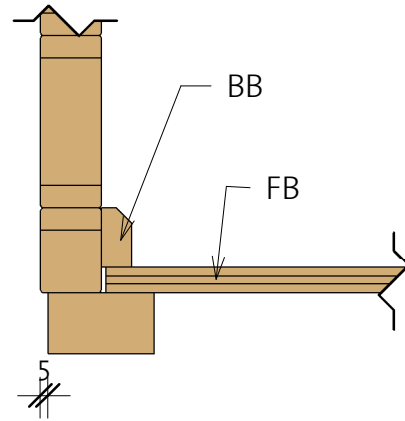



40/100

3756

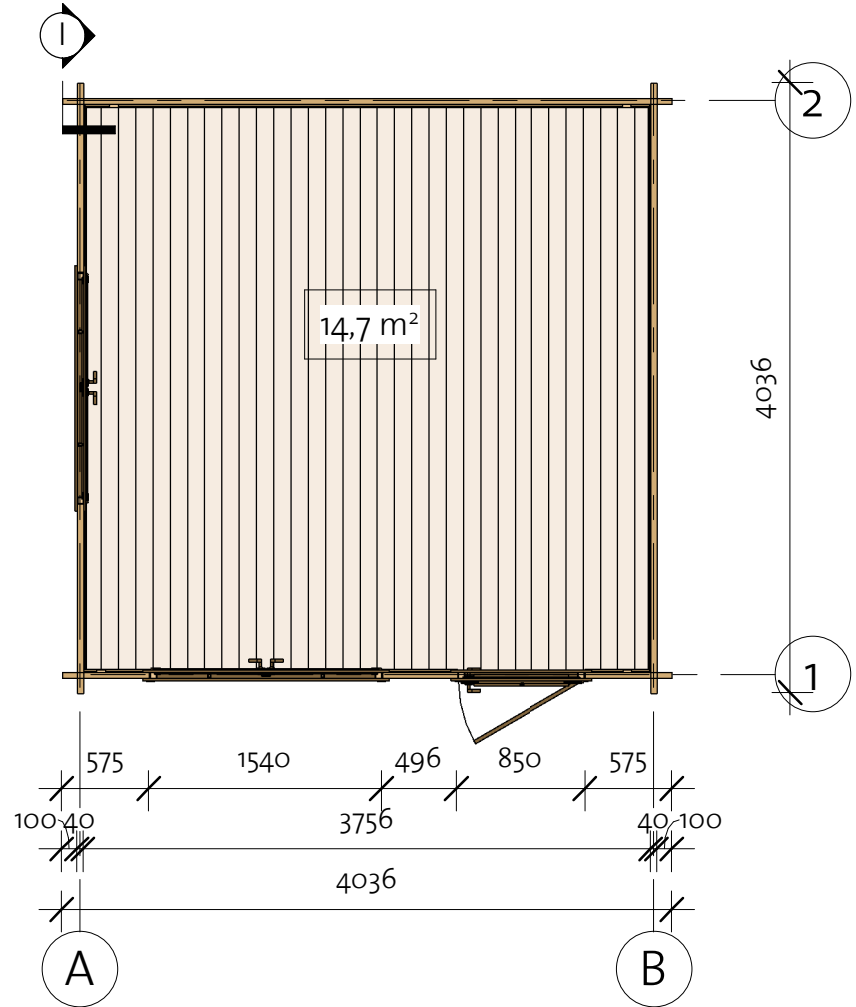
100/40



Floor Schedule				
Mark	Type	Profile	Count	Length
FB	FB 17x114		34	3750
BB1	BB 20x40		4	3900

# Billings 160 40 (384x384)

Wall 1

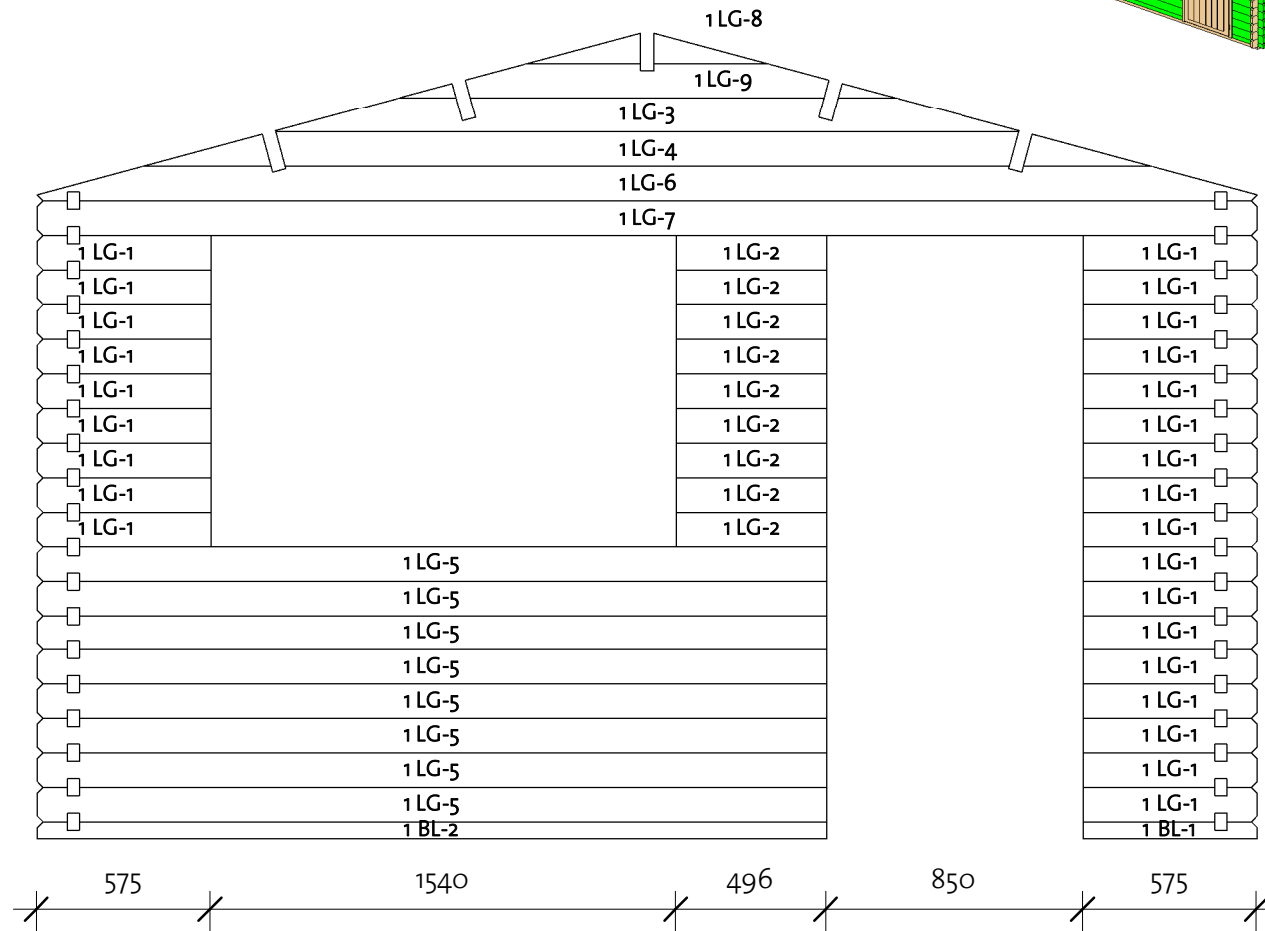
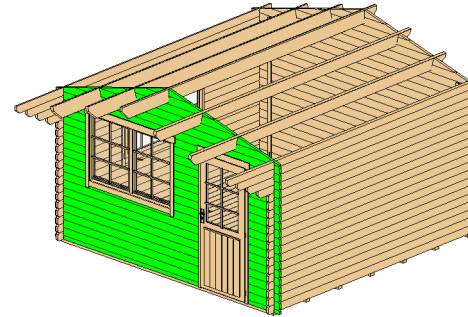

Wall 1			
Mark	Profile	Count	Cut Length

1BL-1	40X57	1	575
1BL-2	40X57	1	2611
1LG-1	40X114	26	575
1LG-2	40X114	9	496
1LG-3*	40X114	1	2461
1LG-4*	40X114	1	3333
1LG-5	40X114	8	2611
1LG-6*	40X114	1	4035
1LG-7	40X114	1	4036
1LG-8*	40X114	1	796
1LG-9*	40X114	1	1642

\* Gable - delivered premounted

Log Profile Wall 1	
Profile	Profile

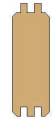
40X57	
40X114	

# Billings 160 40 (384x384)

Wall 2

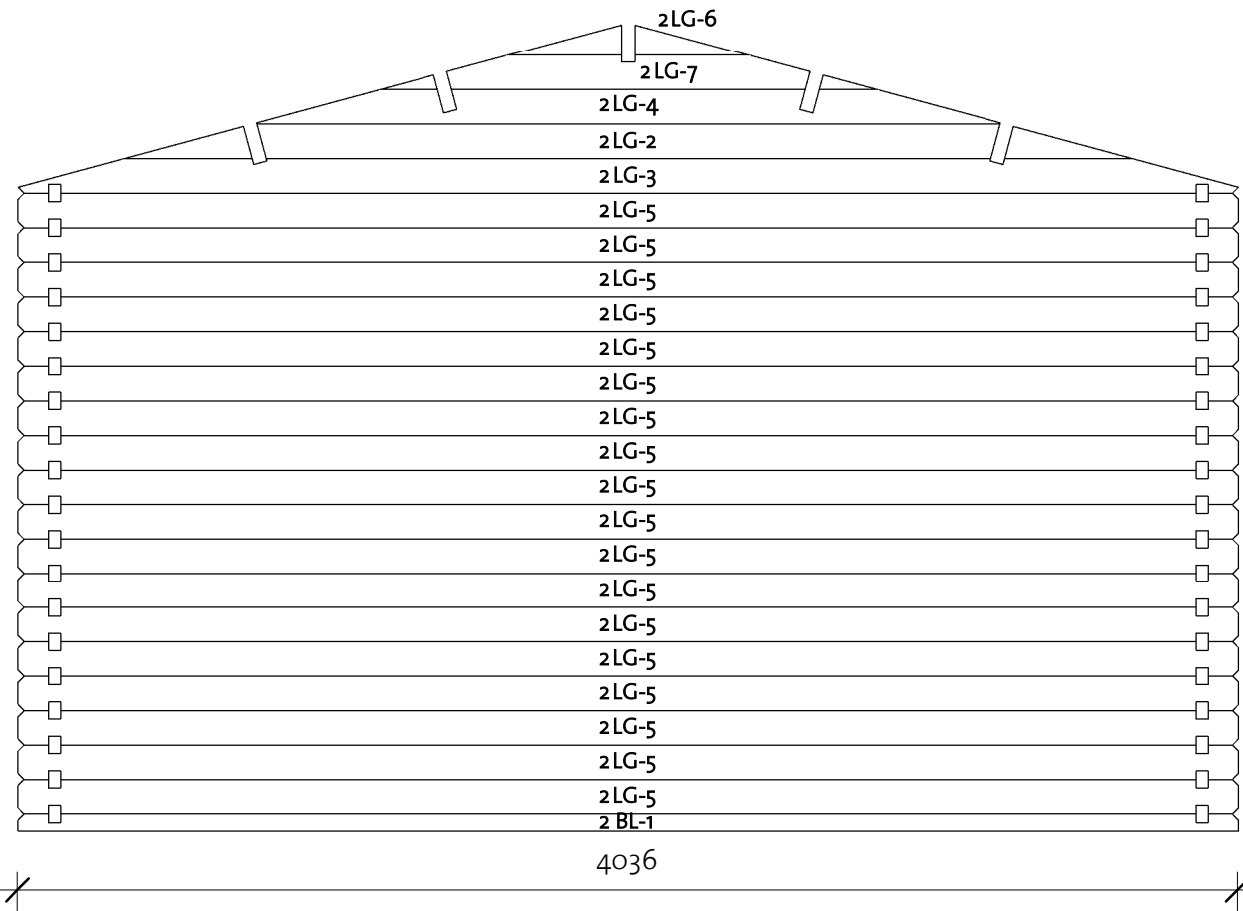
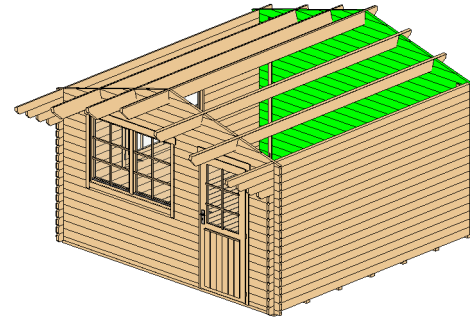



Wall 2			
Mark	Profile	Count	Cut Length

2BL-1	40X57	1	4036
2LG-2*	40X114	1	3333
2LG-3*	40X114	1	4035
2LG-4*	40X114	1	2461
2LG-5	40X114	18	4036
2LG-6*	40X114	1	796
2LG-7*	40X114	1	1642

\* Gable - delivered premounted

Log Profile Wall 2	
Profile	Profile

40X57	
40X114	

# Billings 160 40 (384x384)

Wall A

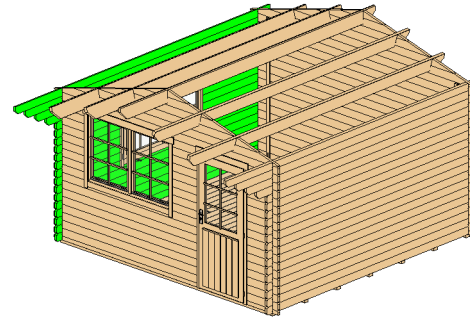

Wall A			
Mark	Profile	Count	Cut Length

ALG-1	40X114	7	4036
ALG-2	40X114	1	1448
ALG-3	40X114	1	4436
ALG-4	40X114	1	4636
ALG-5	40X114	17	1248
ATL-1	40X114	1	4936

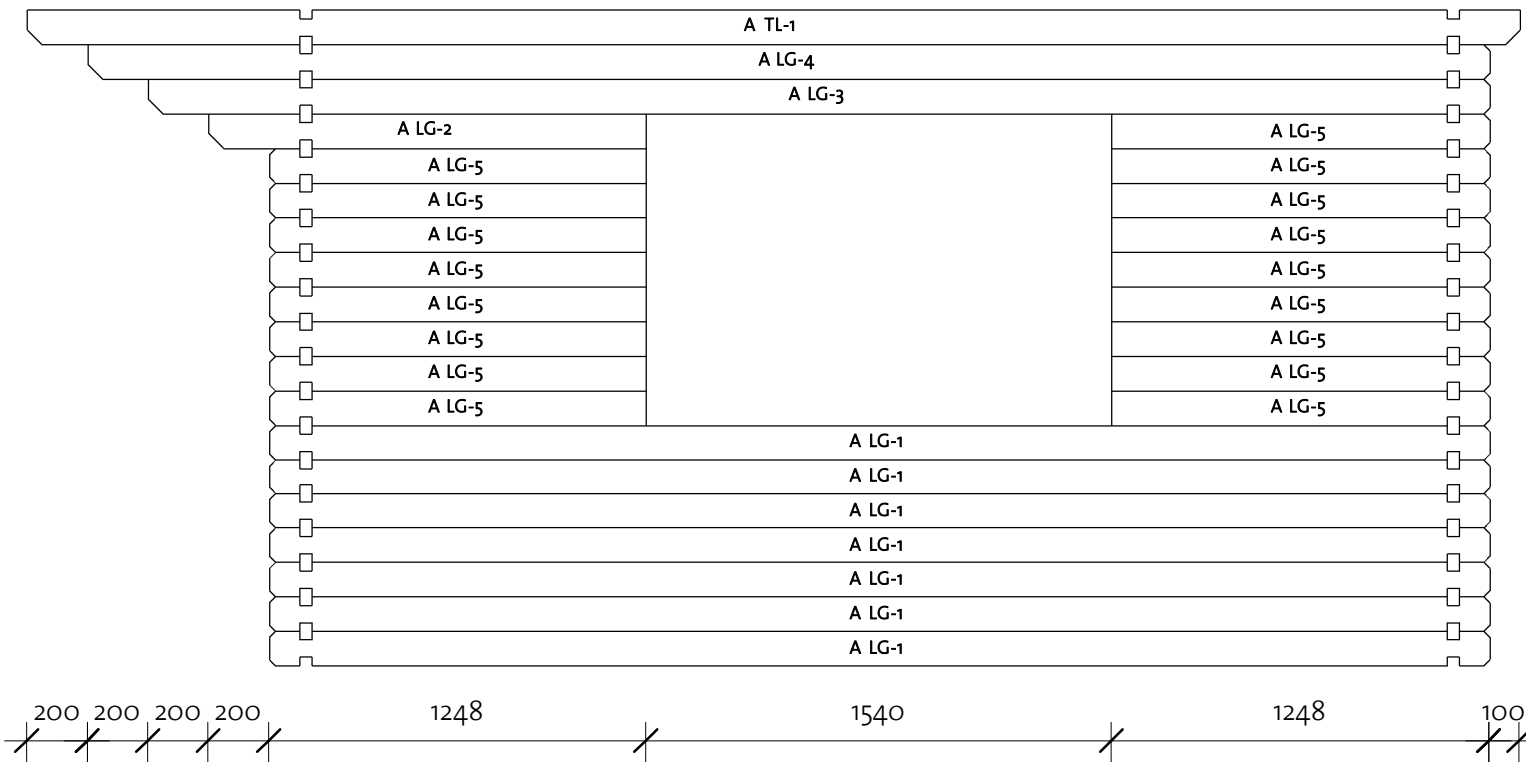

Log Profile Wall A	
Profile	Profile

40X114	
40X114	

# Billings 160 40 (384x384)

Wall B

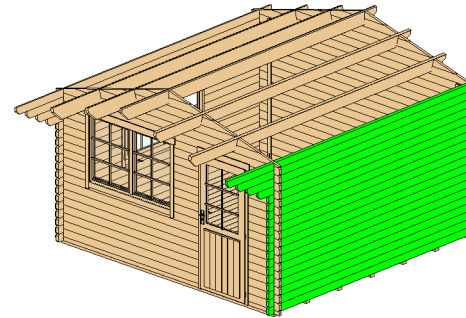

Wall B			
Mark	Profile	Count	Cut Length

BLG-1	40X114	15	4036
BLG-2	40X114	1	4236
BLG-3	40X114	1	4436
BLG-4	40X114	1	4636
BTL-1	40X114	1	4936

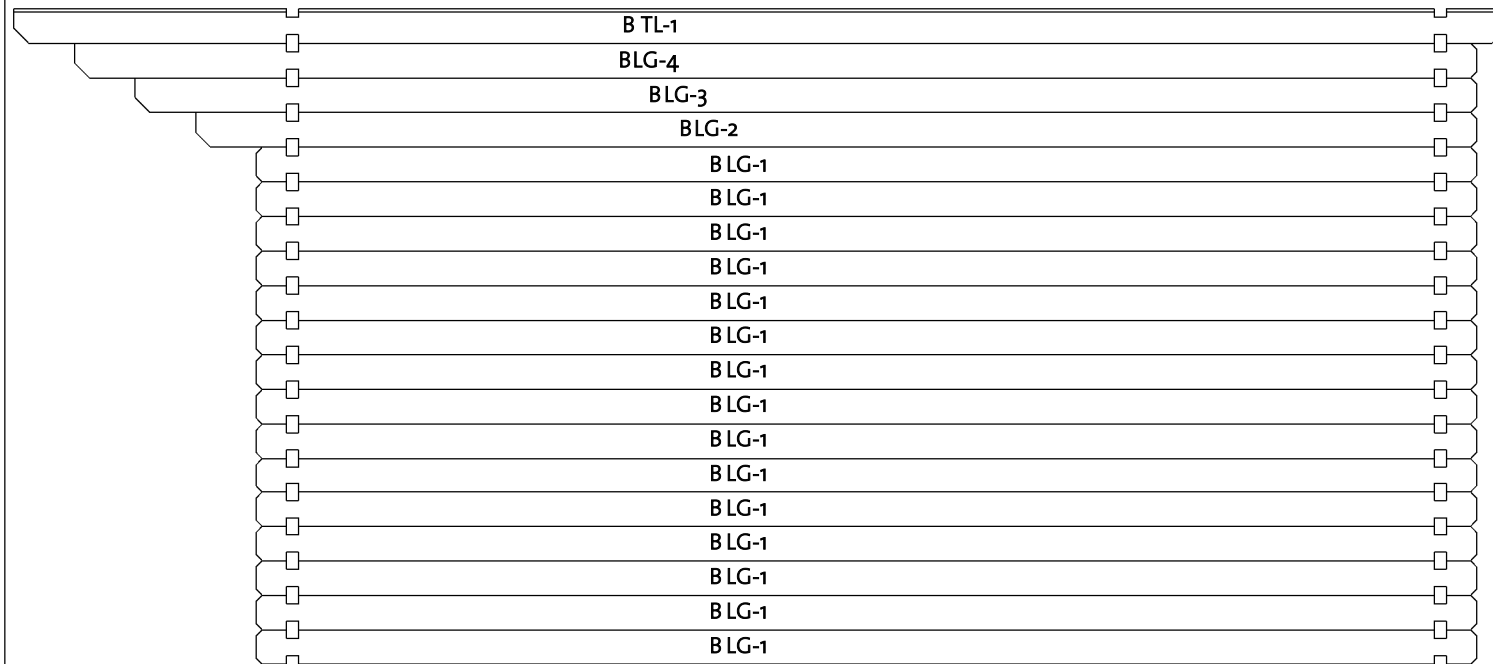





Log Profile Wall B	
Profile	Profile

40X114	
40X114	

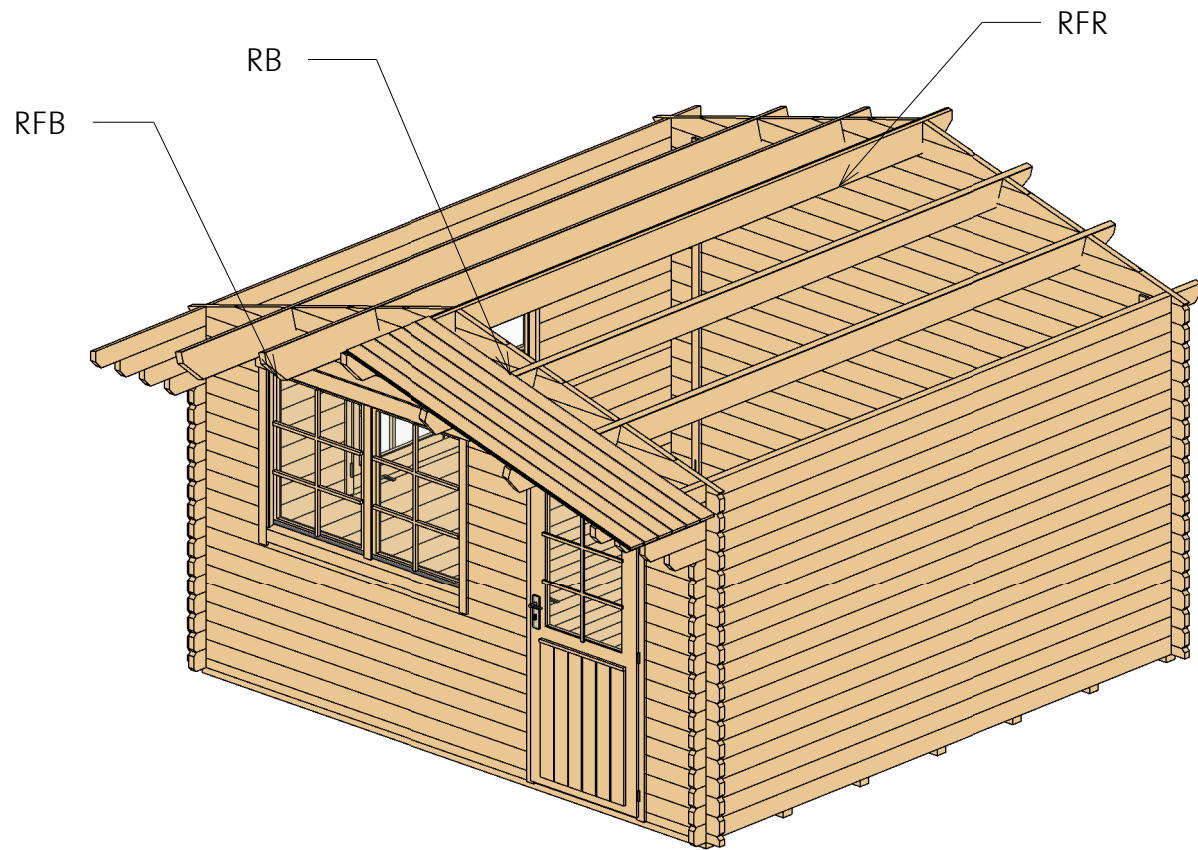
# Billings 160 40 (384x384)

Roof 1



Roof				
Mark	Type	Profile	Count	Length
RFR	Ridge 45x195		1	4936
RFB	Beam 45x195		4	4936
RB	17x114		88	2240



# Billings 160 40 (384x384)

Roof 2

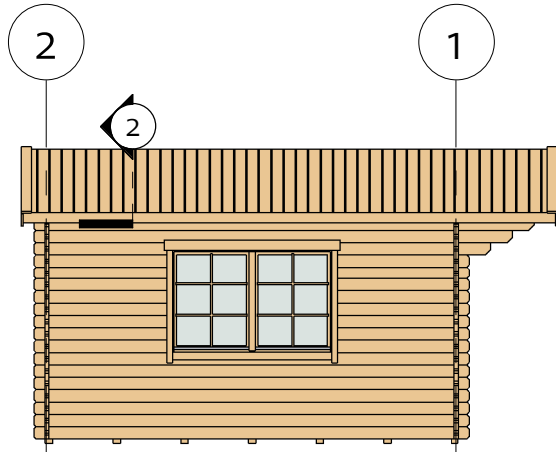

② Facia

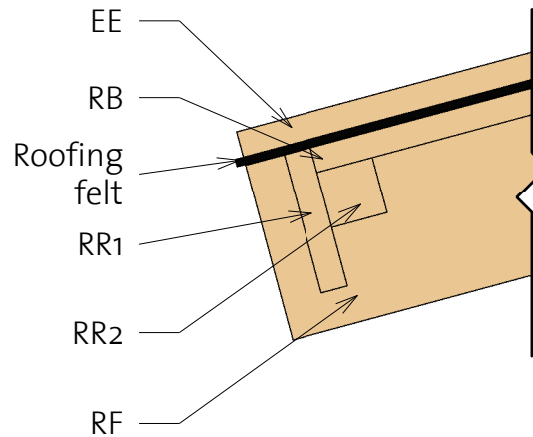

③ Roof Reinforcement

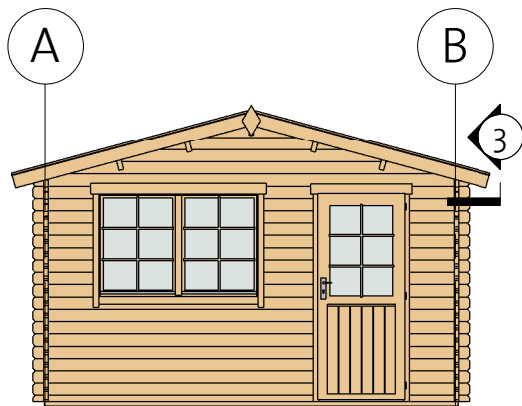
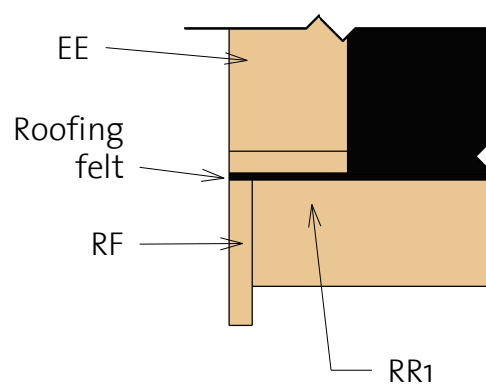

Fascia Schedule				
Mark	Type	Profile	Count	Length

EE	Eave Edging 18x95		4	2290
RF	Roof Fascia 18x120		4	2290
RR1	Roof reinforcement 18x95		2	4936
RR2	Roof reinforcement 38x38		2	4936

# Billings 160 40 (384x384)

Extras

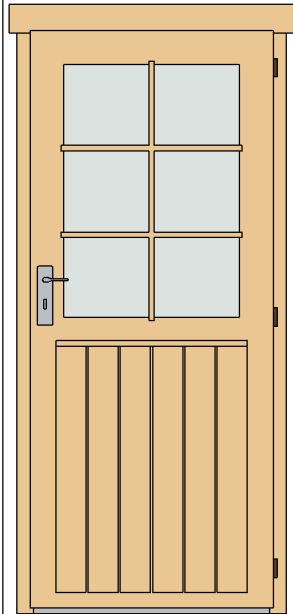

Door Schedule				
Mark	Type	Width	Height	Count
CD4R	Classic door 4 right	840	1955	1
DCB6	Door Crossbar 6	--	--	1

Window Schedule				
Mark	Type	Width	Height	Count
CDW1	Classic double window 1	1530	990	2
WCB6	Windows Crossbar 6	--	--	4

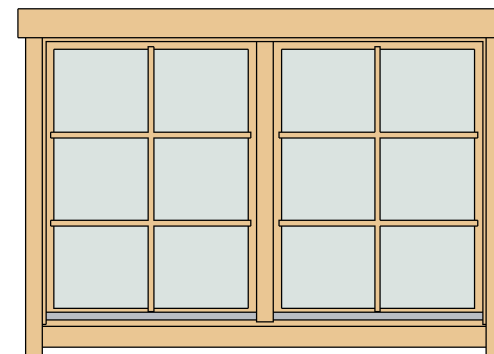

Fasteners & Extras		
Name	Type	Count

Hitblock	300-400 mm	
Bolts	M8x70	12
Screws	5,0 x 70	15
Nails	1,4 x 40	30
Screws	6,0 x 140	30
Screws	4,0 x 40	700

Family	Count
Romb	2

Type	Count	Length
Windboard 18x40	4	2200

92309164\_230926





# Billings 160 40 (384x384)

## List of all items 1



### Impregnated foundation beams

Mark	Type	Profile	Count	Length
IFB	IFB 70x40		7	3826





### Floor Schedule

Mark	Type	Profile	Count	Length
FB	FB 17x114		34	3750
BB1	BB 20x40		4	3900

### Roof

Mark	Type	Profile	Count	Length
RFR	Ridge 45x195		1	4936
RFB	Beam 45x195		4	4936
RB	17x114		88	2240

### Fascia Schedule

Mark	Type	Profile	Count	Length
EE	Eave Edging 18x95		4	2290
RF	Roof Fascia 18x120		4	2290
RR1	Roof reinforcement 18x95		2	4936
RR2	Roof reinforcement 38x38		2	4936

# Billings 160 40 (384x384)

## List of all items 2

Wall 1			
Mark	Profile	Count	Cut Length

1BL-1	40X57	1	575
1BL-2	40X57	1	2611
1LG-1	40X114	26	575
1LG-2	40X114	9	496
1LG-3*	40X114	1	2461
1LG-4*	40X114	1	3333
1LG-5	40X114	8	2611
1LG-6*	40X114	1	4035
1LG-7	40X114	1	4036
1LG-8*	40X114	1	796
1LG-9*	40X114	1	1642

Wall 2			
Mark	Profile	Count	Cut Length

2BL-1	40X57	1	4036
2LG-2*	40X114	1	3333
2LG-3*	40X114	1	4035
2LG-4*	40X114	1	2461
2LG-5	40X114	18	4036
2LG-6*	40X114	1	796
2LG-7*	40X114	1	1642

\* Gable - delivered premounted



Wall A			
Mark	Profile	Count	Cut Length

ALG-1	40X114	7	4036
ALG-2	40X114	1	1448
ALG-3	40X114	1	4436
ALG-4	40X114	1	4636
ALG-5	40X114	17	1248
ATL-1	40X114	1	4936

Wall B			
Mark	Profile	Count	Cut Length

BLG-1	40X114	15	4036
BLG-2	40X114	1	4236
BLG-3	40X114	1	4436
BLG-4	40X114	1	4636
BTL-1	40X114	1	4936

Log Profiles1	
Profile	Profile

40X57	
40X114	

Log Profiles1	
Profile	Profile

40X114	
--------	---