

# Sabrina 40 (570x380)

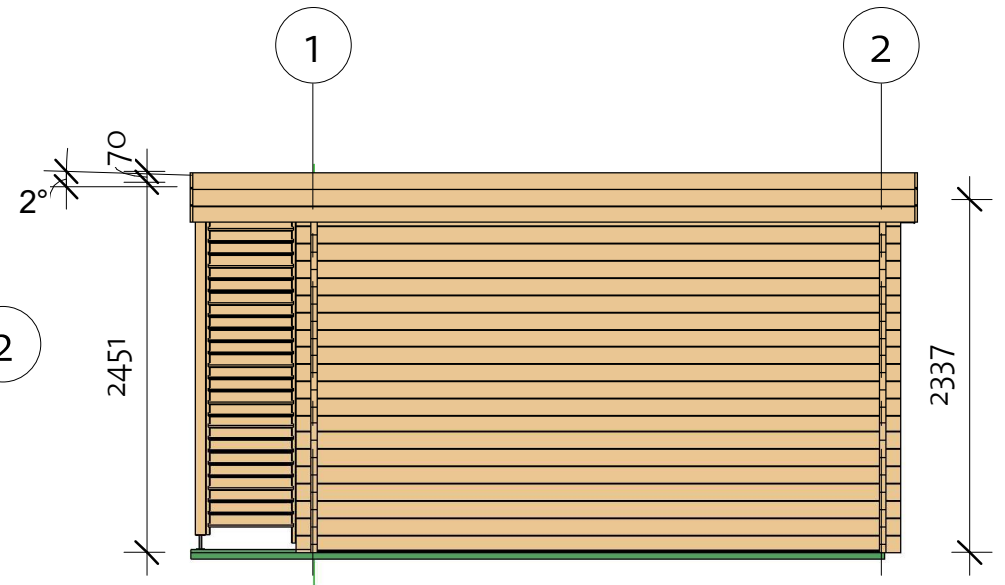

# Sabrina 40 (570x380)

Foundation

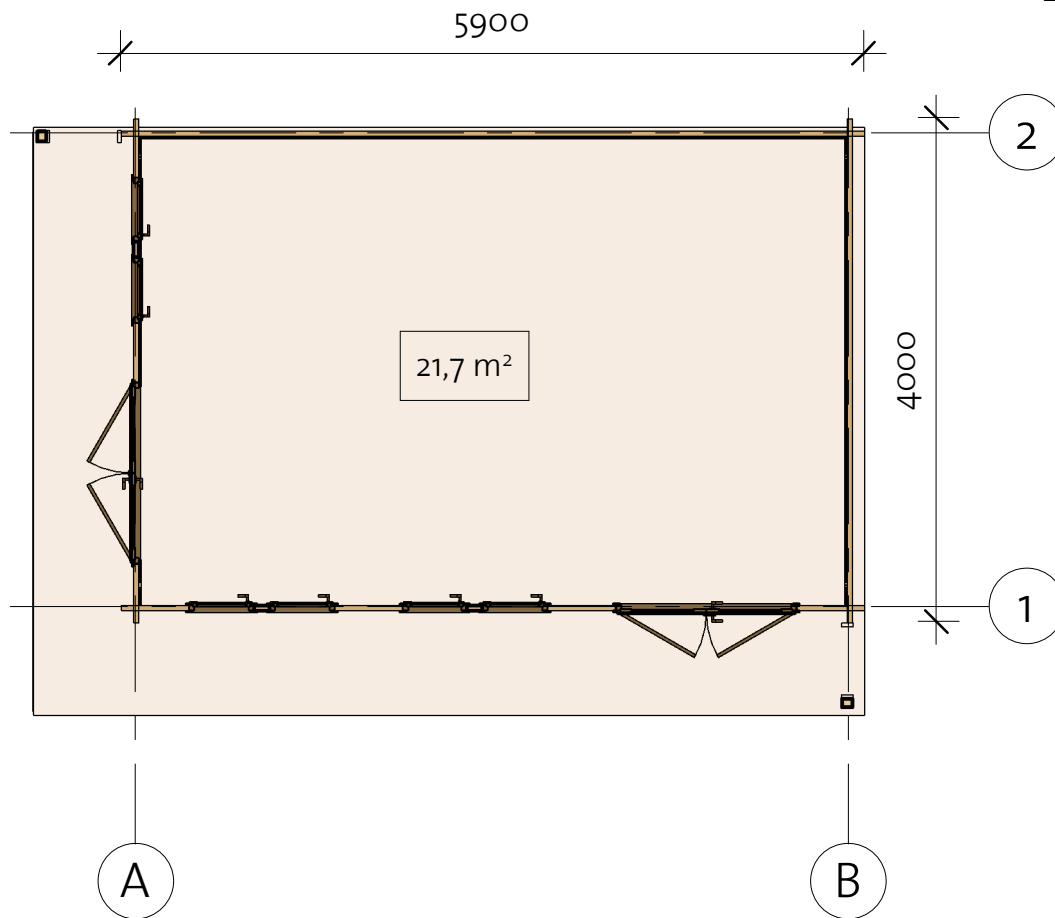
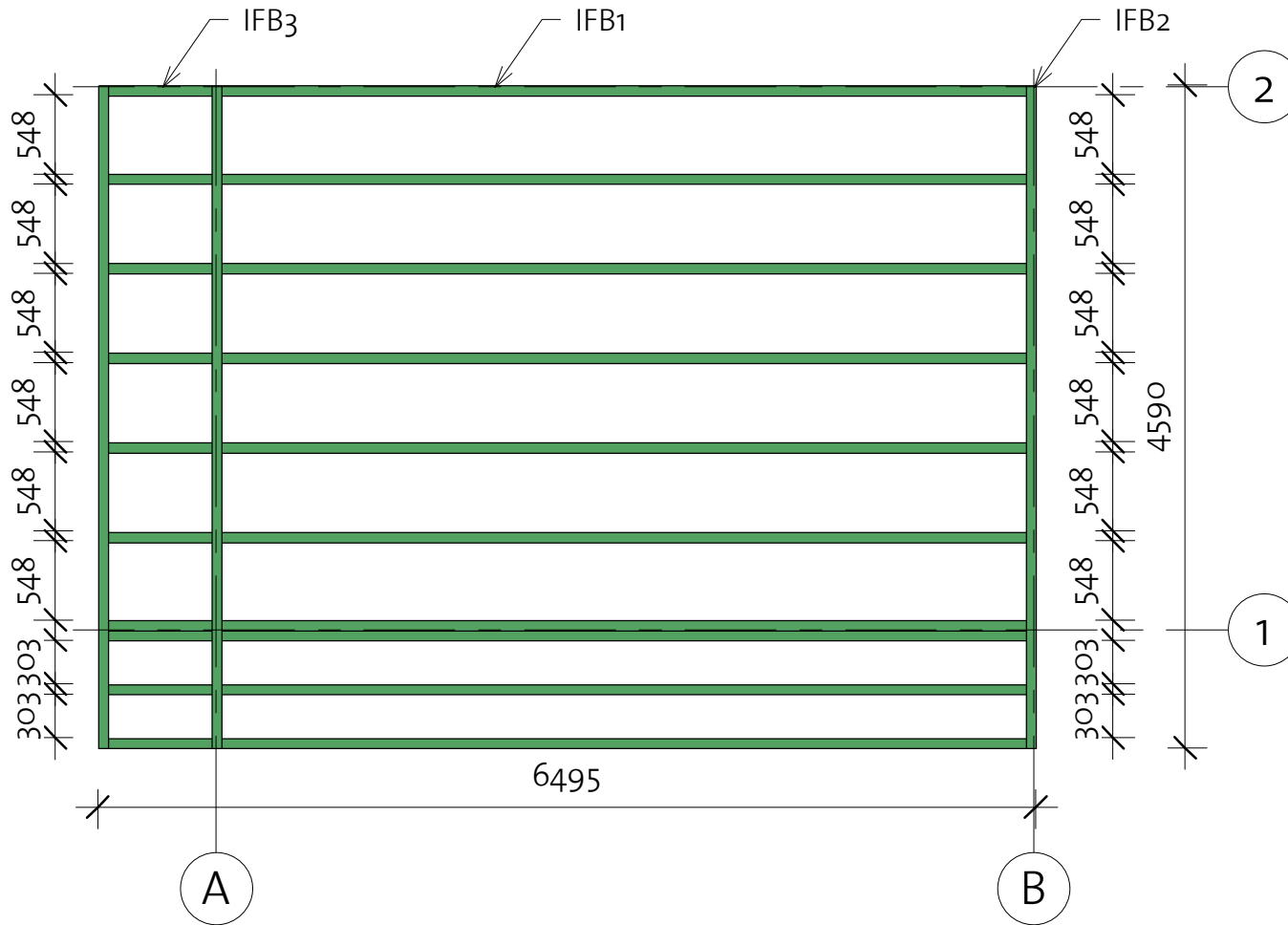

| Impregnated foundation beams |      |         |       |        |
|------------------------------|------|---------|-------|--------|
| Mark                         | Type | Profile | Count | Length |

|      |              |   |    |      |
|------|--------------|---|----|------|
| IFB1 | IFB<br>70x40 |  | 10 | 5570 |
| IFB2 | IFB<br>70x40 |   | 3  | 4590 |
| IFB3 | IFB<br>70x40 |   | 10 | 715  |

# Sabrina 40 (570x380)

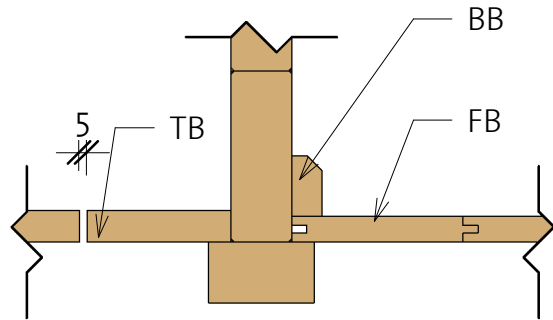

Floor Plan

① Baseboard



Floor Schedule

| Mark | Type | Profile | Count | Length |
|------|------|---------|-------|--------|
|------|------|---------|-------|--------|

|     |           |   |    |      |
|-----|-----------|---|----|------|
| FB  | FB 17x114 |    | 51 | 3714 |
| TB1 | TB 21x95  |  | 8  | 4590 |
| TB2 | TB 21x95  |   | 58 | 795  |

|     |          |   |      |   |
|-----|----------|---|------|---|
| BB1 | BB 20x40 |  | 5700 | 2 |
| BB2 | BB 20x40 |   | 3800 | 2 |

220421

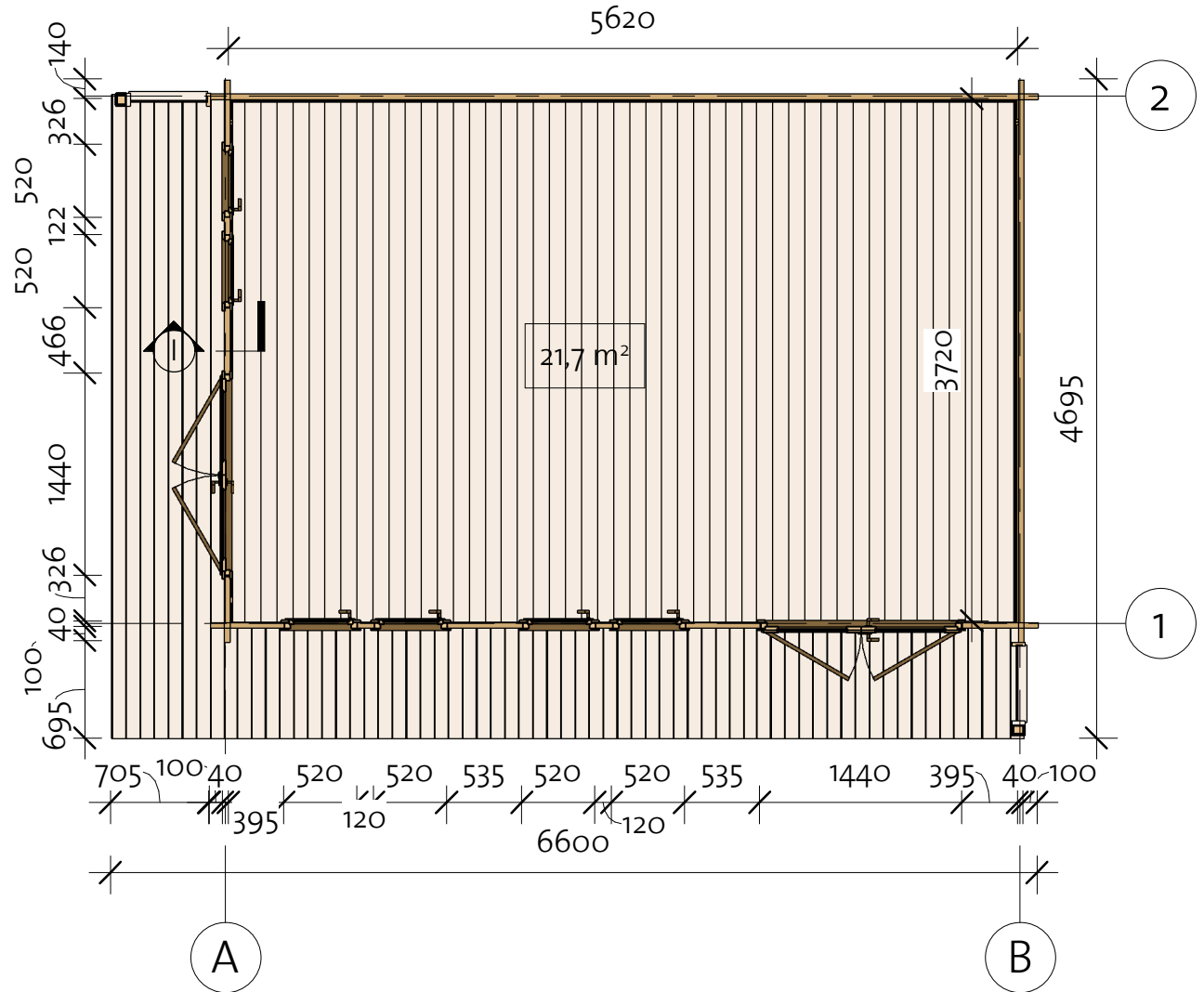

# Sabrina 40 (570x380)

Wall 1

| Log Profile Wall 1 |         |
|--------------------|---------|
| Profile            | Profile |

|       |   |
|-------|---|
| 40X57 |  |
|-------|---|

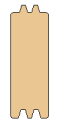
|        |   |
|--------|---|
| 40X114 |  |
|--------|---|

| Log Profile Wall 1 |         |
|--------------------|---------|
| Profile            | Profile |

|        |   |
|--------|---|
| 40X114 |  |
|--------|---|

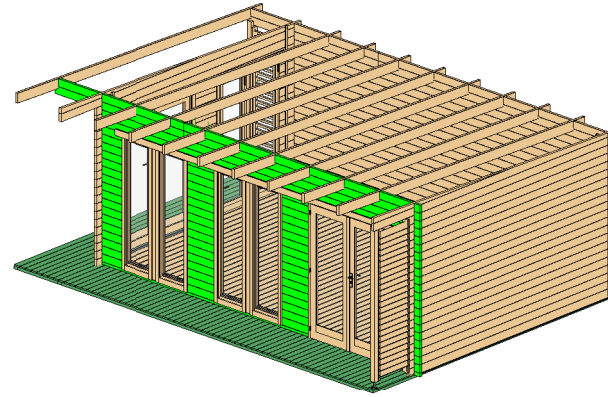

Wall 1

| Mark | Profile | Count | Cut Length |
|------|---------|-------|------------|
|------|---------|-------|------------|

|       |        |    |      |
|-------|--------|----|------|
| 1BL-1 | 40X57  | 1  | 535  |
| 1BL-2 | 40X57  | 1  | 3925 |
| 1LG-1 | 40X114 | 1  | 5900 |
| 1LG-2 | 40X114 | 34 | 535  |
| 1LG-3 | 40X114 | 34 | 535  |
| 1LG-4 | 40X114 | 1  | 4250 |
| 1LG-5 | 40X114 | 1  | 2351 |
| 1LG-6 | 40X114 | 1  | 5900 |
| 1TL-1 | 40X114 | 1  | 4250 |
| 1TL-2 | 40X114 | 1  | 2333 |

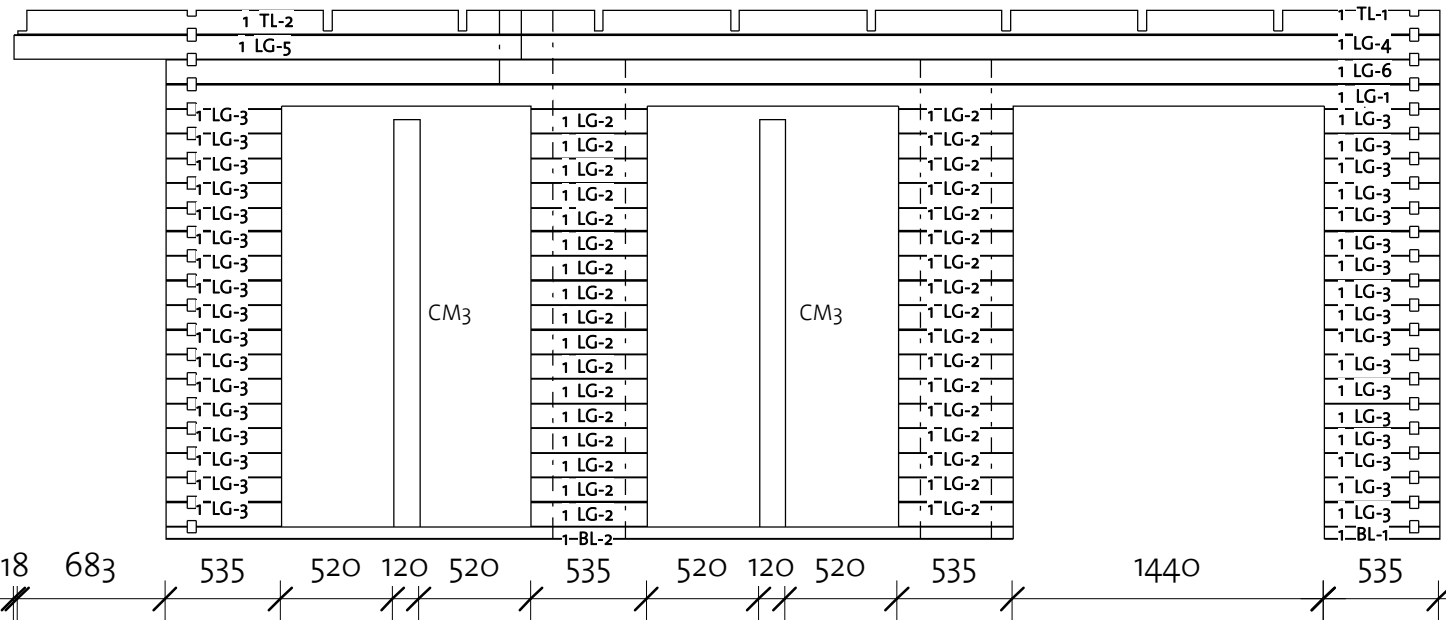

Columns Wall 1



| Mark | Profile | Count | Length |
|------|---------|-------|--------|
|------|---------|-------|--------|

|     |             |   |      |
|-----|-------------|---|------|
| CM3 | Post 40X120 | 2 | 1890 |
|-----|-------------|---|------|

# Sabrina 40 (570x380)

Wall 2

| Log Profile Wall 2 |         |
|--------------------|---------|
| Profile            | Profile |

|        |   |
|--------|---|
| 40x57  |  |
| 40x114 |  |

| Log Profile Wall 2 |         |
|--------------------|---------|
| Profile            | Profile |

|        |   |
|--------|---|
| 40x114 |  |
|--------|---|

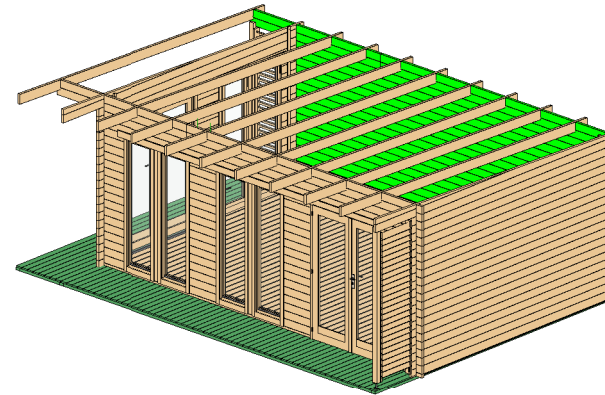

| Wall 2 |         |       |            |
|--------|---------|-------|------------|
| Mark   | Profile | Count | Cut Length |

|       |        |    |      |
|-------|--------|----|------|
| 2BL-1 | 40x57  | 1  | 5900 |
| 2LG-1 | 40x114 | 1  | 2351 |
| 2LG-2 | 40x114 | 17 | 5900 |
| 2LG-3 | 40x114 | 1  | 4250 |
| 2LG-4 | 40x114 | 1  | 5900 |
| 2TL-1 | 40x114 | 1  | 4250 |
| 2TL-2 | 40x114 | 1  | 2333 |

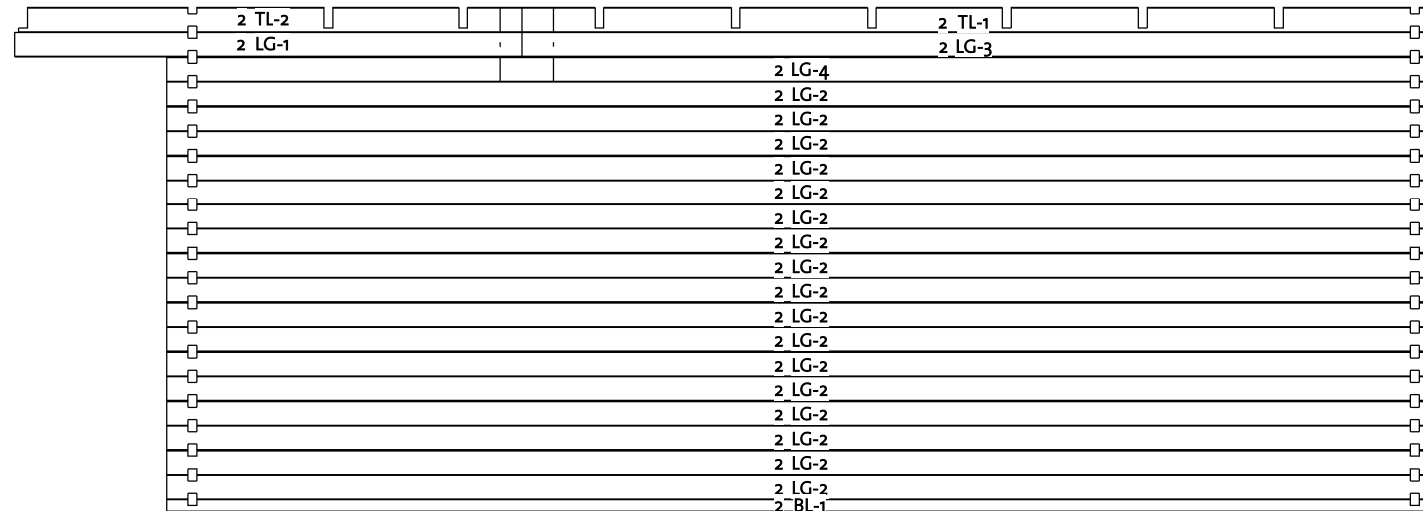

18 683

5900

220421

# Sabrina 40 (570x380)

Wall A

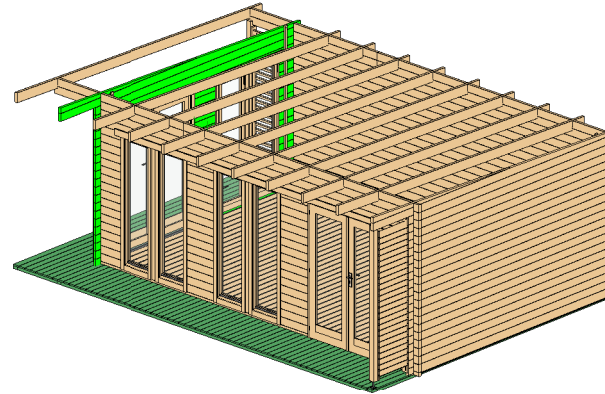

| Wall A |         |       |            |
|--------|---------|-------|------------|
| Mark   | Profile | Count | Cut Length |
| ALG-1  | 40X114  | 1     | 4000       |
| ALG-2  | 40X114  | 33    | 466        |
| ALG-3  | 40X114  | 16    | 468        |
| ALG-4* | 40X114  | 1     | 2661       |
| ALG-5  | 40X114  | 2     | 4000       |
| ALG-6* | 40X114  | 1     | 4681       |
| ALG-7  | 40X114  | 1     | 2094       |

\* Gable - delivered premounted

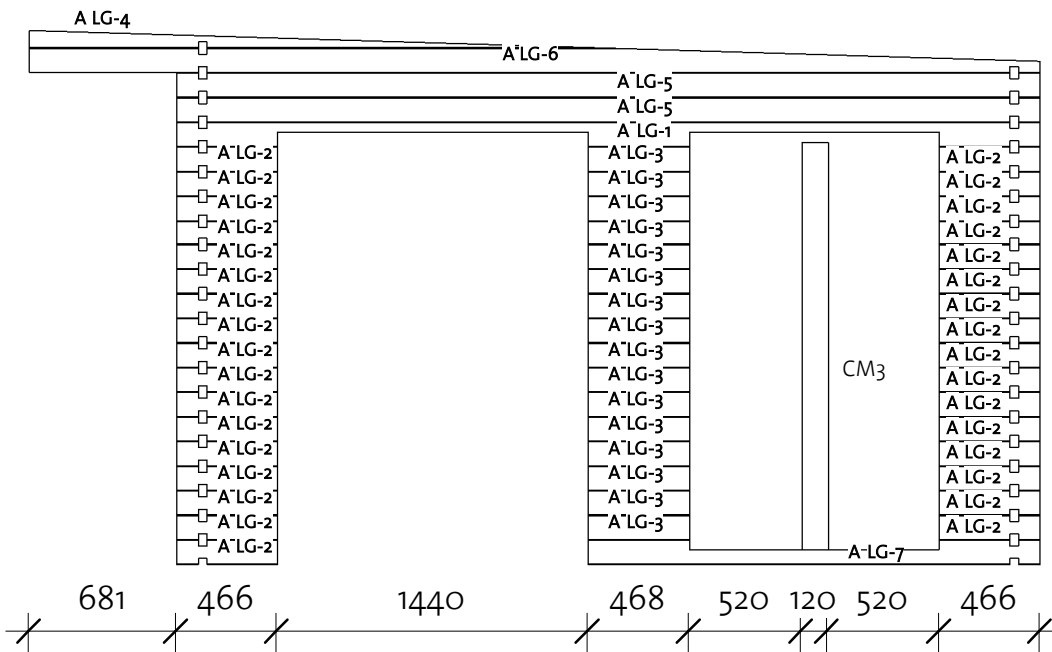

| Columns Wall A |             |       |        |
|----------------|-------------|-------|--------|
| Mark           | Profile     | Count | Length |
| CM3            | Post 40x120 | 1     | 1890   |

| Log Profile Wall A |         |
|--------------------|---------|
| Profile            | Profile |

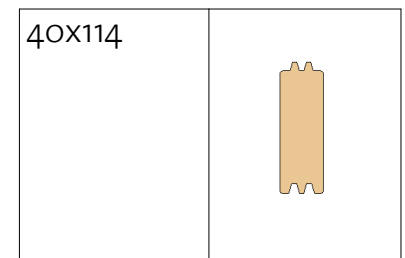

# Sabrina 40 (570x380)

Wall B

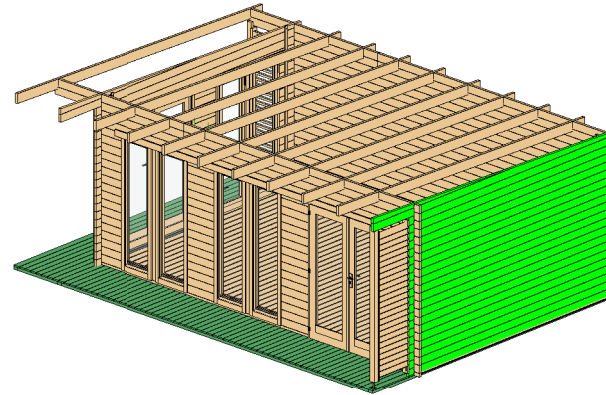

| Wall B |         |       |            |
|--------|---------|-------|------------|
| Mark   | Profile | Count | Cut Length |
| BLG-1* | 40X114  | 1     | 2661       |
| BLG-2  | 40X114  | 20    | 4000       |
| BLG-3* | 40X114  | 1     | 4681       |

\* Gable - delivered premounted

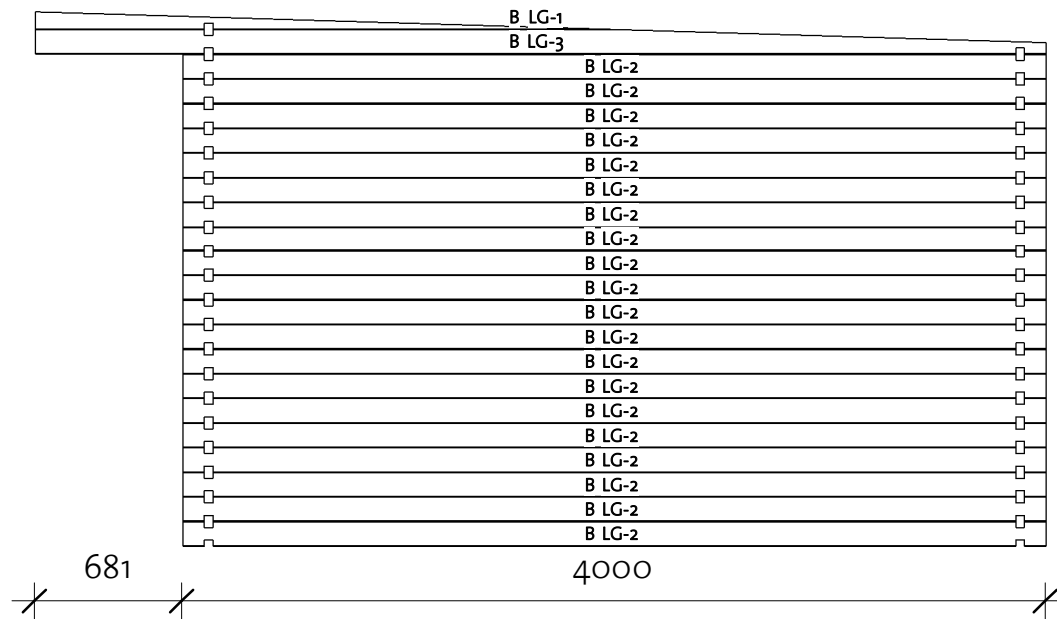

| Log Profile Wall B |         |
|--------------------|---------|
| Profile            | Profile |



|        |  |
|--------|--|
| 40X114 |  |
|--------|--|

# Sabrina 40 (570x380)

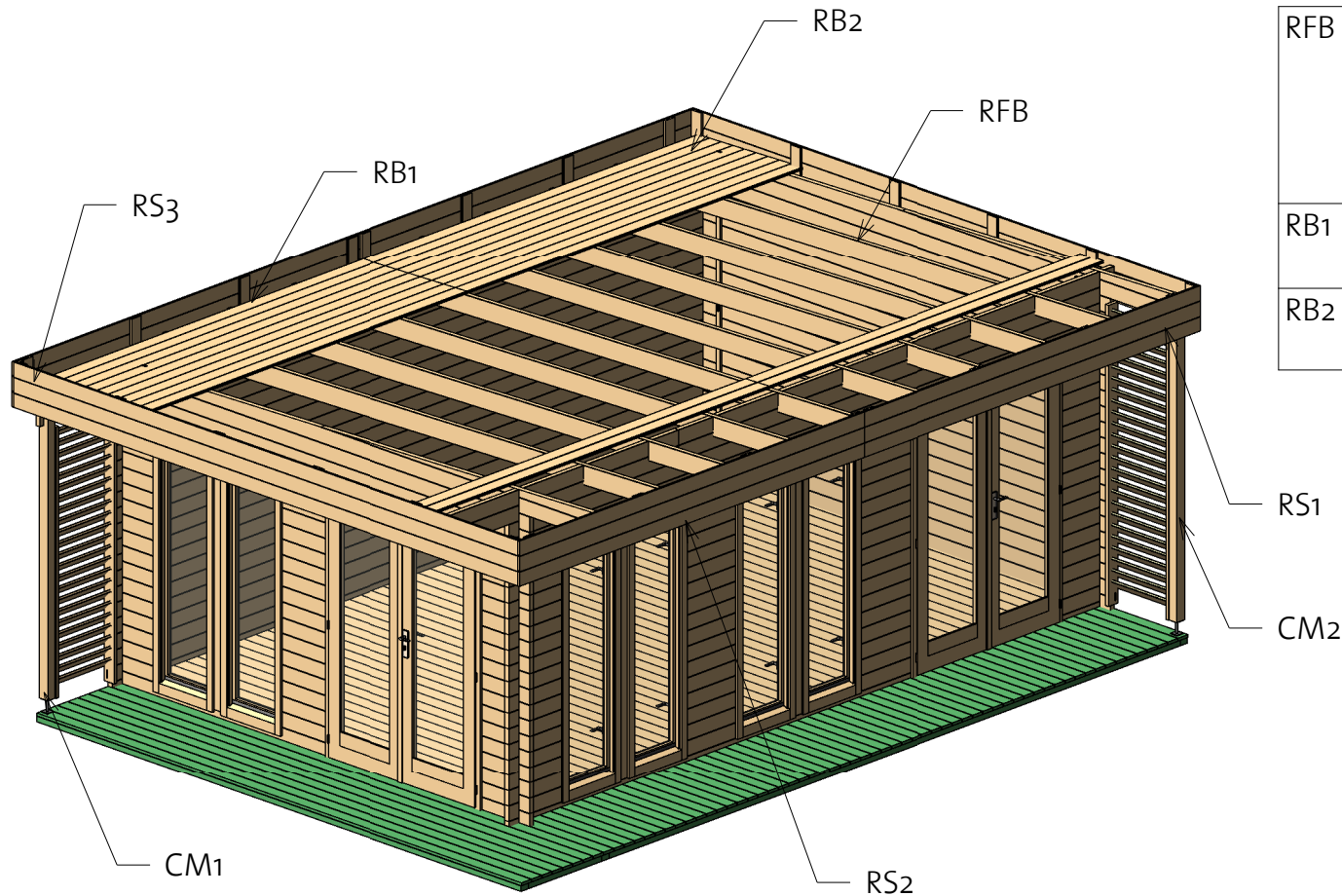
Roof 1



| Roof |      |         |       |        |
|------|------|---------|-------|--------|
| Mark | Type | Profile | Count | Length |

|     |                     |   |    |      |
|-----|---------------------|---|----|------|
| RFB | Beam<br>40x143      |  | 9  | 4779 |
| RB1 | Roofboard<br>17x114 |  | 42 | 3335 |
| RB2 | Roofboard<br>17x114 |   | 42 | 3265 |

## Roof Side Schedule

| Type | Length | Count |
|------|--------|-------|
|------|--------|-------|

|     |      |   |
|-----|------|---|
| RS1 | 3282 | 2 |
| RS2 | 3354 | 2 |
| RS3 | 4772 | 2 |

## Columns

| Mark | Profile | Count | Length |
|------|---------|-------|--------|
|------|---------|-------|--------|



|     |            |   |      |
|-----|------------|---|------|
| CM1 | Post 80x70 | 1 | 2045 |
| CM2 | Post 80x70 | 1 | 2216 |



# Sabrina 40 (570x380)

Roof 2

| Fascia Schedule |      |         |       |        |
|-----------------|------|---------|-------|--------|
| Mark            | Type | Profile | Count | Length |

|     |                      |   |   |      |
|-----|----------------------|---|---|------|
| EE1 | Eave Edging<br>18x95 |  | 2 | 3303 |
| EE2 | Eave Edging<br>18x95 |  | 2 | 4685 |

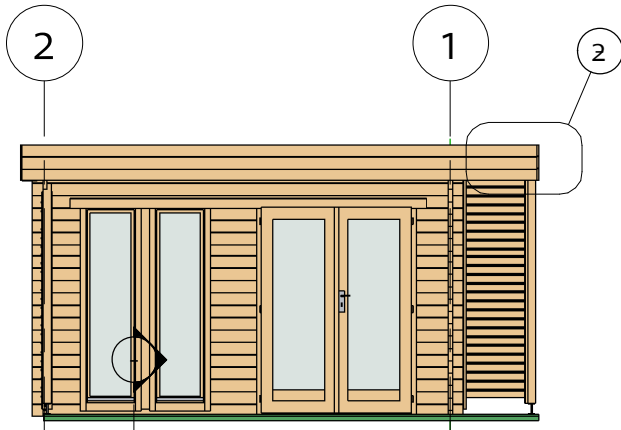

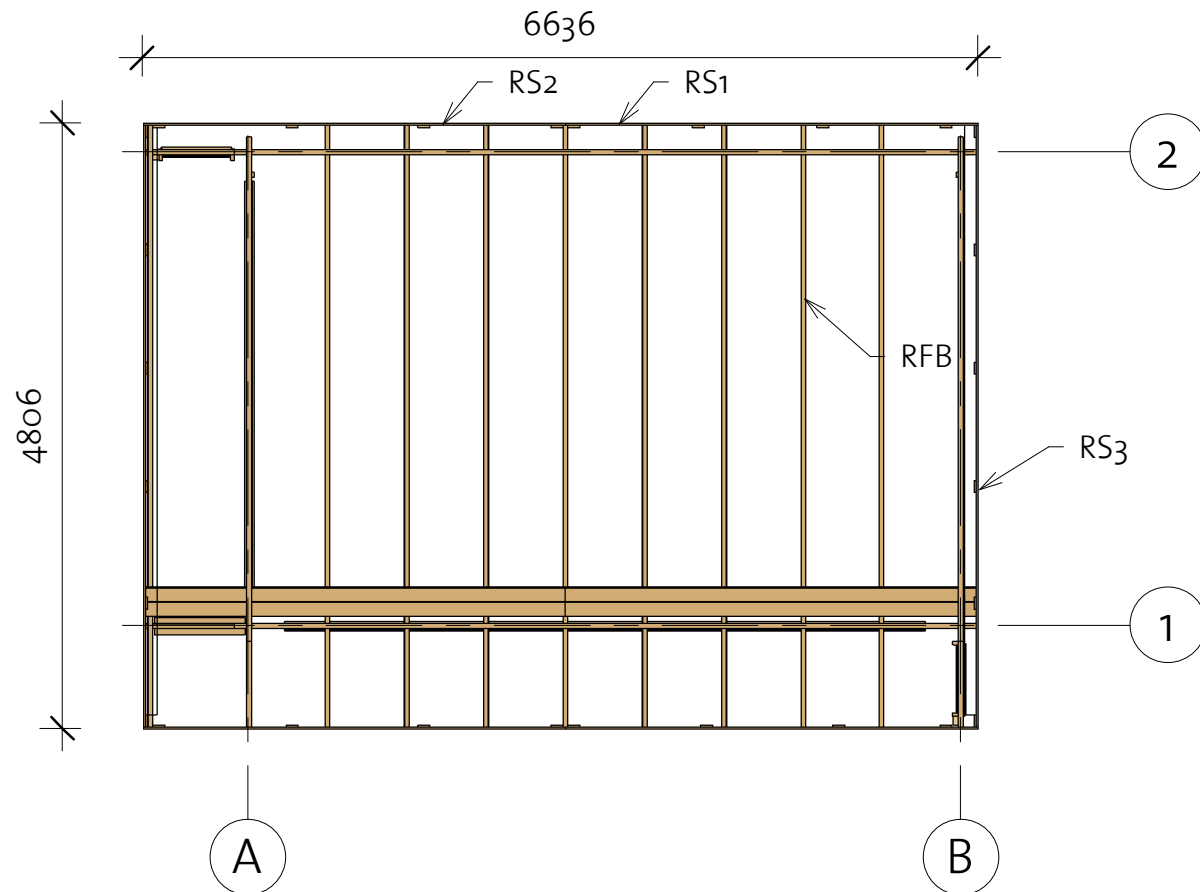
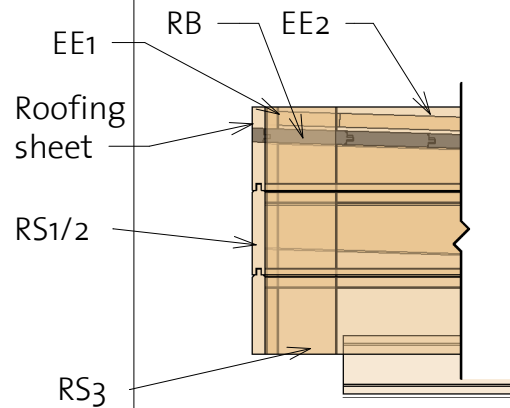

② Roof callout

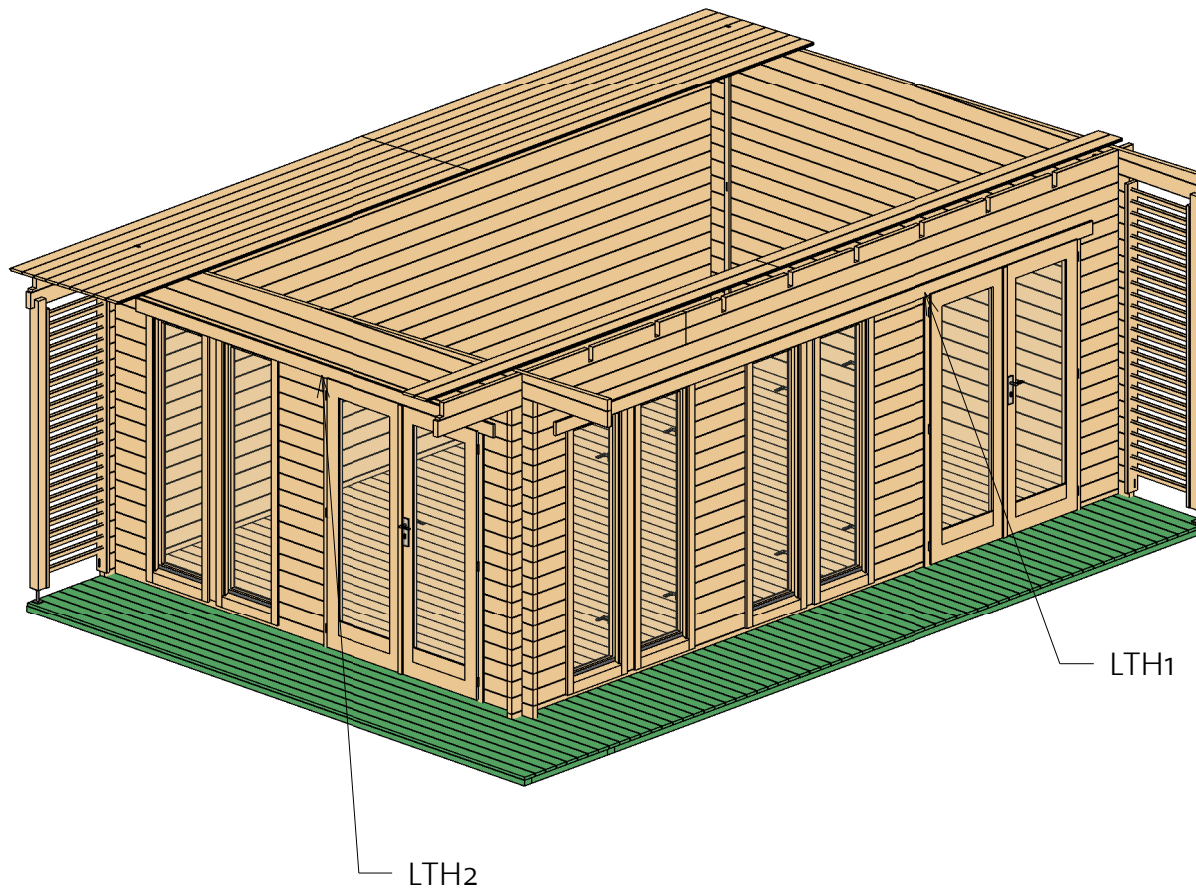

# Sabrina 40 (570x380)

Roof 3



| Lath list |       |   |       |        |
|-----------|-------|---|-------|--------|
| Mark      | Type  | Profile   | Count | Length |
| LTH1      | 18x95 |  | 2     | 5100   |
| LTH2      | 18x95 |  | 2     | 3300   |

# Sabrina 40 (570x380)

Terrace

③ Terrace element 1

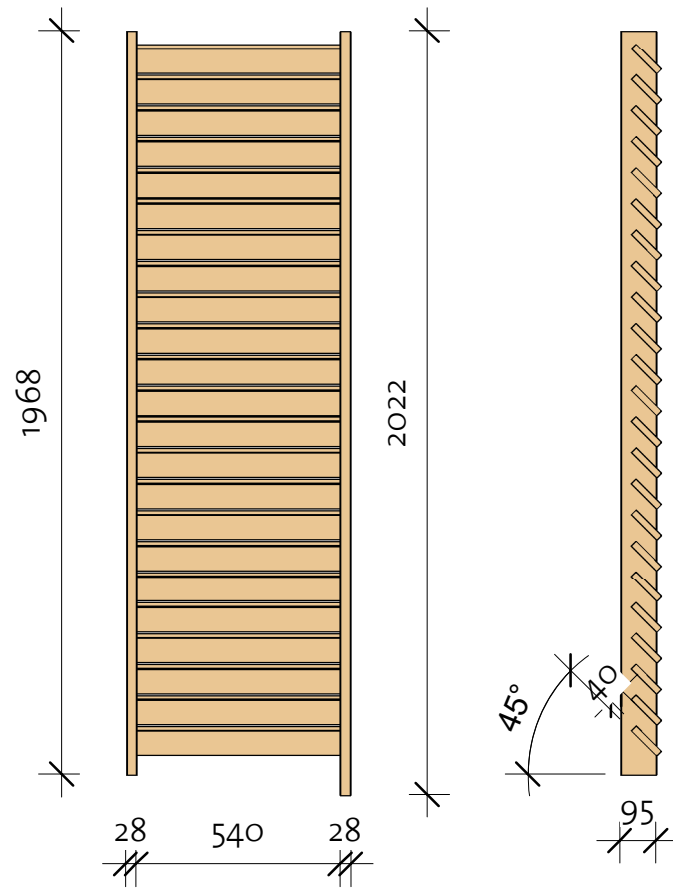

④ Terrace element 2

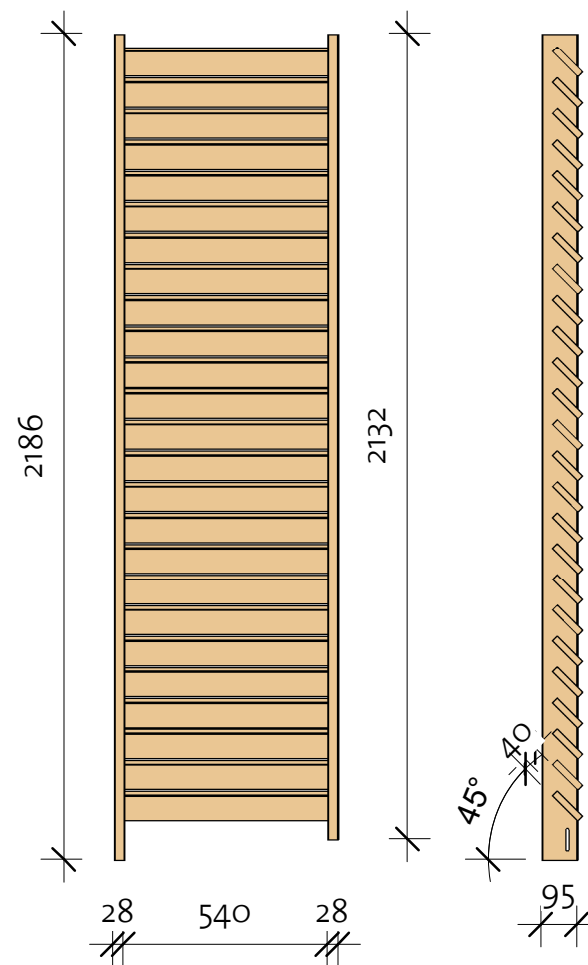

# Sabrina 40 (570x380)

Extras

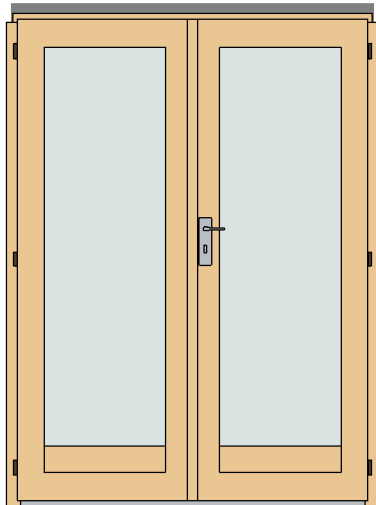

| Door Schedule |                             |       |        |       |
|---------------|-----------------------------|-------|--------|-------|
| Mark          | Type                        | Width | Height | Count |
| CDD3R         | Classic double door 3 right | 1425  | 1955   | 2     |
| DCB8          | Door Crossbar 8 optional    | --    | --     | 4     |
| DB1           | Door beam 1440 mm           | 40    | 12     | 2     |

| Type | Count | Length |
|------|-------|--------|
|------|-------|--------|

|                 |   |      |
|-----------------|---|------|
| Windboard 18x40 | 4 | 2300 |
|-----------------|---|------|



| Fasteners/Extras |      |       |
|------------------|------|-------|
| Name             | Type | Count |

|                      |            |      |
|----------------------|------------|------|
| Hitblock             | 300-400 mm |      |
| Adjustable post foot |            | 2    |
| Screwbolt            | M8x60      | 2    |
| Bolts                | M8 x 70    | 12   |
| Screws               | 5,0 x 70   | 40   |
| Nails                | 1,4 x 40   | 40   |
| Dowel                | 16,0 x 150 | 75   |
| Screws               | 6,0 x 140  | 110  |
| Screws               | 4,0 x 40   | 1800 |

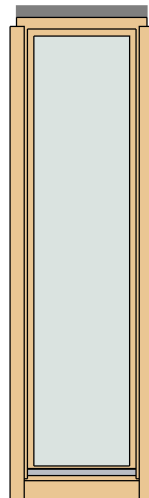

| Window Schedule |      |       |        |       |
|-----------------|------|-------|--------|-------|
| Mark            | Type | Width | Height | Count |

|       |                         |     |      |   |
|-------|-------------------------|-----|------|---|
| CW21R | Classic window 21 right | 515 | 1890 | 6 |
|-------|-------------------------|-----|------|---|

|      |                             |    |    |   |
|------|-----------------------------|----|----|---|
| WCB8 | Windows Crossbar 8 optional | -- | -- | 6 |
|------|-----------------------------|----|----|---|

\* Windows intended for tilt opening only!



# Sabrina 40 (570x380)

## List of all items 1

### Impregnated foundation beams

| Mark | Type         | Profile   | Count | Length |
|------|--------------|---|-------|--------|
| IFB1 | IFB<br>70x40 |  | 10    | 5570   |
| IFB2 | IFB<br>70x40 |   | 3     | 4590   |
| IFB3 | IFB<br>70x40 |   | 10    | 715    |

### Roof

| Mark | Type                | Profile   | Count | Length |
|------|---------------------|---|-------|--------|
| RFB  | Beam<br>40x143      |   | 9     | 4779   |
| RB1  | Roofboard<br>17x114 |  | 42    | 3335   |
| RB2  | Roofboard<br>17x114 |   | 42    | 3265   |



### Columns schedule

| Mark | Profile     | Count | Length |
|------|-------------|-------|--------|
| CM1  | Post 80x70  | 1     | 2045   |
| CM2  | Post 80x70  | 1     | 2216   |
| CM3  | Post 40x120 | 3     | 1890   |

### Terrace schedule



| Type              | Count | Type | Length | Count |
|-------------------|-------|------|--------|-------|
| Terrace element 1 | 1     | RS1  | 3282   | 2     |
|                   |       | RS2  | 3354   | 2     |
| Terrace element 2 | 1     | RS3  | 4772   | 2     |

### Floor Schedule



| Mark | Type      | Profile   | Count | Length |
|------|-----------|---|-------|--------|
| FB   | FB 17x114 |  | 51    | 3714   |
| TB1  | TB 21x95  |  | 8     | 4590   |
| TB2  | TB 21x95  |   | 58    | 795    |

|     |             |   |      |   |
|-----|-------------|---|------|---|
| BB1 | BB<br>20x40 |  | 5700 | 2 |
| BB2 | BB<br>20x40 |   | 3800 | 2 |

### Fascia Schedule

| Mark | Type                 | Profile   | Count | Length |
|------|----------------------|---|-------|--------|
| EE1  | Eave Edging<br>18x95 |  | 2     | 3303   |
| EE2  | Eave Edging<br>18x95 |  | 2     | 4685   |

### Lath list

| Mark | Type  | Profile   | Count | Length |
|------|-------|---|-------|--------|
| LTH1 | 18x95 |  | 2     | 5100   |
| LTH2 | 18x95 |  | 2     | 3300   |

# Sabrina 40 (570x380)

## List of all items 2

| Wall 1 |         |       |            |
|--------|---------|-------|------------|
| Mark   | Profile | Count | Cut Length |

|       |        |    |      |
|-------|--------|----|------|
| 1BL-1 | 40X57  | 1  | 535  |
| 1BL-2 | 40X57  | 1  | 3925 |
| 1LG-1 | 40X114 | 1  | 5900 |
| 1LG-2 | 40X114 | 34 | 535  |
| 1LG-3 | 40X114 | 34 | 535  |
| 1LG-4 | 40X114 | 1  | 4250 |
| 1LG-5 | 40X114 | 1  | 2351 |
| 1LG-6 | 40X114 | 1  | 5900 |
| 1TL-1 | 40X114 | 1  | 4250 |
| 1TL-2 | 40X114 | 1  | 2333 |

| Wall 2 |         |       |            |
|--------|---------|-------|------------|
| Mark   | Profile | Count | Cut Length |

|       |        |    |      |
|-------|--------|----|------|
| 2BL-1 | 40X57  | 1  | 5900 |
| 2LG-1 | 40X114 | 1  | 2351 |
| 2LG-2 | 40X114 | 17 | 5900 |
| 2LG-3 | 40X114 | 1  | 4250 |
| 2LG-4 | 40X114 | 1  | 5900 |
| 2TL-1 | 40X114 | 1  | 4250 |
| 2TL-2 | 40X114 | 1  | 2333 |

| Wall A |         |       |            |
|--------|---------|-------|------------|
| Mark   | Profile | Count | Cut Length |

|        |        |    |      |
|--------|--------|----|------|
| ALG-1  | 40X114 | 1  | 4000 |
| ALG-2  | 40X114 | 33 | 466  |
| ALG-3  | 40X114 | 16 | 468  |
| ALG-4* | 40X114 | 1  | 2661 |
| ALG-5  | 40X114 | 2  | 4000 |
| ALG-6* | 40X114 | 1  | 4681 |
| ALG-7  | 40X114 | 1  | 2094 |

| Wall B |         |       |            |
|--------|---------|-------|------------|
| Mark   | Profile | Count | Cut Length |



|        |        |    |      |
|--------|--------|----|------|
| BLG-1* | 40X114 | 1  | 2661 |
| BLG-2  | 40X114 | 20 | 4000 |
| BLG-3* | 40X114 | 1  | 4681 |

\* Gable - delivered premounted

| Log Profiles |         |
|--------------|---------|
| Profile      | Profile |

|       |   |
|-------|---|
| 40X57 |  |
|-------|---|

| Log Profiles |         |
|--------------|---------|
| Profile      | Profile |

|        |   |
|--------|---|
| 40X114 |  |
| 40X114 |  |