

# Wildlife Bunkie 40 (353x285)

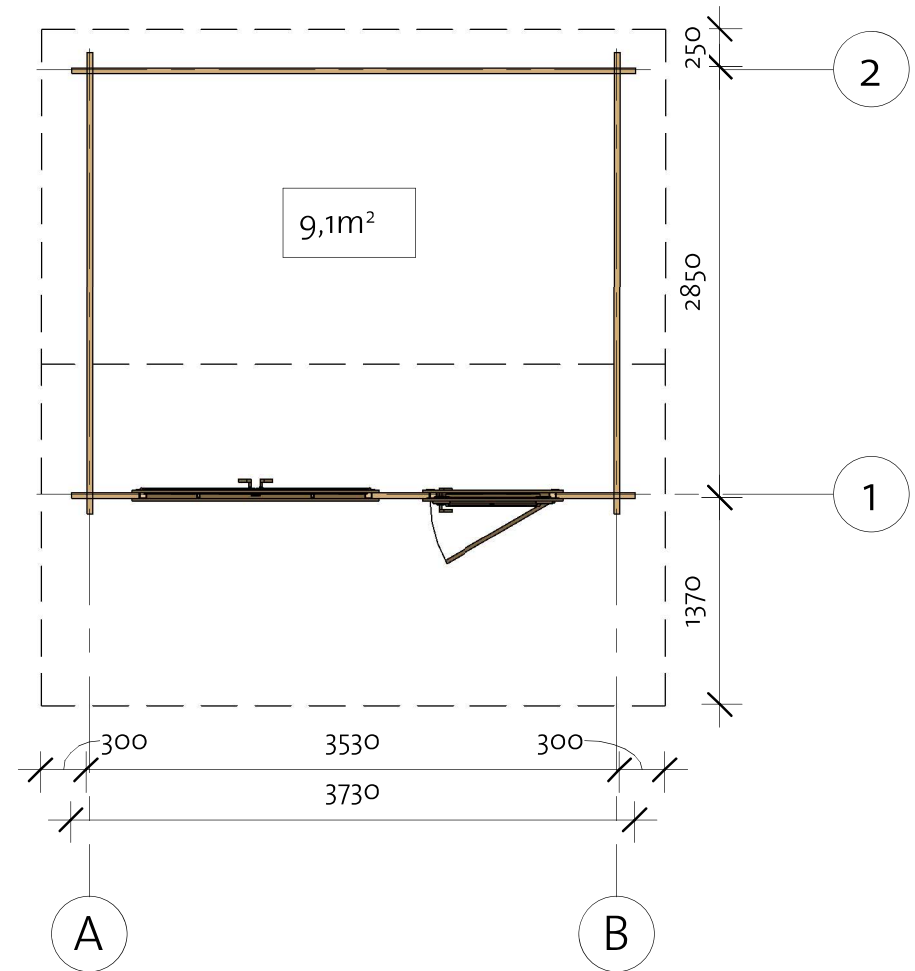
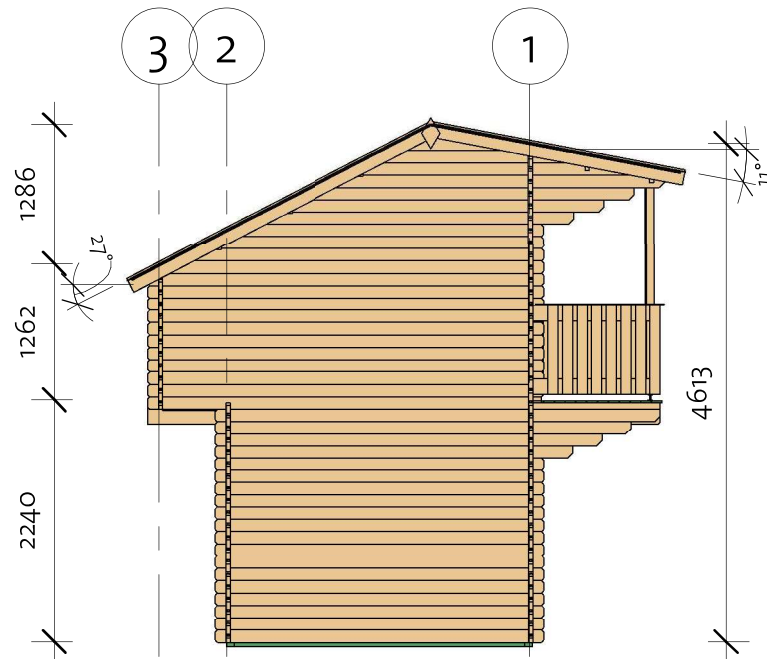

92202041\_220314

# Wildlife Bunkie 40 (353x285)

Foundation

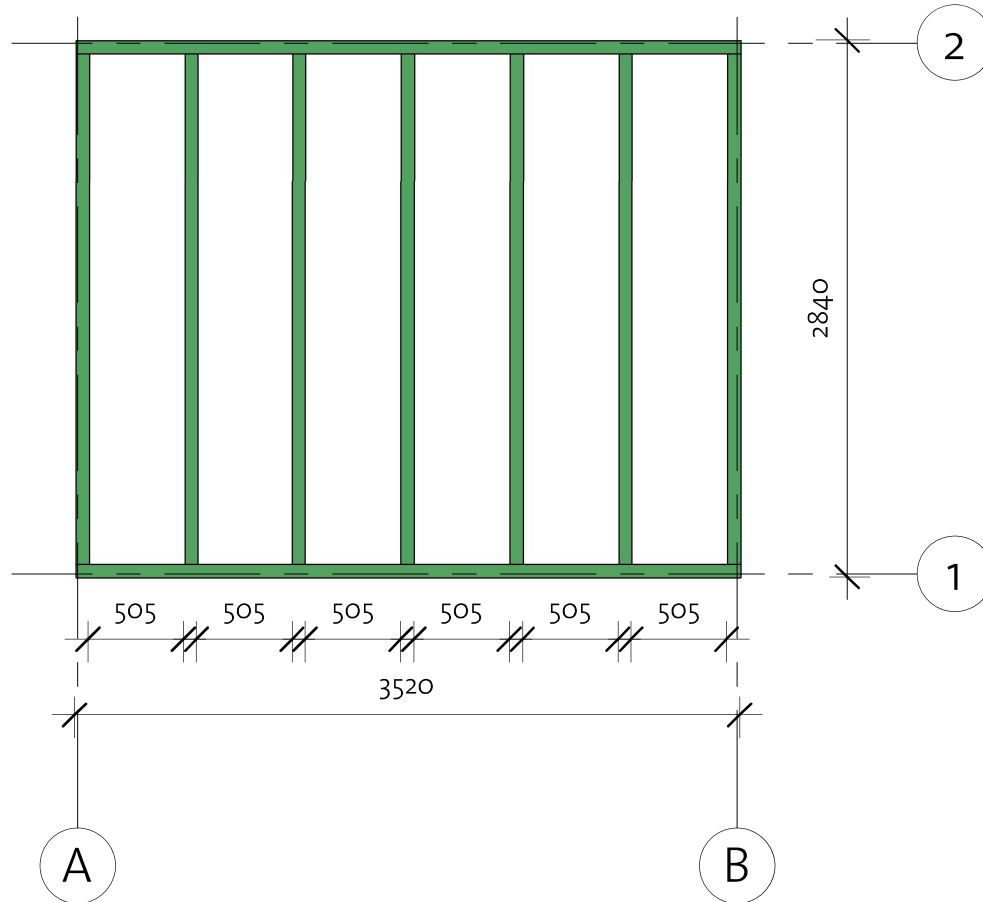



Impregnated foundation beams				
Mark	Type	Profile	Count	Length
IFB1	IFB 70x40		2	3520
IFB2	IFB 70x40		7	2700

# Wildlife Bunkie 40 (353x285)

Floor Plan

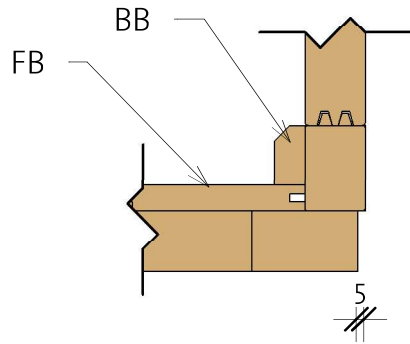
① Baseboard



Floor Schedule				
Mark	Type	Profile	Count	Length
FB1	FB 17x114		25	3444
BB1	BB 20x40		6	3600
BB2	BB 20x40		2	2900

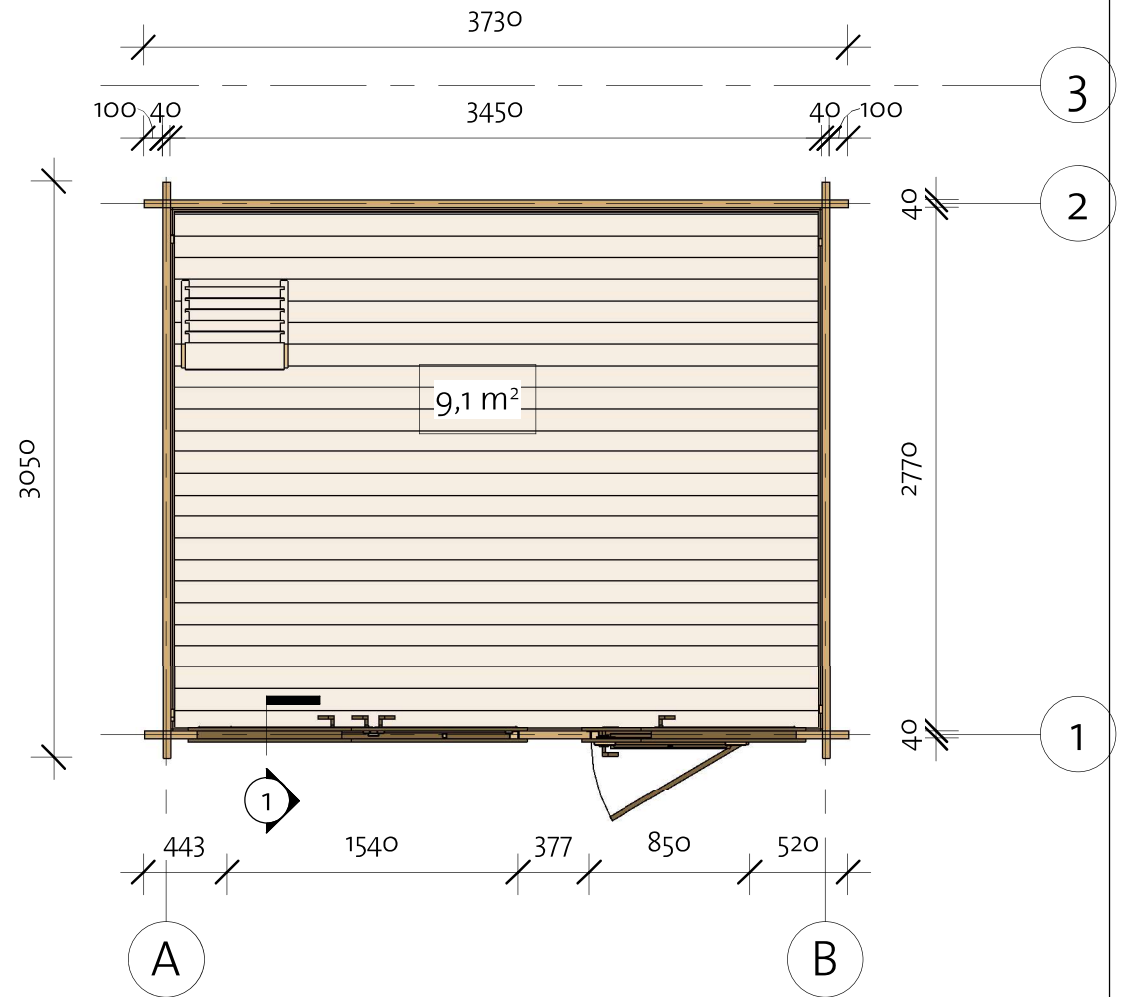

# Wildlife Bunkie 40 (353x285)

Wall 1

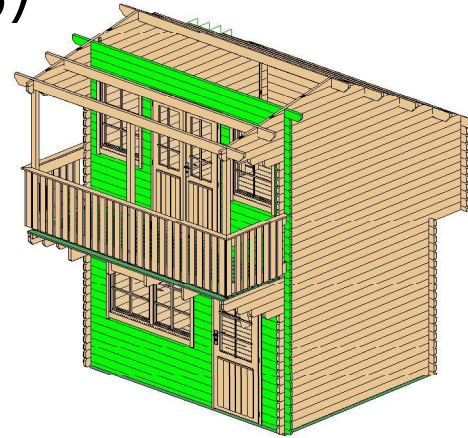
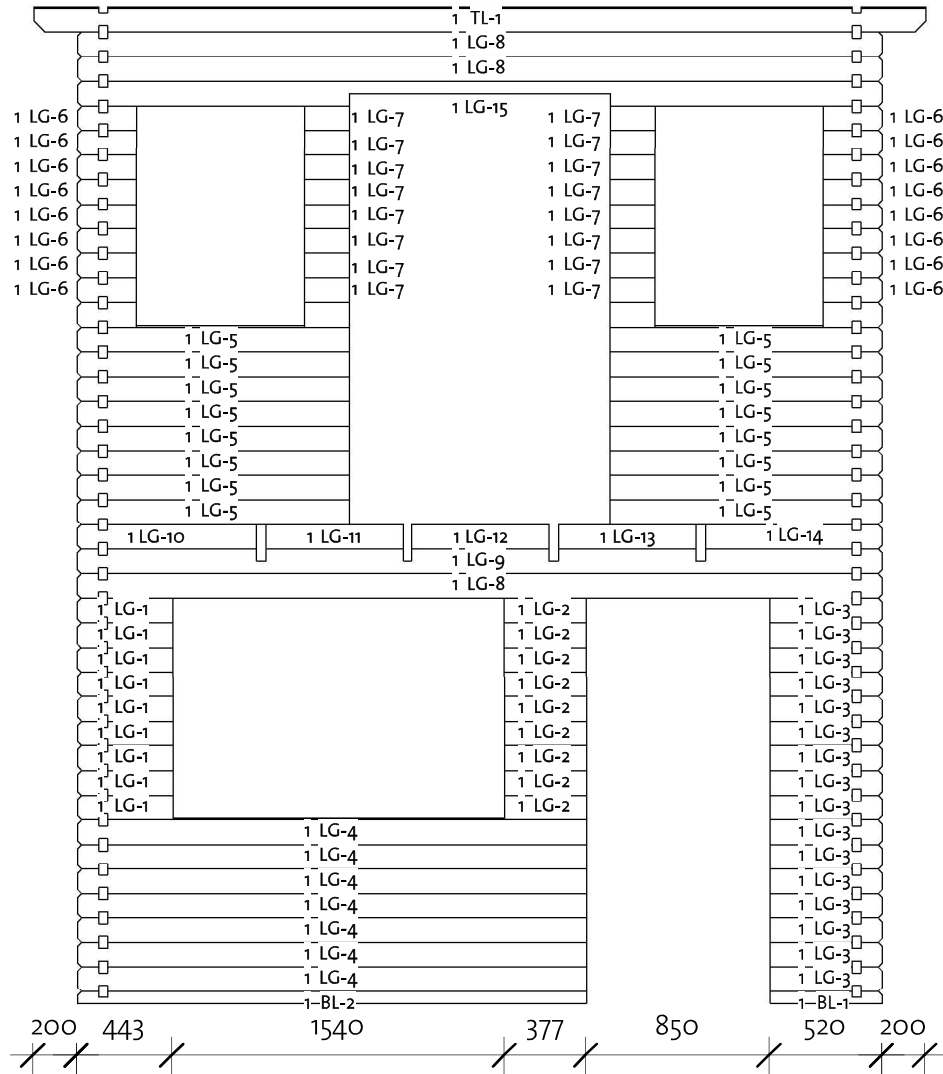

Log Profile Wall 1

Profile Profile

40x57	
40x114	
40x114	
40x114	

Wall 1

Mark	Profile	Count	Cut Length
1BL-1	40x57	1	520
1BL-2	40x57	1	2360
1LG-1	40x114	9	443
1LG-2	40x114	9	377
1LG-3	40x114	16	520
1LG-4	40x114	7	2360
1LG-5	40x114	16	1258
1LG-6	40x114	18	275
1LG-7	40x114	18	208
1LG-8	40x114	3	3730
1LG-9	40x114	1	3730
1LG-10	40x114	1	829
1LG-11	40x114	1	635
1LG-12	40x114	1	635
1LG-13	40x114	1	635
1LG-14	40x114	1	817
1LG-15	40x114	1	3730
1TL-1	40x114	1	4130

92202041\_220316

# Wildlife Bunkie 40 (353x285)

Wall 2

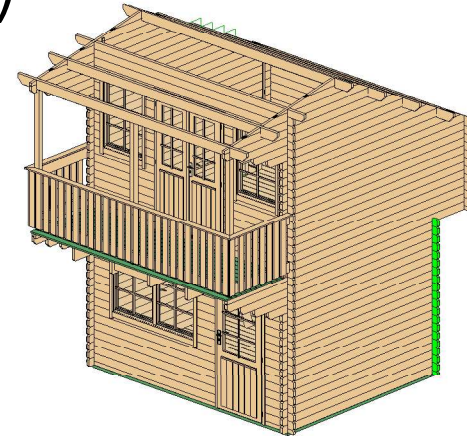

Wall 2			
Mark	Profile	Count	Cut Length

2BL-1	40X57	1	3730
2LG-1	40X114	17	3730
2LG-2	40X114	1	829
2LG-3	40X114	3	635
2LG-4	40X114	1	817
2LG-5	40X114	1	3730

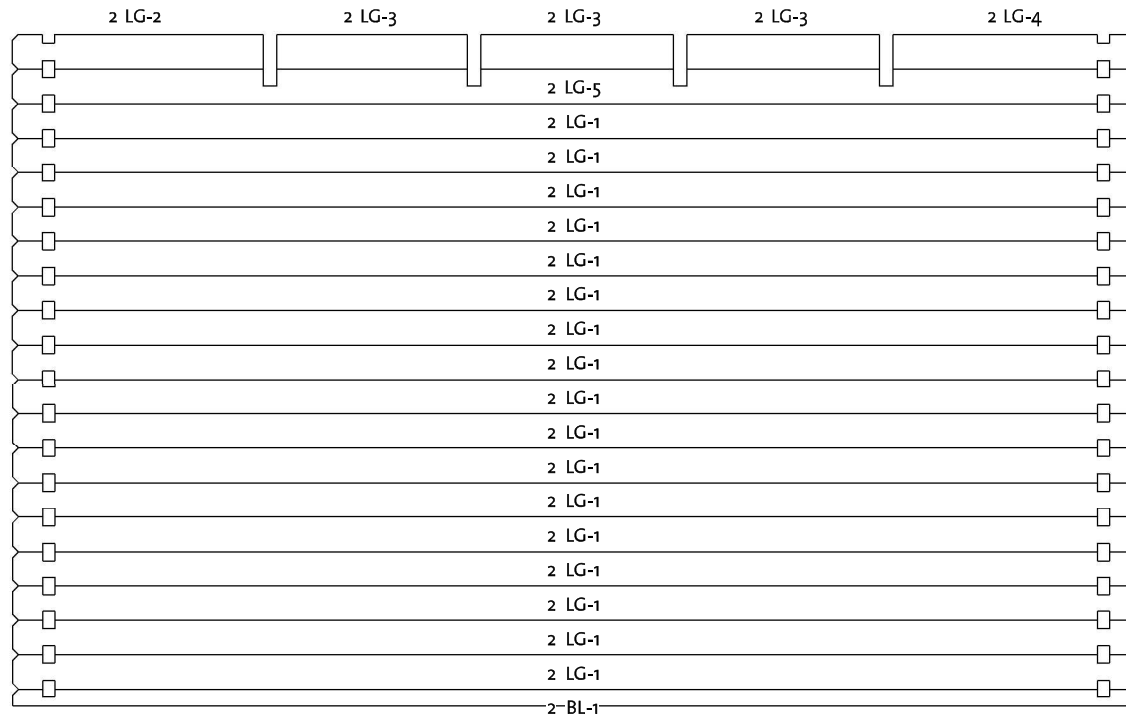

Log Profile Wall 2	
Profile	Profile

40X57	
40X114	
40X114	

# Wildlife Bunkie 40 (353x285)

Wall 3

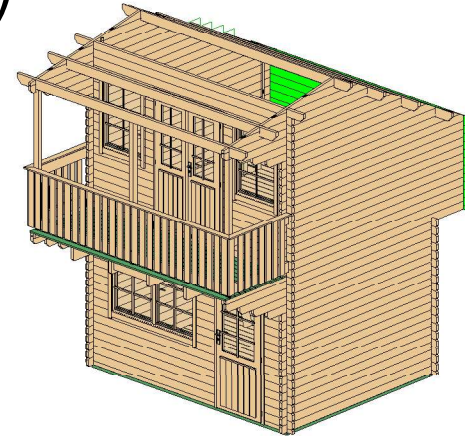

Wall 3			
Mark	Profile	Count	Cut Length
3BL-1	40X57	1	3730
3LG-1	40X114	10	3730
3TL-1	40X139	1	4130

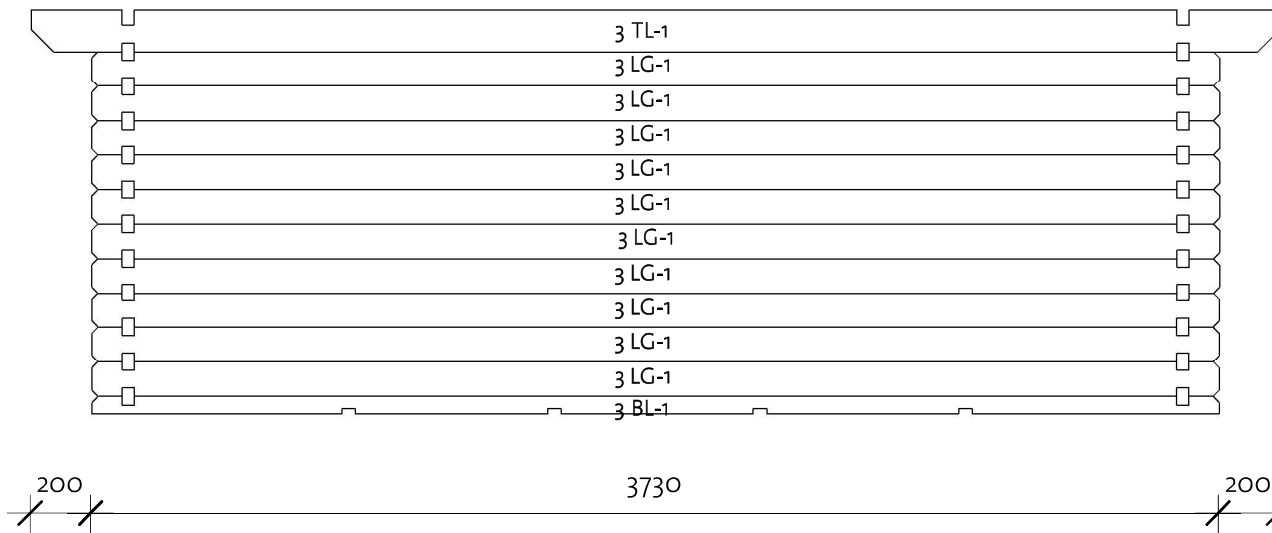

Log Profile Wall 3	
Profile	Profile

40X57	
40X114	
40X139	

# Wildlife Bunkie 40 (353x285)

Wall A

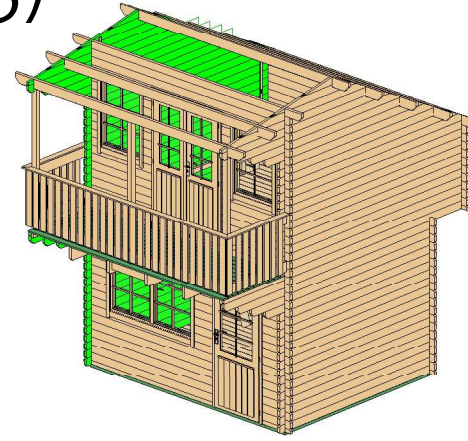
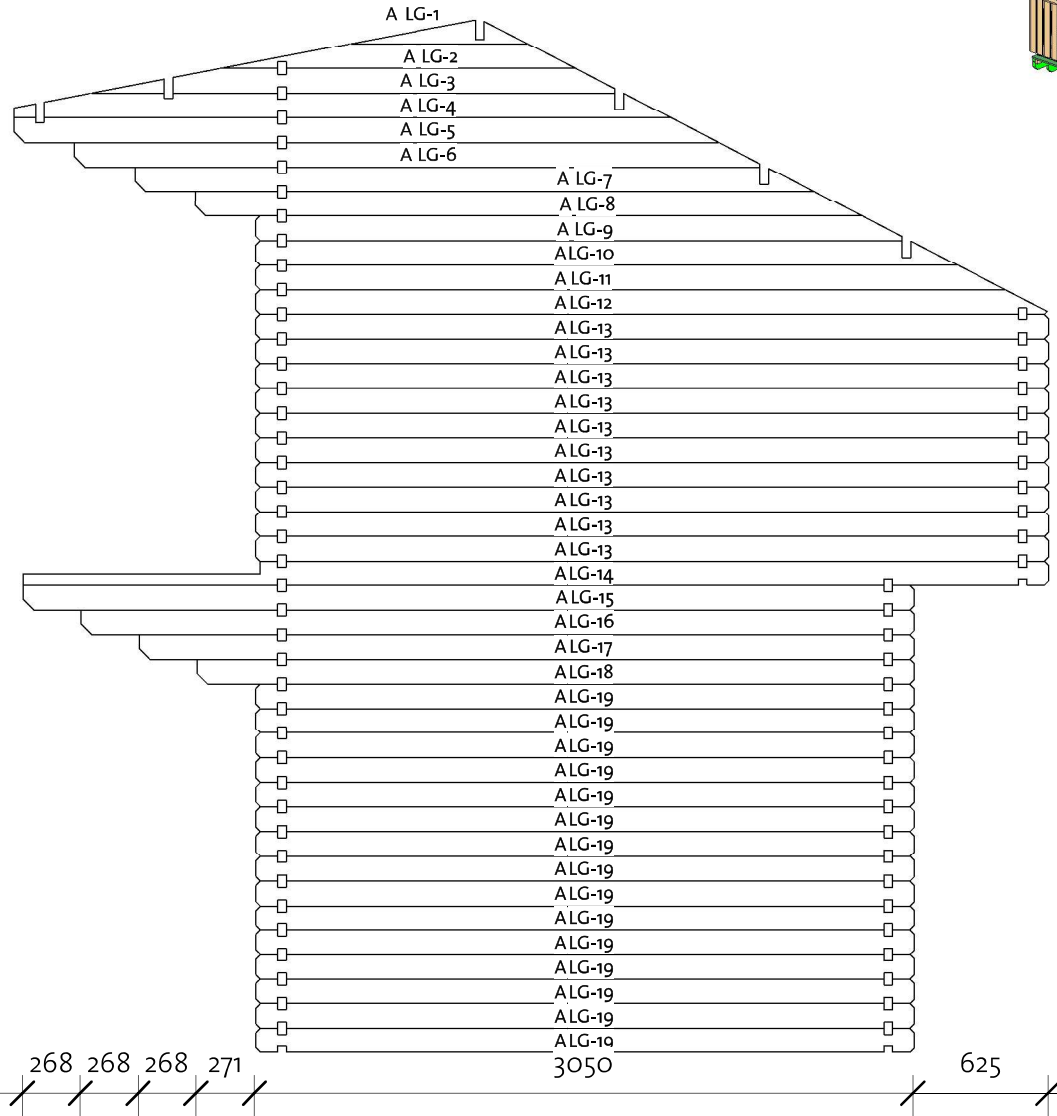

Wall A			
Mark	Profile	Count	Cut Length

ALG-1 *	40X114	1	821
ALG-2 *	40X114	1	1642
ALG-3 *	40X114	1	2426
ALG-4 *	40X114	1	3045
ALG-5 *	40X114	1	3266
ALG-6 *	40X114	1	3176
ALG-7 *	40X114	1	3148
ALG-8 *	40X114	1	3089
ALG-9 *	40X114	1	2994
ALG-10 *	40X114	1	3252
ALG-11 *	40X114	1	3473
ALG-12 *	40X114	1	3668
ALG-13	40X114	10	3675
ALG-14	40X114	1	4750
ALG-15	40X114	1	4125
ALG-16	40X114	1	3857
ALG-17	40X114	1	3589
ALG-18	40X114	1	3321
ALG-19	40X114	15	3050

Log Profile Wall A

Profile

Profile

40X114



\* Gable - delivered premounted

92202041\_220316

# Wildlife Bunkie 40 (353x285)

Wall B

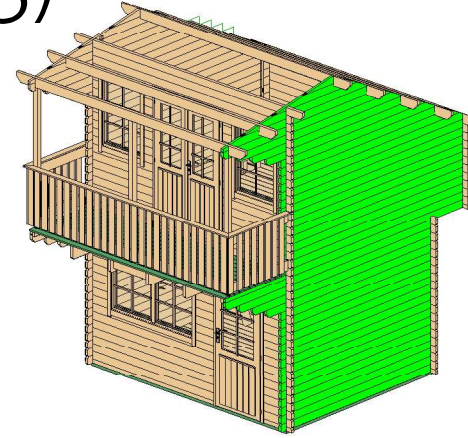
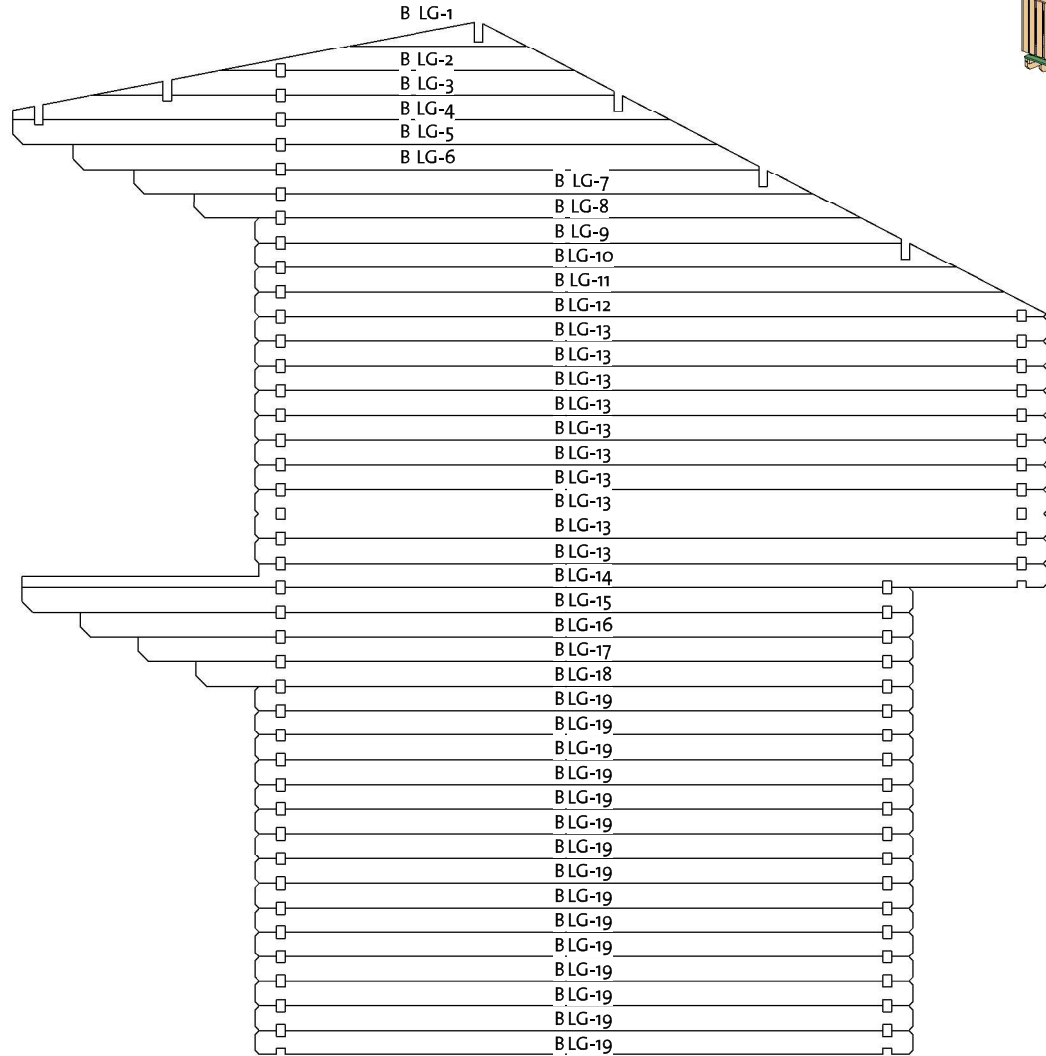

Wall B

Mark	Profile	Count	Cut Length
------	---------	-------	------------

BLG-1 *	40X114	1	821
BLG-2 *	40X114	1	1642
BLG-3 *	40X114	1	2426
BLG-4 *	40X114	1	3045
BLG-5 *	40X114	1	3266
BLG-6 *	40X114	1	3176
BLG-7 *	40X114	1	3148
BLG-8 *	40X114	1	3089
BLG-9 *	40X114	1	2994
BLG-10 *	40X114	1	3252
BLG-11 *	40X114	1	3473
BLG-12 *	40X114	1	3668
BLG-13	40X114	10	3675
BLG-14	40X114	1	4750
BLG-15	40X114	1	4125
BLG-16	40X114	1	3857
BLG-17	40X114	1	3589
BLG-18	40X114	1	3321
BLG-19	40X114	15	3050

Log Profile Wall B

Profile	Profile
---------	---------

40X114



\* Gable - delivered premounted

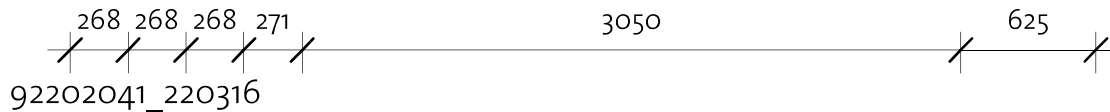



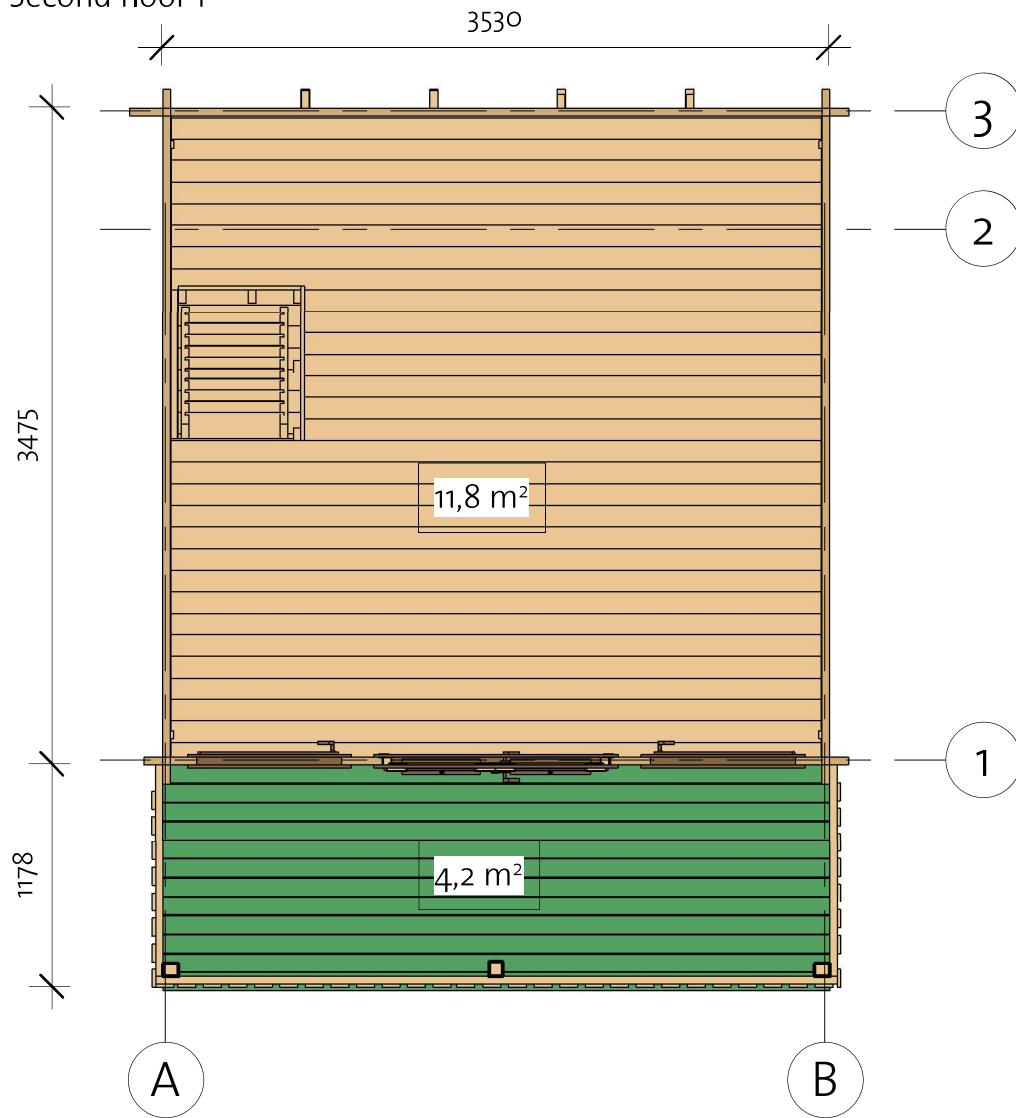

# Wildlife Bunkie 40 (353x285)

Second floor 1



Second Floor Schedule				
Mark	Type	Profile	Count	Length

FB2	FB 17x114		24	3444
FB3	FB 17x114		7	2758
TB	TB 21x95		13	3530

# Wildlife Bunkie 40 (353x285)

Second floor 2

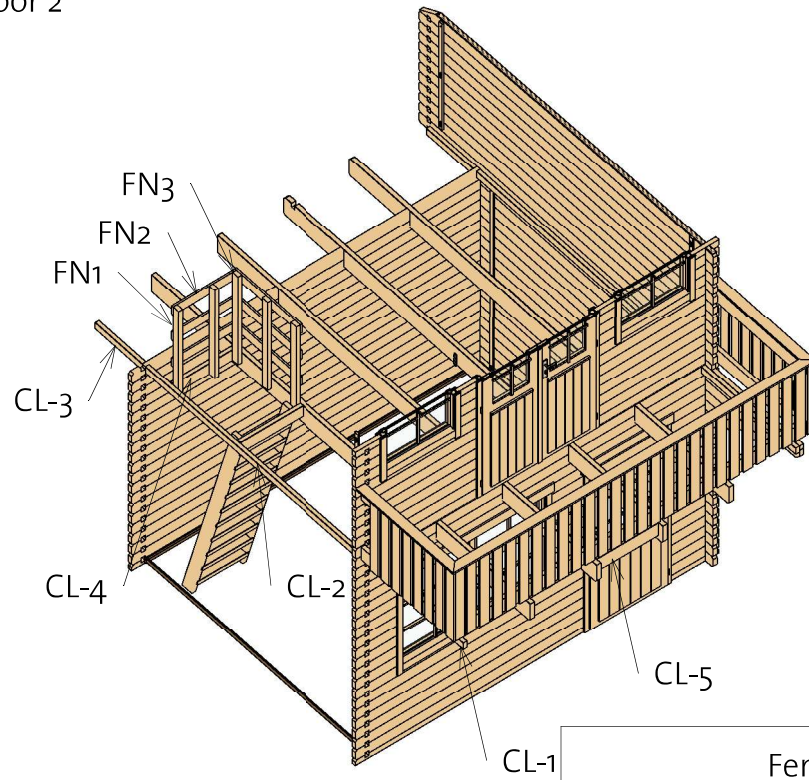

Fence schedule				
Mark	Type	Profile	Count	Length

FN1	Fence 40x70		5	1000
FN2	Fence 18x95		3	649

Second floor 2				
Mark	Type	Profile	Count	Length

CL-1	Ceiling beam 40x70		2	1175
CL-2	Ceiling beam 40x70		2	2770
CL-3	Ceiling beam 40x70		2	585
CL-4	Ceiling beam 40x120		2	649
CL-5	Ceiling beam 40x143		2	635

Fence schedule				
Mark	Type	Profile	Count	Length

FN3	Fence 18x95		3	818
-----	----------------	--	---	-----

# Wildlife Bunkie 40 (353x285)

Terrace Fence

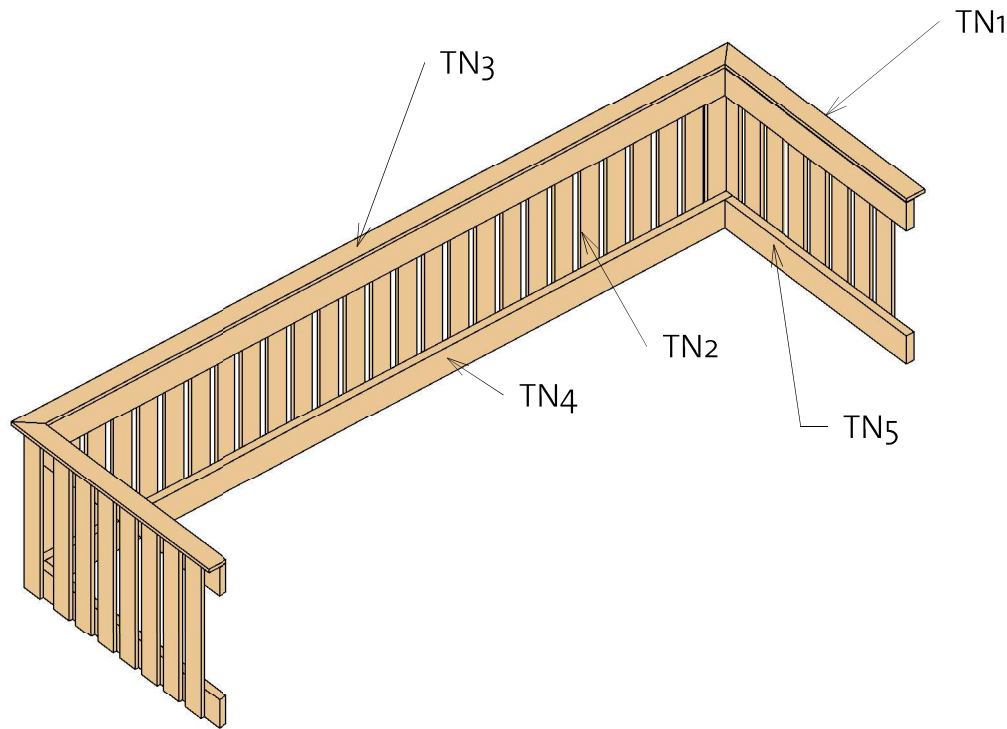

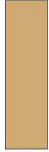
Terrace Fence				
Mark	Profile	Profile	Count	Length
TN1	Fence 18x95		2	1215
TN2	Fence 18x95		43	822
TN3	Fence 18x95		1	3720
TN4	Fence 40x143		2	3613
TN5	Fence 40x143		4	1120

# Wildlife Bunkie 40 (353x285)

Roof 1

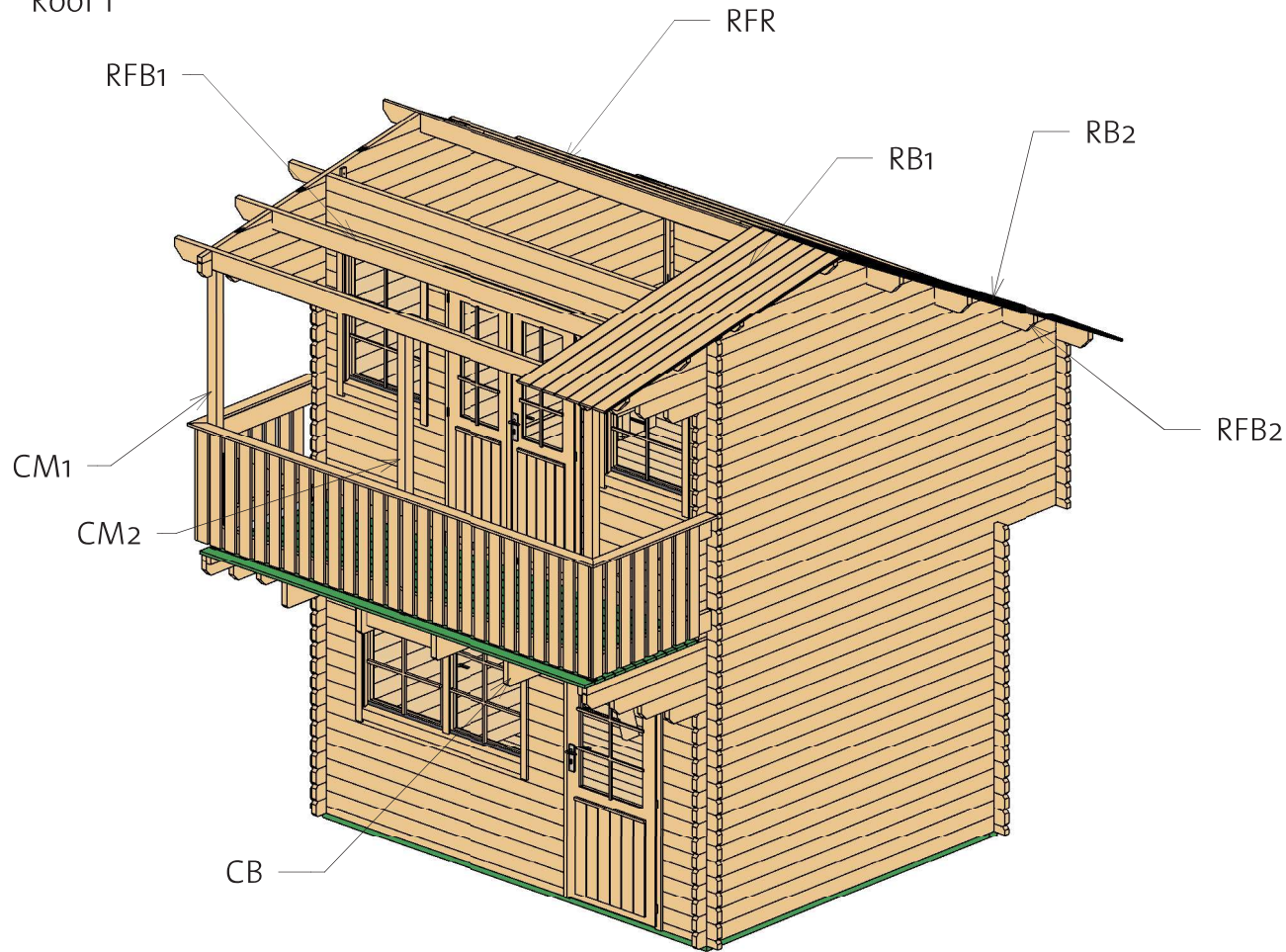

Roof				
Mark	Type	Profile	Count	Length

RB1	17x114		38	2348
RB2	17x114		38	3123
RFB1	Beam 40x143		2	4130
RFB2	Beam 40x143		3	4130
RFR	Ridge 40x143		1	4130

Ceiling Beams				
Mark	Type	Profile	Count	Length

CB	Ceiling beam 45x195		4	4750
----	---------------------	--	---	------

Columns			
Mark	Profile	Count	Length

CM1	Post 80x70	2	1957
CM2	Post 80x70	1	2014

# Wildlife Bunkie 40 (353x285)

Roof 2



2 Roof Reinforcement

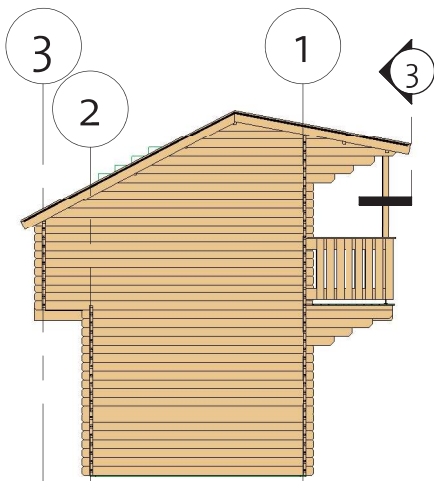
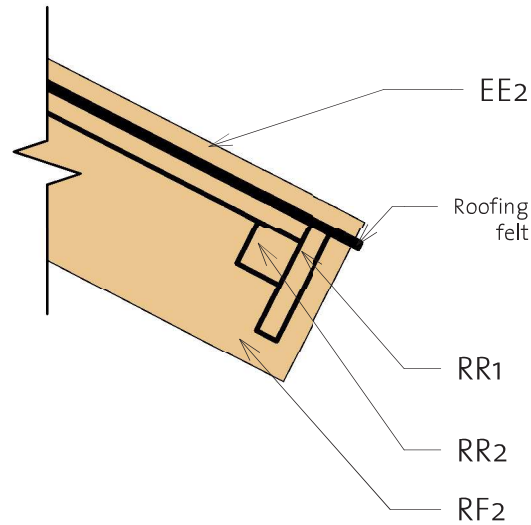

3 Fascia

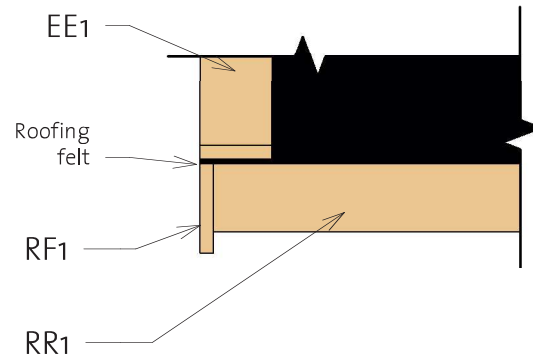





Fascia Schedule

Mark	Type	Profile	Count	Length
EE1	Eave Edging 18x95		2	2389
EE2	Eave Edging 18x95		2	3170
RF1	Roof Fascia 18x120		2	2389
RF2	Roof Fascia 18x120		2	3171
RR1	Roof reinforcement 18x95		2	4130
RR2	Roof reinforcement 38x38		2	4130

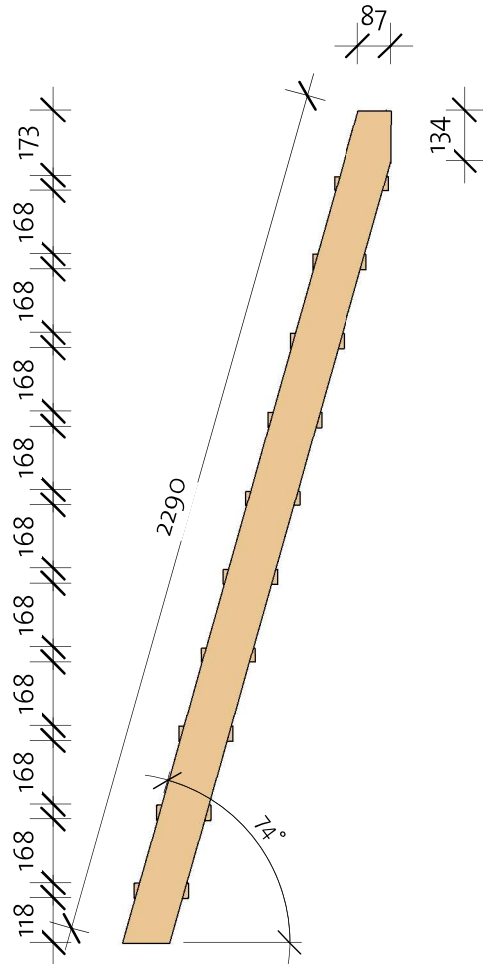
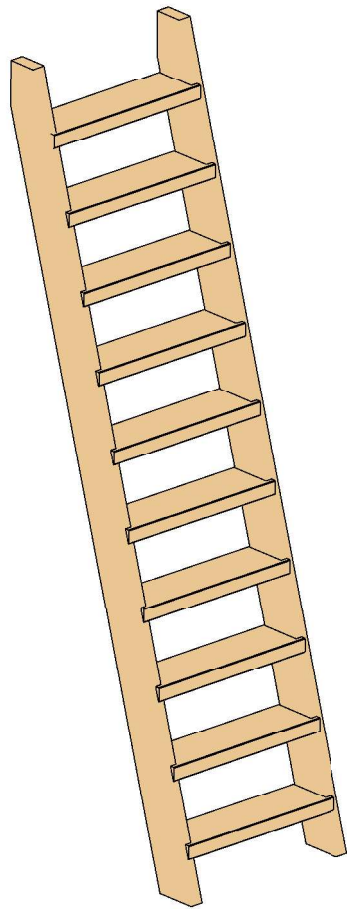
# Wildlife Bunkie 40 (353x285)

Stairs



Stairs				
Mark	Profile	Profile	Count	Cut Length
ST1L	Stair 40X120		1	2313
ST1R	Stair 40X120		1	2313
ST2	Stair 40X143		10	520

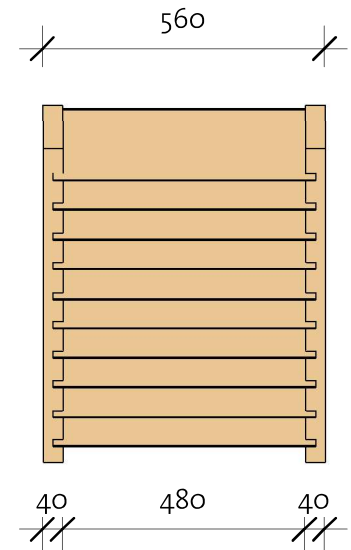

# Wildlife Bunkie 40 (353x285)

Extras



Door Schedule				
Model	Type	Width	Height	Count
CD9R	Classic door 9 right	840	1835	1
CDD5R	Classic double door 5 right	1200	1955	1
DCB6	Door Crossbar 6	--	--	1
DCB6-1	Door Crissbar 6-1			1

Fasteners/Extras		
Name	Type	Count

Hitblock	300-400 mm	
Adjustable post foot		3
Bolts	M8 x 70	16
Screws	6,0 x 140	65
Nails	1,4 x 40	65
Screws	5,0 x 70	100
Screws	4,0 x 40	1200

Window Schedule				
Mark	Type	Width	Height	Count
DB	Door beam 1215 mm	40	12	1
CDW1	Classic double window 1	1530	990	1
CW1L	Classic window 1 left	765	990	1
CW1R	Classic window 1 right	765	990	1
WCB6	Windows Crossbar 6	--	--	6

Type	Count
------	-------

Windboard 18x40 2300	2
Windboard 18x40x1200	2
Windboard 18x40x2200	4

Type	Count
------	-------

Romb	2
------	---

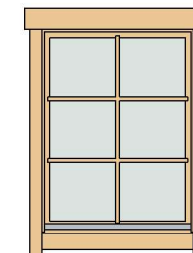
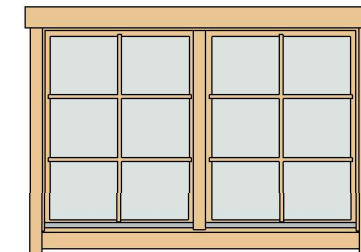
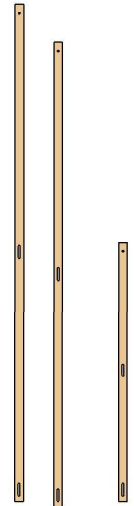

# Wildlife Bunkie 40 (353x285)

## List of all items 1







Impregnated foundation beams				
Mark	Type	Profile	Count	Length

IFB1	IFB 70x40		2	3520
IFB2	IFB 70x40		7	2700

Floor Schedule				
Mark	Type	Profile	Count	Length

FB1	FB 17x114		25	3444
-----	-----------	---	----	------

Fascia Schedule				
Mark	Type	Profile	Count	Length

EE1	Eave Edging 18x95		2	2389
EE2	Eave Edging 18x95		2	3170
RF1	Roof Fascia 18x120		2	2389
RF2	Roof Fascia 18x120		2	3171
RR1	Roof reinforcement 18x95		2	4130
RR2	Roof reinforcement 38x38		2	4130

BB1	BB 20x40		6	3600
BB2	BB 20x40		2	2900

Roof				
Mark	Type	Profile	Count	Length

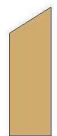
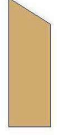
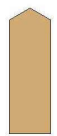
RB1	17x114		38	2348
RB2	17x114		38	3123
RFB1	Beam 40x143		2	4130
RFB2	Beam 40x143		3	4130
RFR	Ridge 40x143		1	4130



# Wildlife Bunkie 40 (353x285)

## List of all items 2

Wall A			
Mark	Profile	Count	Cut Length

ALG-1 *	40X114	1	821
ALG-2 *	40X114	1	1642
ALG-3 *	40X114	1	2426
ALG-4 *	40X114	1	3045
ALG-5 *	40X114	1	3266
ALG-6 *	40X114	1	3176
ALG-7 *	40X114	1	3148
ALG-8 *	40X114	1	3089
ALG-9 *	40X114	1	2994
ALG-10 *	40X114	1	3252
ALG-11 *	40X114	1	3473
ALG-12 *	40X114	1	3668
ALG-13	40X114	10	3675
ALG-14	40X114	1	4750
ALG-15	40X114	1	4125
ALG-16	40X114	1	3857
ALG-17	40X114	1	3589
ALG-18	40X114	1	3321
ALG-19	40X114	15	3050

Wall B			
Mark	Profile	Count	Cut Length

BLG-1 *	40X114	1	821
BLG-2 *	40X114	1	1642
BLG-3 *	40X114	1	2426
BLG-4 *	40X114	1	3045
BLG-5 *	40X114	1	3266
BLG-6 *	40X114	1	3176
BLG-7 *	40X114	1	3148
BLG-8 *	40X114	1	3089
BLG-9 *	40X114	1	2994
BLG-10 *	40X114	1	3252
BLG-11 *	40X114	1	3473
BLG-12 *	40X114	1	3668
BLG-13	40X114	10	3675
BLG-14	40X114	1	4750
BLG-15	40X114	1	4125
BLG-16	40X114	1	3857
BLG-17	40X114	1	3589
BLG-18	40X114	1	3321
BLG-19	40X114	15	3050

\* Gable - delivered premounted

# Wildlife Bunkie 40 (353x285)

## List of all items 3

Wall 1			
Mark	Profile	Count	Cut Length

1BL-1	40X57	1	520
1BL-2	40X57	1	2360
1LG-1	40X114	9	443
1LG-2	40X114	9	377
1LG-3	40X114	16	520
1LG-4	40X114	7	2360
1LG-5	40X114	16	1258
1LG-6	40X114	18	275
1LG-7	40X114	18	208
1LG-8	40X114	3	3730
1LG-9	40X114	1	3730
1LG-10	40X114	1	829
1LG-11	40X114	1	635
1LG-12	40X114	1	635
1LG-13	40X114	1	635
1LG-14	40X114	1	817
1LG-15	40X114	1	3730
1TL-1	40X114	1	4130

Wall 3			
Mark	Profile	Count	Cut Length

3BL-1	40X57	1	3730
3LG-1	40X114	10	3730
3TL-1	40X139	1	4130



Wall 2			
Mark	Profile	Count	Cut Length

2BL-1	40X57	1	3730
2LG-1	40X114	17	3730
2LG-2	40X114	1	829
2LG-3	40X114	3	635
2LG-4	40X114	1	817
2LG-5	40X114	1	3730

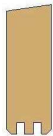
Log profiles	
Profile	Profile



40X57	
40X114	

Log profiles	
Profile	Profile



40X114	
40X114	
40X139	



# Wildlife Bunkie 40 (353x285)

## List of all items 4

Second Floor Schedule				
Mark	Type	Profile	Count	Length
FB2	FB 17x114		24	3444
FB3	FB 17x114		7	2758
TB	TB 21x95		13	3530

Second floor 2				
Mark	Type	Profile	Count	Length

CL-1	Ceiling beam 40x70		2	1175
CL-2	Ceiling beam 40x70		2	2770
CL-3	Ceiling beam 40x70		2	585
CL-4	Ceiling beam 40x120		2	649
CL-5	Ceiling beam 40x143		2	635



Fence schedule				
Mark	Type	Profile	Count	Length
FN1	Fence 40x70		5	1000
FN2	Fence 18x95		3	649



Fence schedule				
Mark	Type	Profile	Count	Length

FN3	Fence 18x95		3	818
-----	----------------	--	---	-----

# Wildlife Bunkie 40 (353x285)

## List of all items 5

Terrace Fence				
Mark	Profile	Profile	Count	Length
TN1	Fence 18x95		2	1215
TN2	Fence 18x95		43	822
TN3	Fence 18x95		1	3720
TN4	Fence 40x143		2	3613
TN5	Fence 40x143		4	1120

Stairs				
Mark	Profile	Profile	Count	Cut Length
ST1L	Stair 40x120		1	2313
ST1R	Stair 40x120		1	2313
ST2	Stair 40x143		10	520

Columns			
Mark	Profile	Count	Length
CM1	Post 80x70	2	1957
CM2	Post 80x70	1	2014

Ceiling Beams				
Mark	Type	Profile	Count	Length
CB	Ceiling beam 45x195		4	4750