

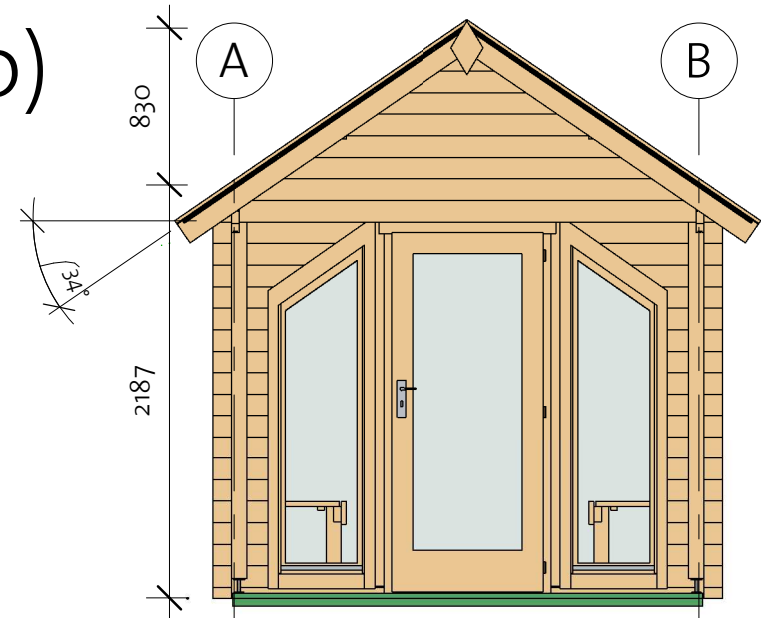

# Sauna Dockside A 40 (250x250)

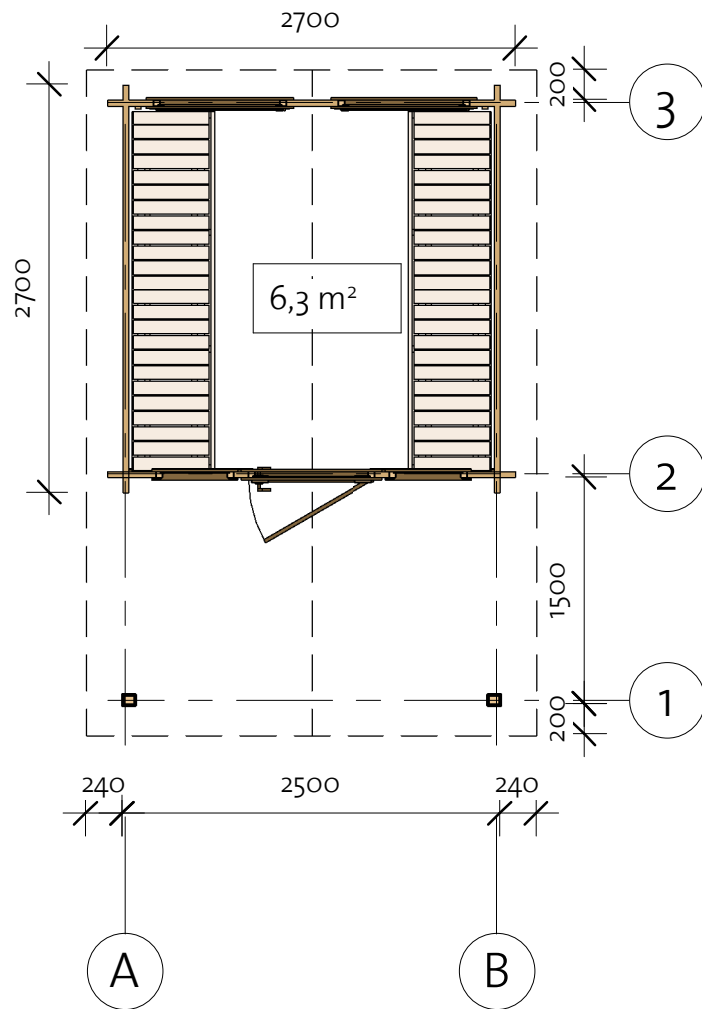
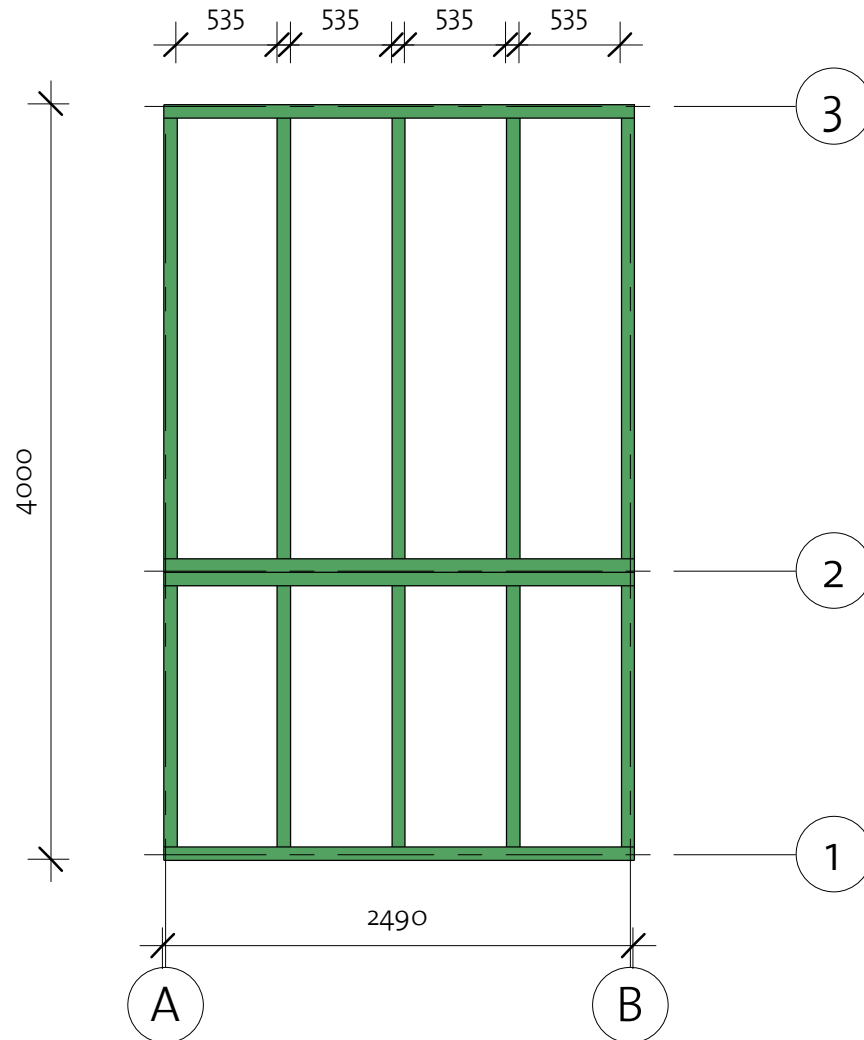

# Sauna Dockside A 40 (250x250)

Foundation

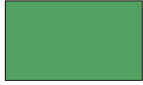

Impregnated foundation beams				
Mark	Type	Profile	Count	Length
IFB1	IFB 70x40		5	2335
IFB2	IFB 70x40		4	2490
IFB3	IFB 70x40		5	1385

# Sauna Dockside A 40 (250x250)

Floor Plan

① Baseboard

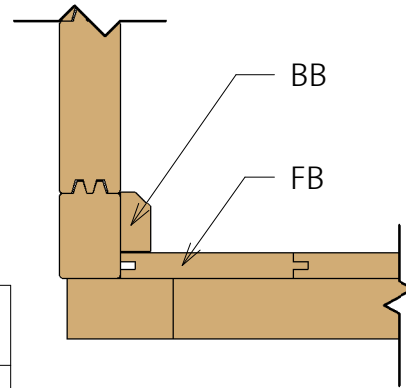

Floor Schedule				
Mark	Type	Profile	Count	Length

FB	FB 17x114		22	2414
----	-----------	---	----	------

Terrace Schedule				
------------------	--	--	--	--

TB	TB 28x120		12	2490
----	-----------	---	----	------

BB	BB 18x40		4	2500
----	----------	---	---	------

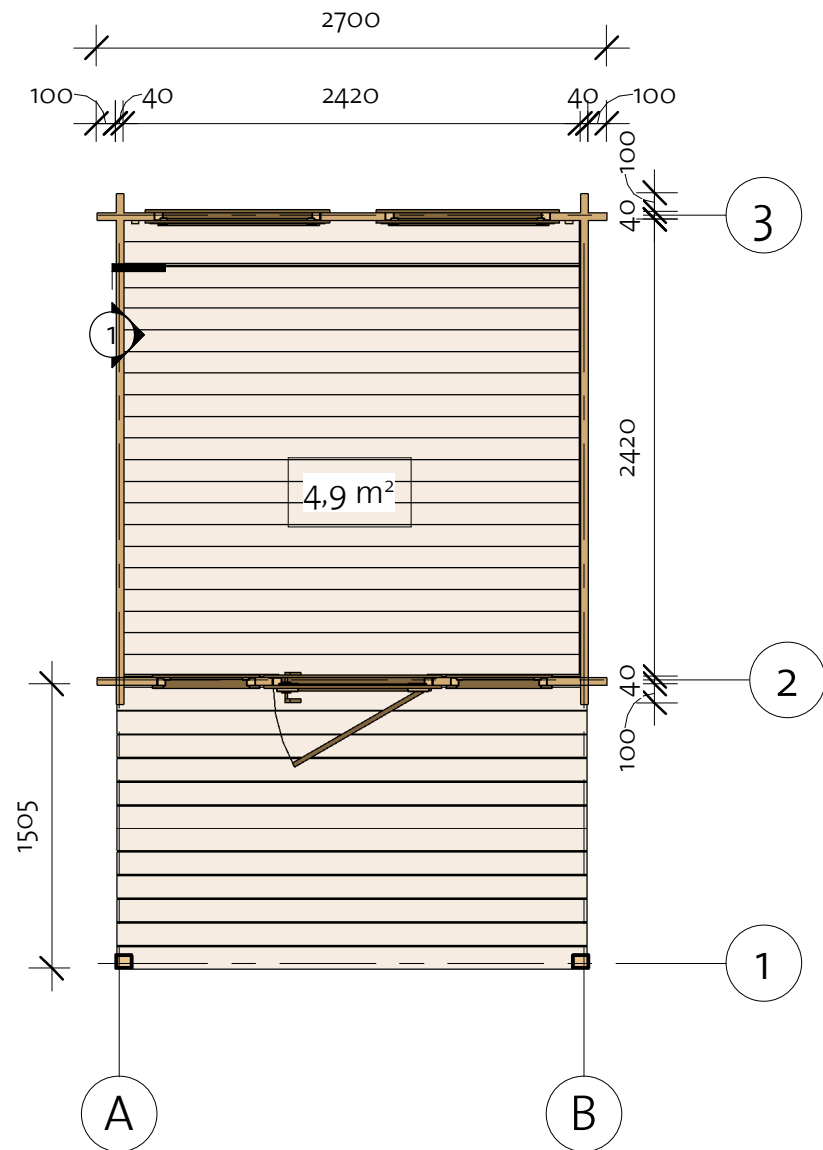

# Sauna Dockside A 40 (250x250)

Wall 1

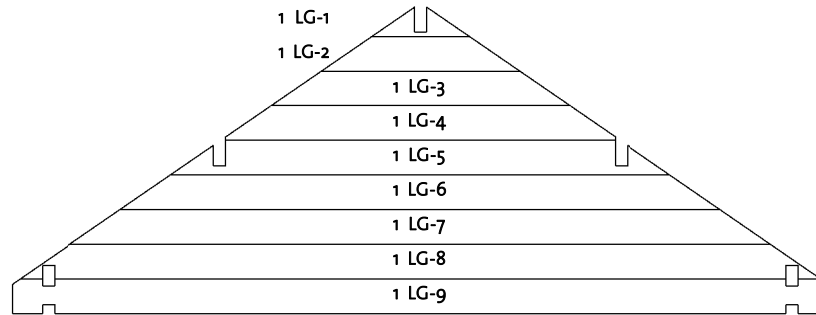
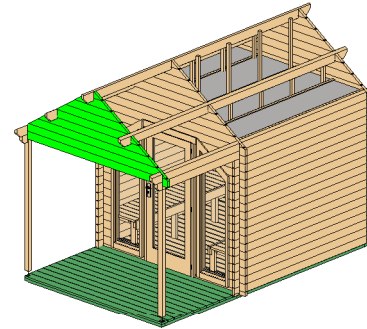

Wall 1			
Mark	Profile	Count	Cut Length

1LG-1 *	40X114	1	321
1LG-2 *	40X114	1	654
1LG-3 *	40X114	1	986
1LG-4 *	40X114	1	1287
1LG-5 *	40X114	1	1650
1LG-6 *	40X114	1	1983
1LG-7 *	40X114	1	2315
1LG-8 *	40X114	1	2647
1LG-9 *	40X114	1	2700

\* Gable - delivered premounted

Log Profile Wall 1

Profile	Profile
---------	---------

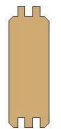

40X114



# Sauna Dockside A 40 (250x250)

Wall 2

Log Profile Wall 2	
Profile	Profile

40x57	
40x114	

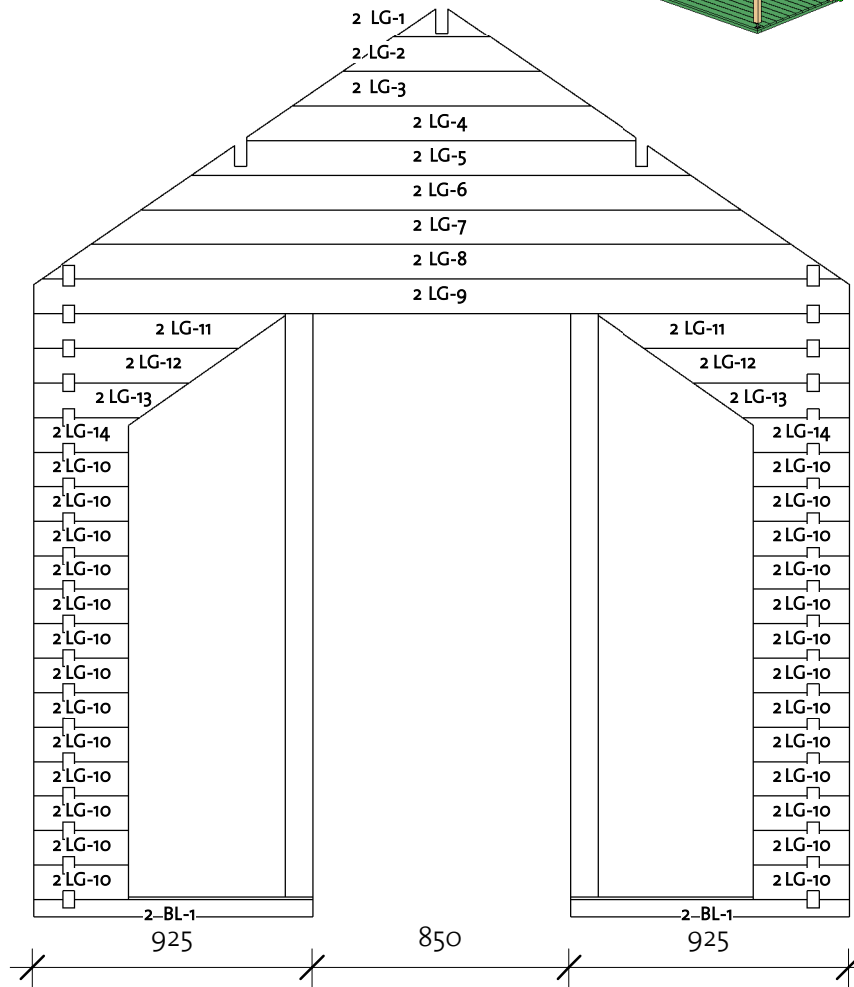
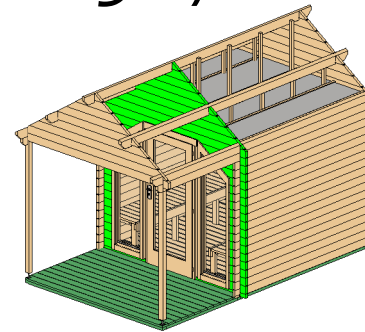

Wall 2			
Mark	Profile	Count	Cut Length

2BL-1	40x57	2	925
2LG-1 *	40x114	1	321
2LG-2 *	40x114	1	654
2LG-3 *	40x114	1	986
2LG-4 *	40x114	1	1287
2LG-5 *	40x114	1	1650
2LG-6 *	40x114	1	1983
2LG-7 *	40x114	1	2315
2LG-8 *	40x114	1	2647
2LG-9 *	40x114	1	2700
2LG-10	40x114	26	318
2LG-11	40x114	2	835
2LG-12	40x114	2	691
2LG-13	40x114	2	528
2LG-14	40x114	2	365

\* Gable - delivered premounted

Column schedule		
Type	Length	Count

Post 40x90	1930	2
------------	------	---

# Sauna Dockside A 40 (250x250)

Wall 3

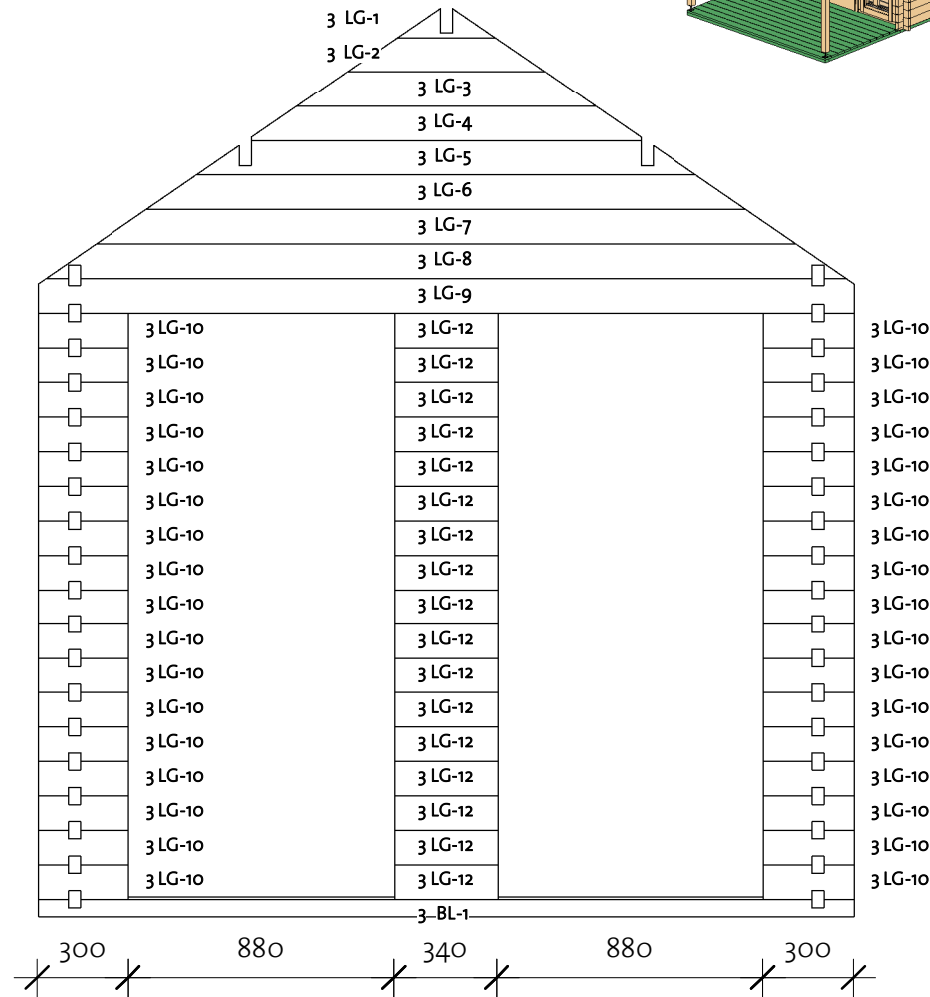
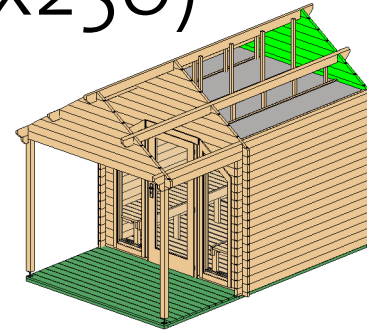



Wall 3			
Mark	Profile	Count	Cut Length

3BL-1	40X57	1	2700
3LG-1 *	40X114	1	321
3LG-2 *	40X114	1	654
3LG-3 *	40X114	1	986
3LG-4 *	40X114	1	1287
3LG-5 *	40X114	1	1650
3LG-6 *	40X114	1	1983
3LG-7 *	40X114	1	2315
3LG-8 *	40X114	1	2647
3LG-9 *	40X114	1	2700
3LG-10	40X114	34	300
3LG-12	40X114	17	340

\* Gable - delivered premounted

Log Profile Wall 3	
Profile	Profile

40X57	
40X114	

# Sauna Dockside A 40 (250x250)

Wall A

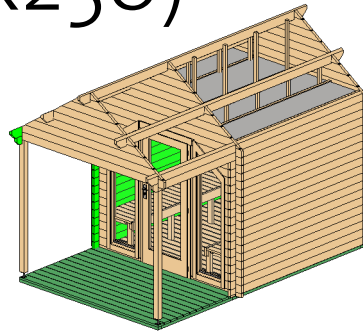

Wall A			
Mark	Profile	Count	Cut Length

ALG-1	40X114	1	4200
ALG-2	40X114	17	2700
ATL-1	40X135	1	4400

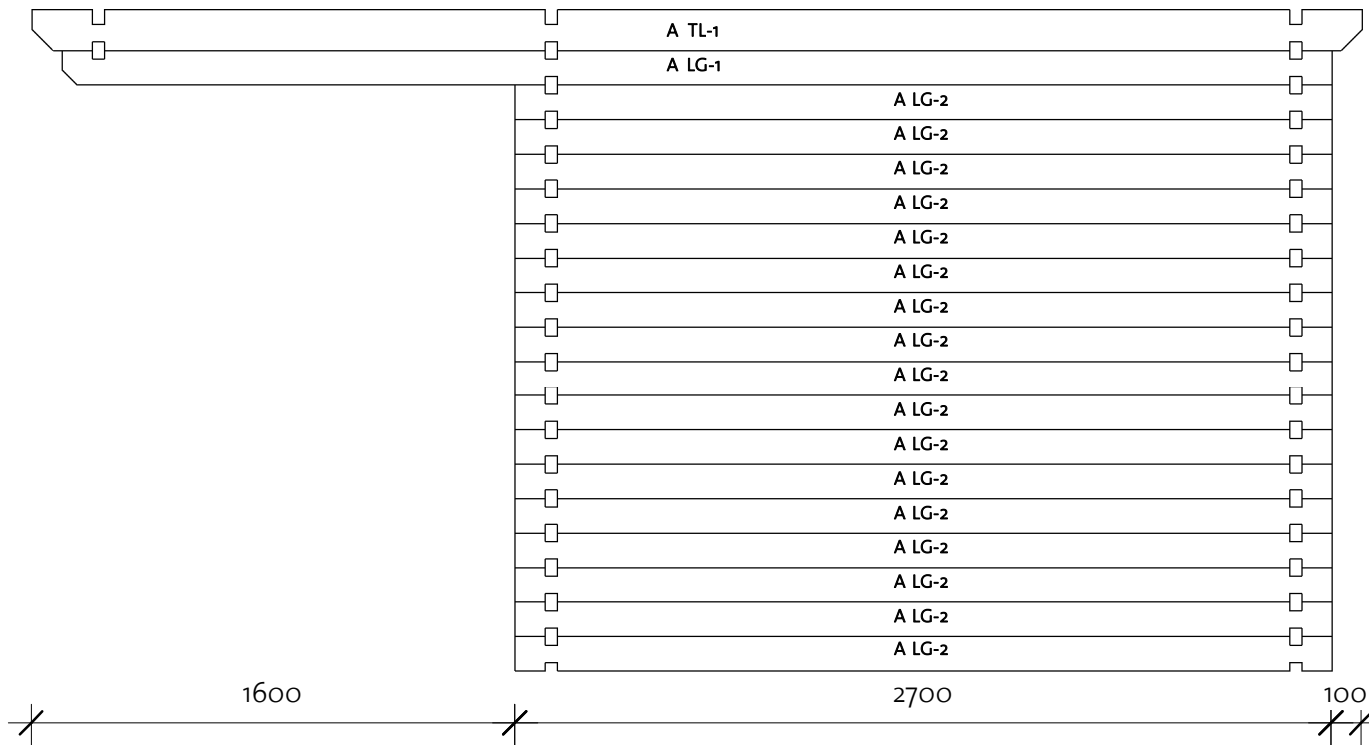

Log Profile Wall A	
Profile	Profile

40X114	
40X135	

# Sauna Dockside A 40 (250x250)

Wall B

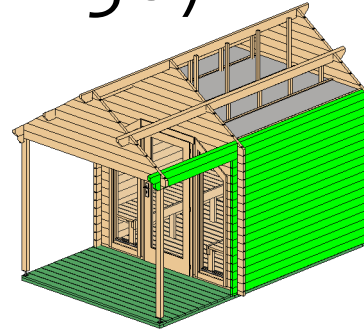

Wall B			
Mark	Profile	Count	Cut Length

BLG-1	40X114	1	4200
BLG-2	40X114	17	2700
BTL-1	40X135	1	4400

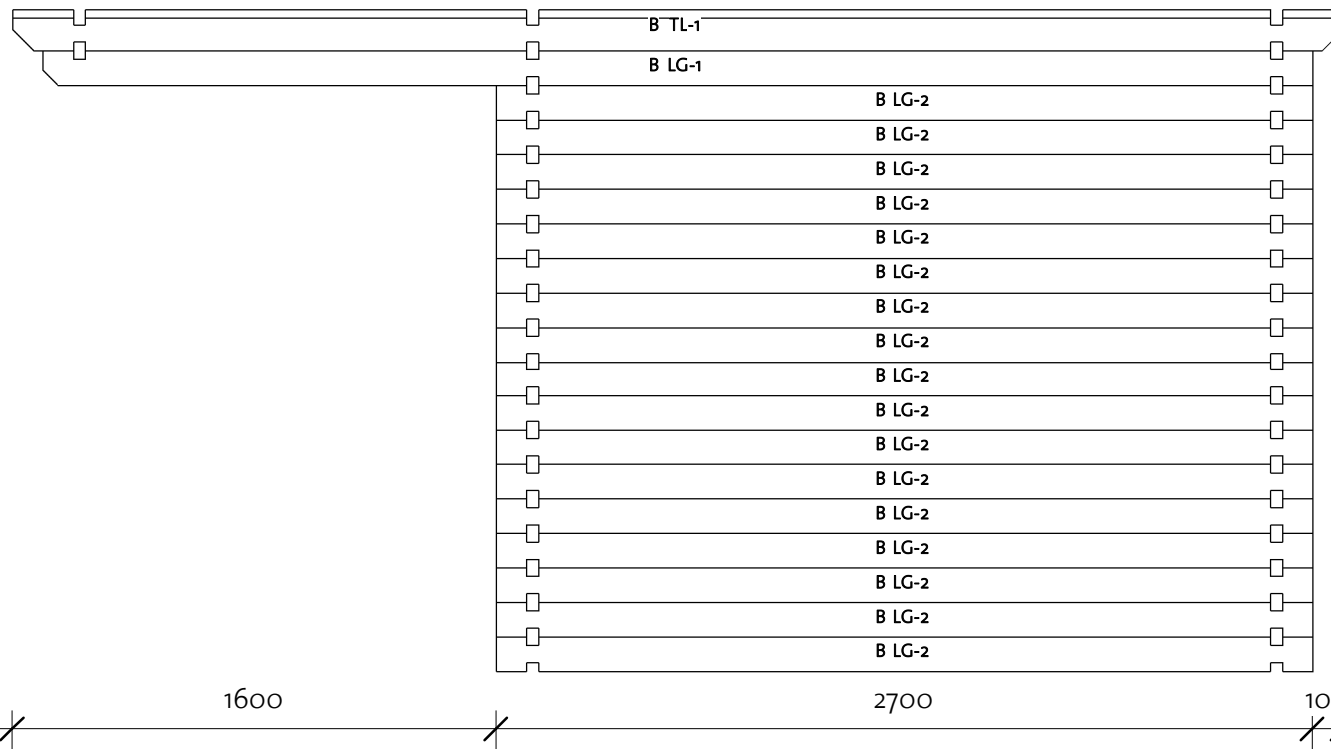

Log Profile Wall B	
Profile	Profile

40X135	
40X114	



# Sauna Dockside A 40 (250x250)

Roof 1

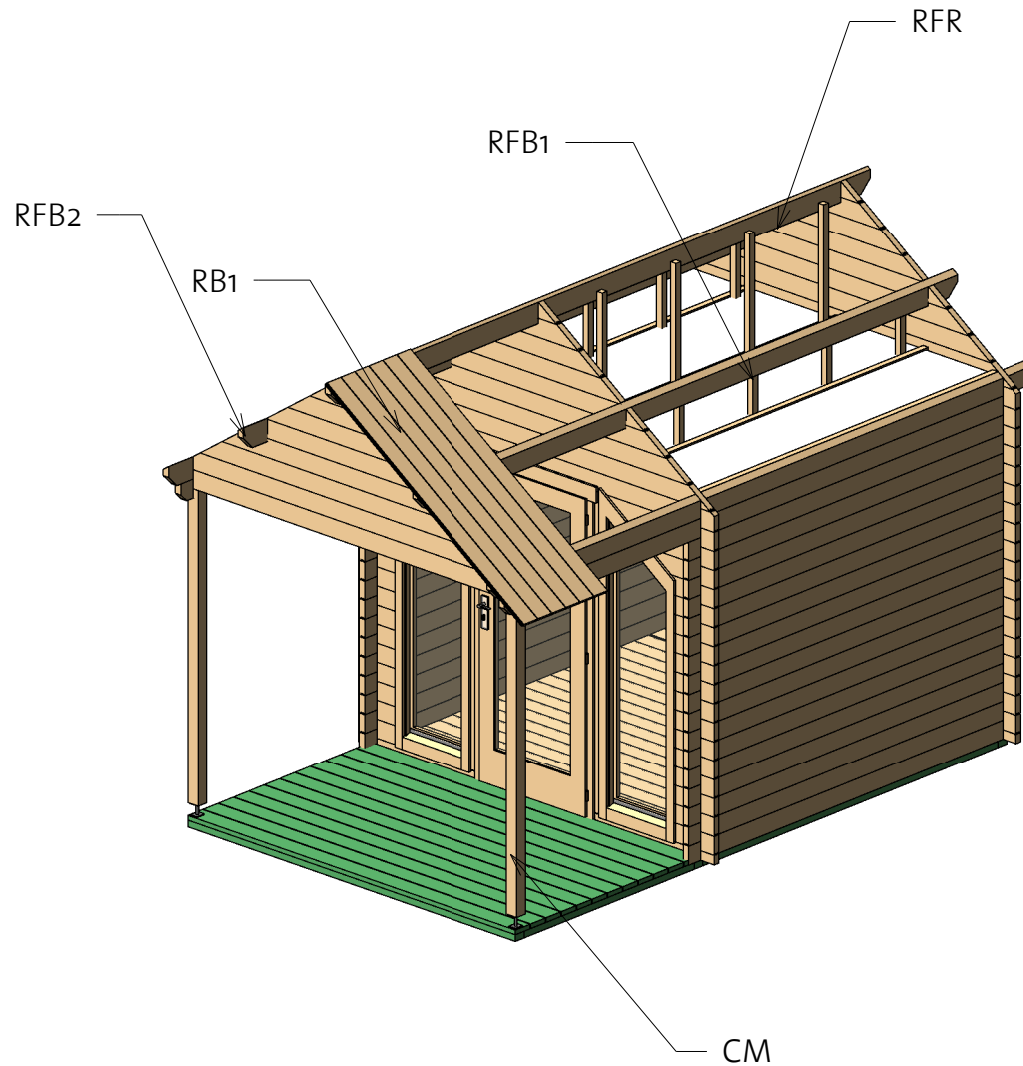

Roof				
Mark	Type	Profile	Count	Length

RB	17x114		78	1818
RFB1	Beam 40x143		1	4400
RFB2	Beam 40x143		1	4400
RFR	Ridge 40x143		1	4400

Columns			
Mark	Profile	Count	Length

CM	Post 80x70	2	1892
----	------------	---	------

# Sauna Dockside A 40 (250x250)

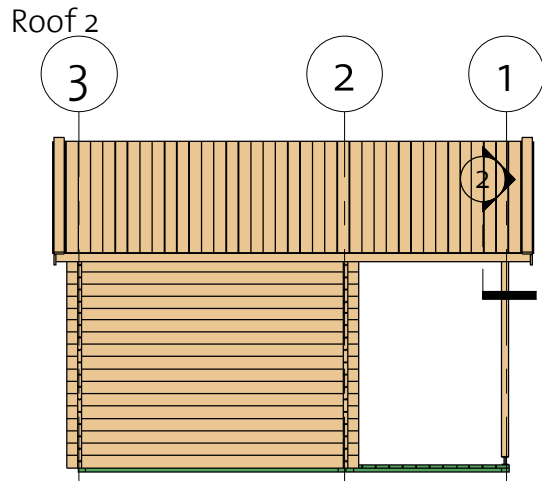

② Facia

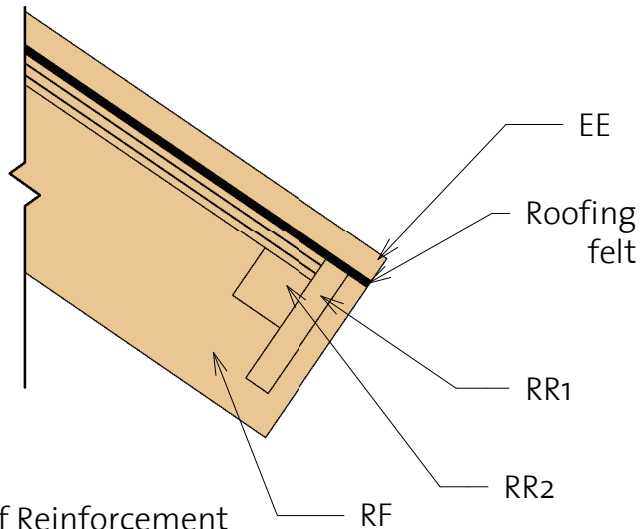

③ Roof Reinforcement

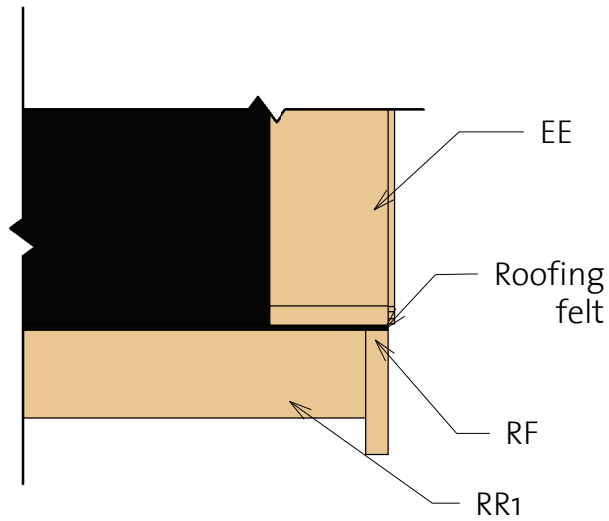
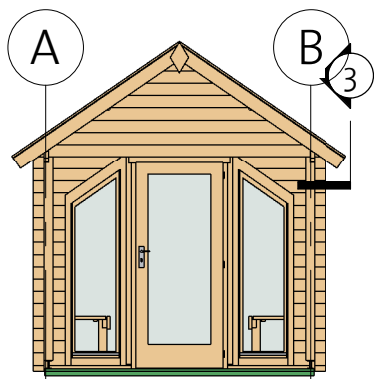



Fascia Schedule				
Mark	Type	Profile	Count	Length
EE	Eave Edging 18x95		4	1864
RF	Roof Fascia 18x120		4	1864
RR1	Roof reinforcement 18x95		2	4400
RR2	Roof reinforcement 38x38		2	4400

# Sauna Dockside A 40 (250x250)

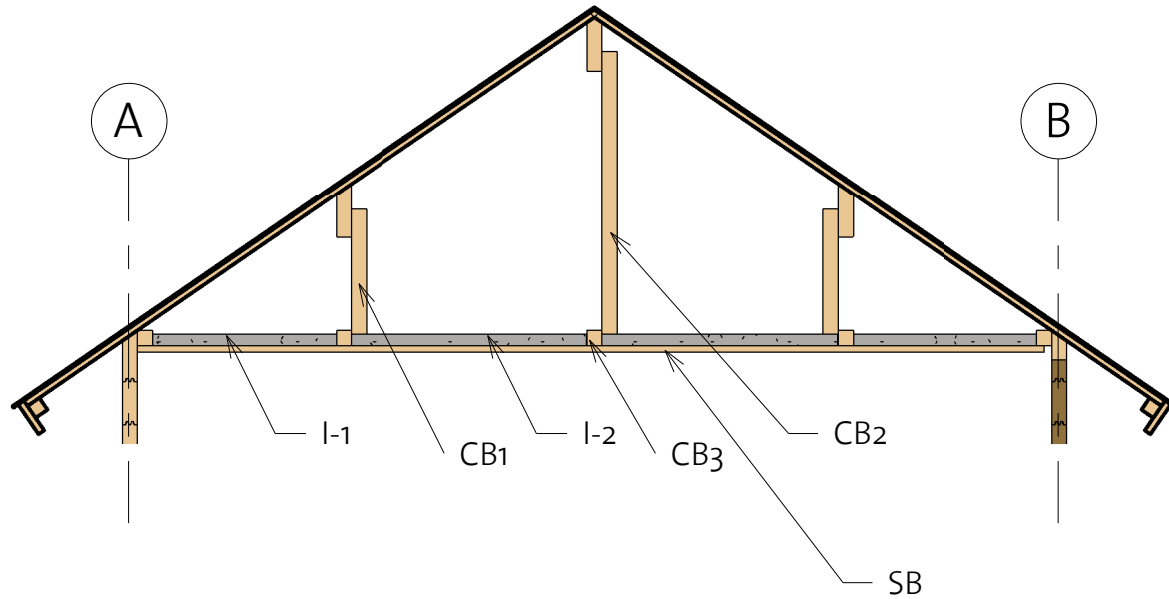
Ceiling



Ceiling Schedule

Mark	Type	Profile	Count	Length
CB1	40x40		8	360
CB2	40x40		4	780
CB3	40x40		5	2415
SB	15x80		31	2400

Insulation Schedule

Mark	Type	Count	Length
I-1	Insulation 486	2	2400
I-2	Insulation 622	2	2400

# Sauna Dockside A 40 (250x250)

Extras

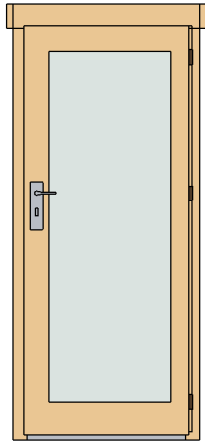

Door Schedule				
Model	Type	Width	Height	Count
CD6R	Classic door 6 right, Tempered	840	1955	1

Type	Count	Length
------	-------	--------

Windboard 18x40	4	2200
--------------------	---	------

Type	Count
------	-------

Romb	2
------	---



Fasteners/Extras		
Name	Type	Count

Hitblock	300-400 mm	
Adjustable post foot		2
Bolts	M8x70	12
Nails	1,4 x 40	25
Screws	6,0 x 140	40
Screws	5,0 x 70	50
Screws	4,0 x 40	700

Window Schedule					
Mark	Type	Width	Height	Count	

CW4R	Classic window 4, right Tempered	875	1890	2	
CW25	Classic window 25, Tempered	515	1890	1	
CW26	Classic window 26, Tempered	515	1890	1	

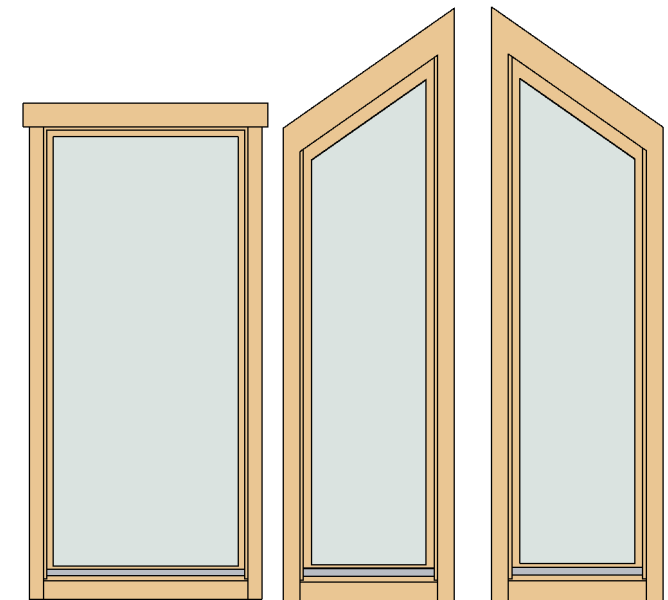

- \* Windows intended for tilt opening only!
- \* Fenster zur Eröffnung nur zum Kippen vorgesehen!
- \* Aknad on ette nähtud ainult kaldu avamiseks!





# Sauna Dockside A 40 (250x250)

## List of all items 1

### Impregnated foundation beams

Mark	Type	Profile	Count	Length
IFB1	IFB 70x40		5	2335
IFB2	IFB 70x40		4	2490
IFB3	IFB 70x40		5	1385



### Roof

Mark	Type	Profile	Count	Length
RB	17x114		78	1818
RFB1	Beam 40x143		1	4400
RFB2	Beam 40x143		1	4400
RFR	Ridge 40x143		1	4400





### Floor Schedule

Mark	Type	Profile	Count	Length
FB	FB 17x114		22	2414

### Terrace Schedule

TB	TB 28x120		12	2490
BB	BB 18x40		4	2500

### Fascia Schedule

Mark	Type	Profile	Count	Length
EE	Eave Edging 18x95		4	1864
RF	Roof Fascia 18x120		4	1864
RR1	Roof reinforce ment 18x95		2	4400
RR2	Roof reinforce ment 38x38		2	4400

# Sauna Dockside A 40 (250x250)

## List of all items 2

Wall 1			
Mark	Profile	Count	Cut Length

1LG-1 *	40X114	1	321
1LG-2 *	40X114	1	654
1LG-3 *	40X114	1	986
1LG-4 *	40X114	1	1287
1LG-5 *	40X114	1	1650
1LG-6 *	40X114	1	1983
1LG-7 *	40X114	1	2315
1LG-8 *	40X114	1	2647
1LG-9 *	40X114	1	2700

Wall 2			
Mark	Profile	Count	Cut Length

2BL-1	40X57	2	925
2LG-1 *	40X114	1	321
2LG-2 *	40X114	1	654
2LG-3 *	40X114	1	986
2LG-4 *	40X114	1	1287
2LG-5 *	40X114	1	1650
2LG-6 *	40X114	1	1983
2LG-7 *	40X114	1	2315
2LG-8 *	40X114	1	2647
2LG-9 *	40X114	1	2700
2LG-10	40X114	26	318
2LG-11	40X114	2	835
2LG-12	40X114	2	691
2LG-13	40X114	2	528
2LG-14	40X114	2	365

Wall 3			
Mark	Profile	Count	Cut Length

3BL-1 *	40X57	1	2700
3LG-1 *	40X114	1	321
3LG-2 *	40X114	1	654
3LG-3 *	40X114	1	986
3LG-4 *	40X114	1	1287
3LG-5 *	40X114	1	1650
3LG-6 *	40X114	1	1983
3LG-7 *	40X114	1	2315
3LG-8 *	40X114	1	2647
3LG-9 *	40X114	1	2700
3LG-10	40X114	34	300
3LG-12	40X114	17	340

\* Gable - delivered premounted

Wall B			
Mark	Profile	Count	Cut Length

BLG-1	40X114	1	4200
BLG-2	40X114	17	2700
BTL-1	40X135	1	4400





Wall A			
Mark	Profile	Count	Cut Length

ALG-1	40X114	1	4200
ALG-2	40X114	17	2700
ATL-1	40X135	1	4400

# Sauna Dockside A 40 (250x250)

## List of all items 3

Log profiles	
Profile	Profile

40x57	
40x135	
40x135	
40x114	

Columns			
Mark	Profile	Count	Length

CM	Post 80x70	2	1892
----	------------	---	------

Column schedule		
Type	Length	Count

Post 40x90	1930	2
------------	------	---