

Sauna Cabin B 40 (478"x117 3/8")

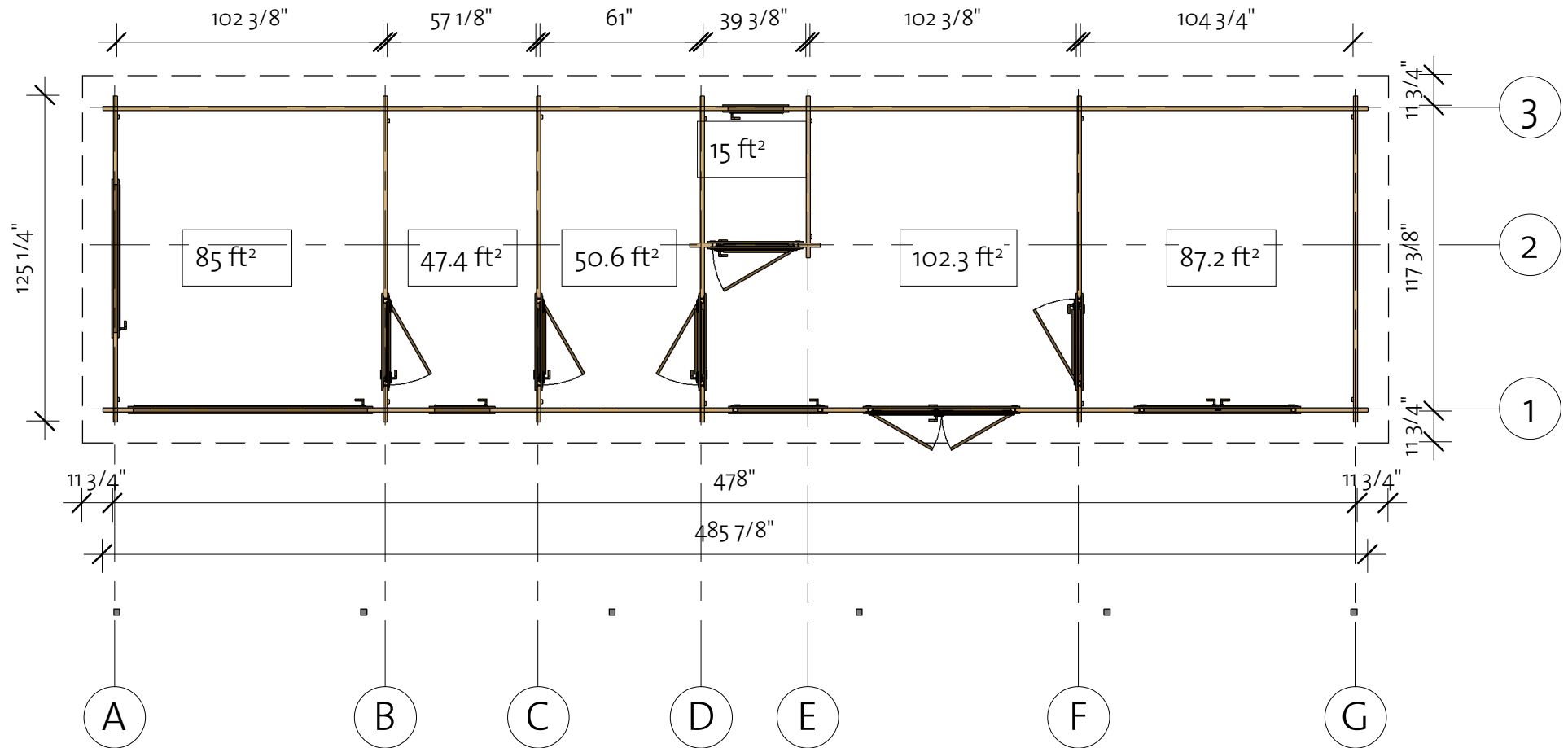

Sauna Cabin B 40 (478"x117 3/8")

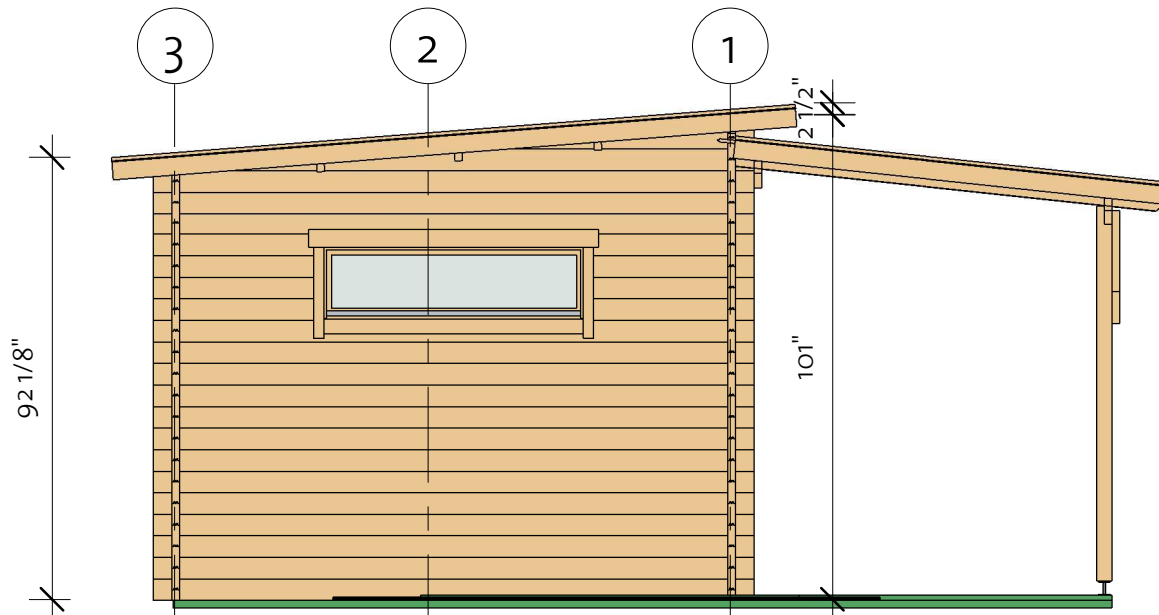

92311041_250617

Sauna Cabin B 40 (478" x 117 3/8")

Foundation

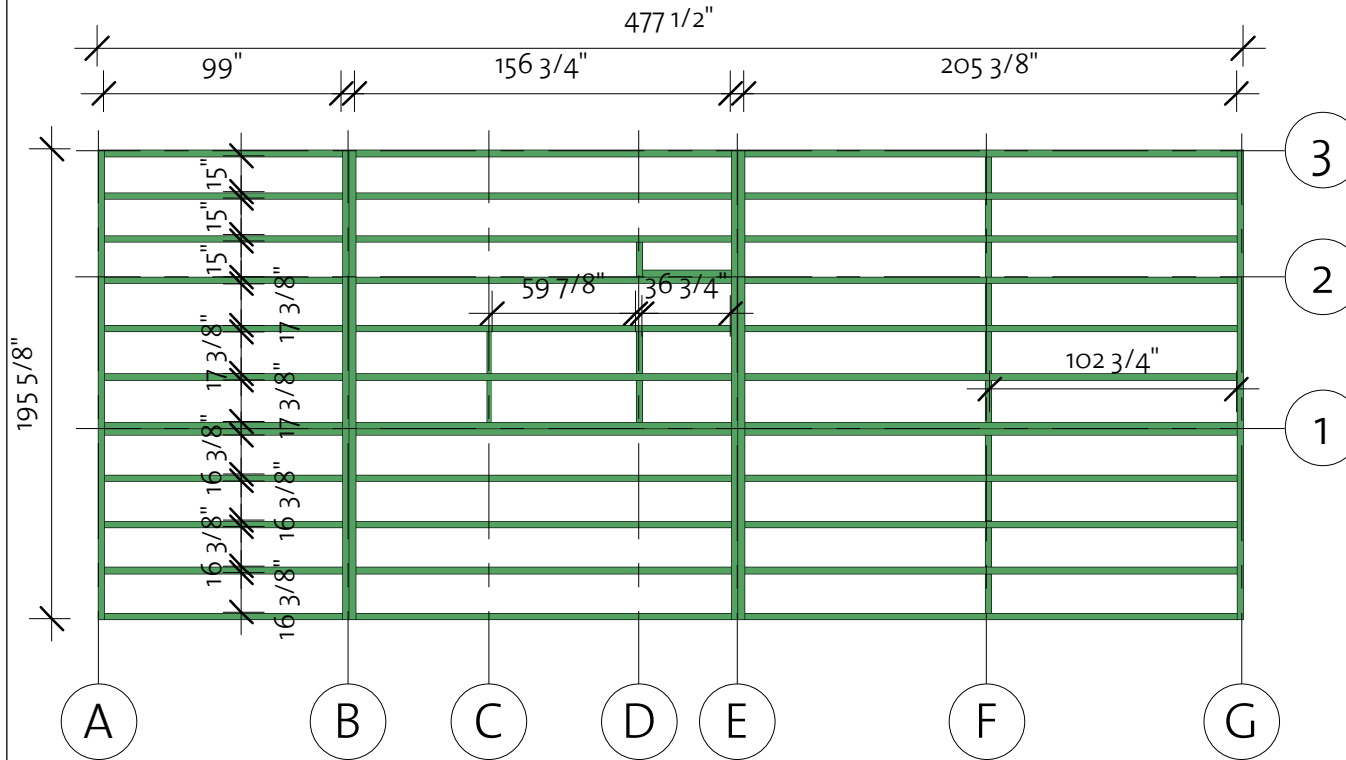

Impregnated foundation beams				
Mark	Type	Profile	Count	Length

IFB1	IFB 70x40		6	195 5/8"
IFB2	IFB 70x40		12	99"
IFB3	IFB 70x40		12	156 3/4"
IFB4	IFB 70x40		12	205 3/8"
IFB5	IFB 70x40		7	17 3/8"
IFB6	IFB 70x40		4	15"
IFB7	IFB 70x40		1	36 3/4"
IFB8	IFB 70x40		4	16 3/8"

Sauna Cabin B 40 (478" x 117 3/8")

Floor Plan ① Baseboard

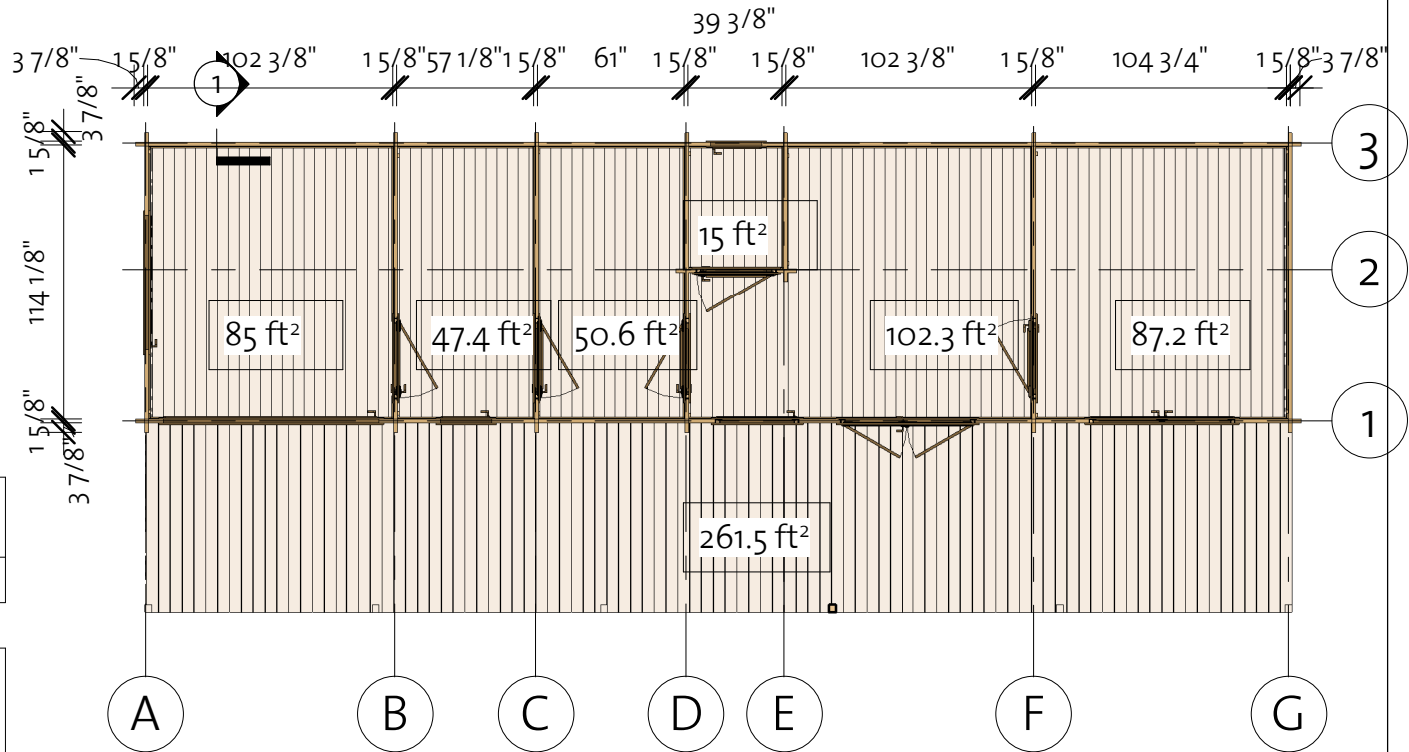
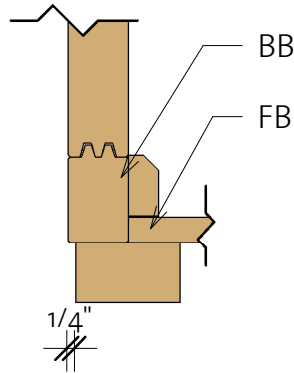

Floor Schedule

Mark	Type	Profile	Count	Length
------	------	---------	-------	--------

FB	FB 17x114		109	113 7/8"
----	-----------	--	-----	----------

BB	BB 20x40		20	118 1/8"
----	----------	--	----	----------



Terrace Schedule

Mark	Type	Profile	Count	Length
------	------	---------	-------	--------

TB	TB 28x120		98	78 1/2"
----	-----------	--	----	---------

Sauna Cabin B 40 (478" x 117 3/8")

Wall 1

Log Profile Wall 1	
Profile	Profile
40x57	
40x114	
40x114	

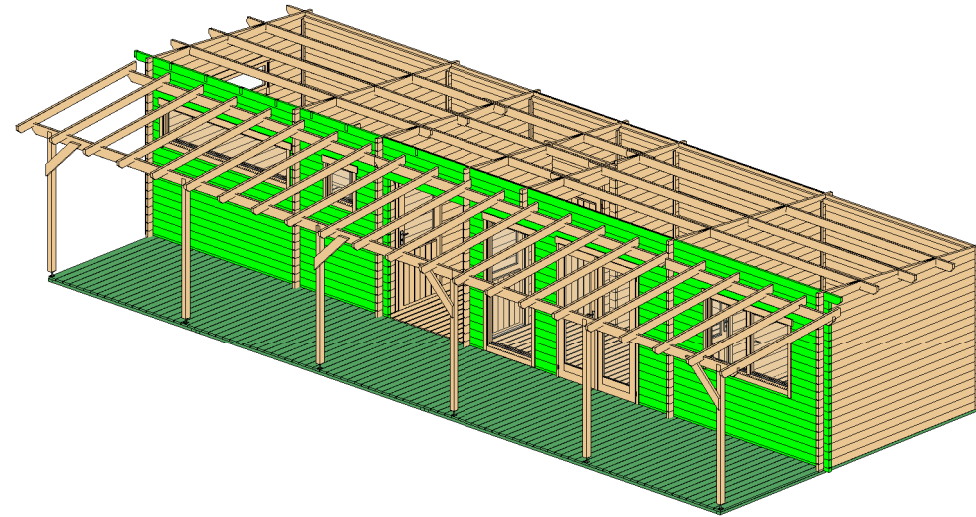

Wall 1			
Mark	Profile	Count	Cut Length

1BL-1	40x57	1	172"
1BL-2	40x57	1	16 1/2"
1BL-3	40x57	1	17 1/4"
1BL-4	40x57	1	135 3/8"
1LG-1	40x114	4	111"
1LG-2	40x114	2	207 1/2"
1LG-3	40x114	4	167 3/8"
1LG-4	40x114	1	207 1/2"
1LG-5	40x114	1	207 1/2"
1LG-6	40x114	5	11 1/2"
1LG-7	40x114	4	23 3/8"
1LG-8	40x114	1	23 3/8"
1LG-9	40x114	17	16 1/2"
1LG-10	40x114	17	17 1/4"
1LG-11	40x114	8	47 1/4"
1LG-12	40x114	1	47 1/4"
1LG-13	40x114	9	27 1/2"
1LG-14	40x114	8	135 3/8"
1LG-15	40x114	12	172"
1LG-16	40x114	5	25 3/8"
1TL-1	40x114	1	175 1/4"
1TL-2	40x114	1	207 1/2"
1TL-3	40x114	1	118 7/8"

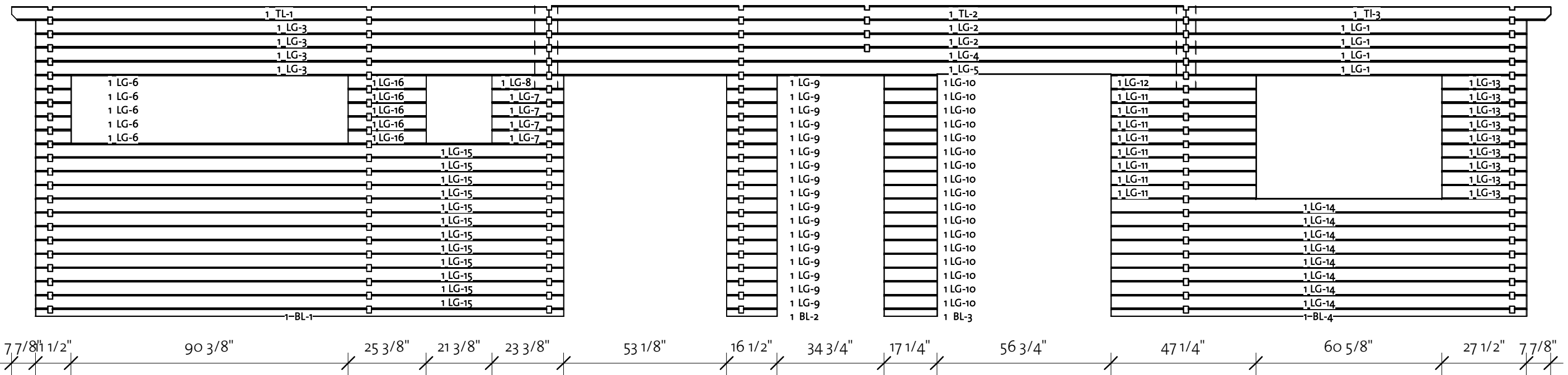

Sauna Cabin B 40 (478" x 117 3/8")

Wall 3

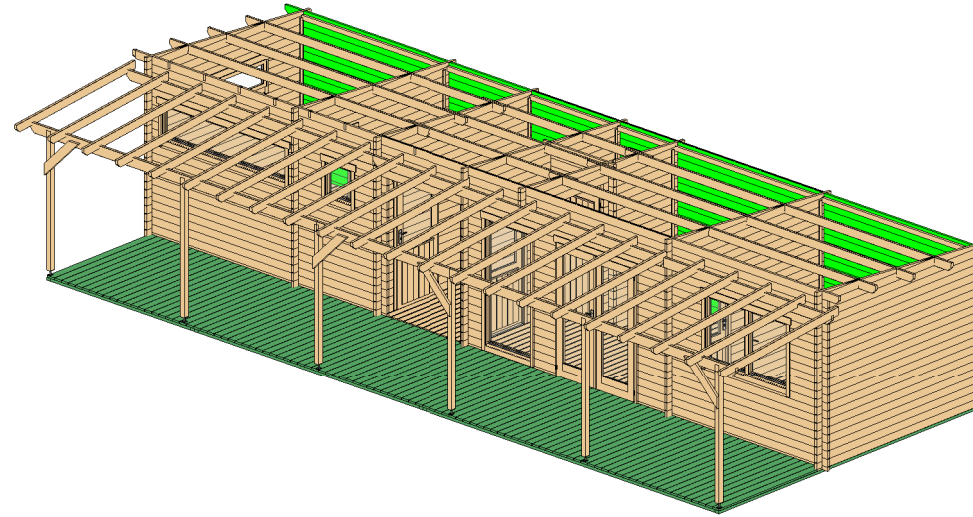

Log Profile Wall 3	
Profile	Profile

40x57	
40x104	
40x114	

Wall 3			
Mark	Profile	Count	Cut Length

3BL-1	40x57	1	167 3/8"
3BL-2	40x57	1	207 1/2"
3BL-3	40x57	1	111"
3LG-1	40x114	7	111"
3LG-2	40x114	7	207 1/2"
3LG-3	40x114	7	167 3/8"
3LG-4	40x114	7	215"
3LG-5	40x114	7	108 5/8"
3LG-6	40x114	7	162 1/4"
3LG-7	40x114	5	224 3/4"
3LG-8	40x114	5	239 5/8"
3TL-1	40x114	1	175 1/4"
3TL-2	40x114	1	207 1/2"
3TL-3	40x114	1	118 7/8"

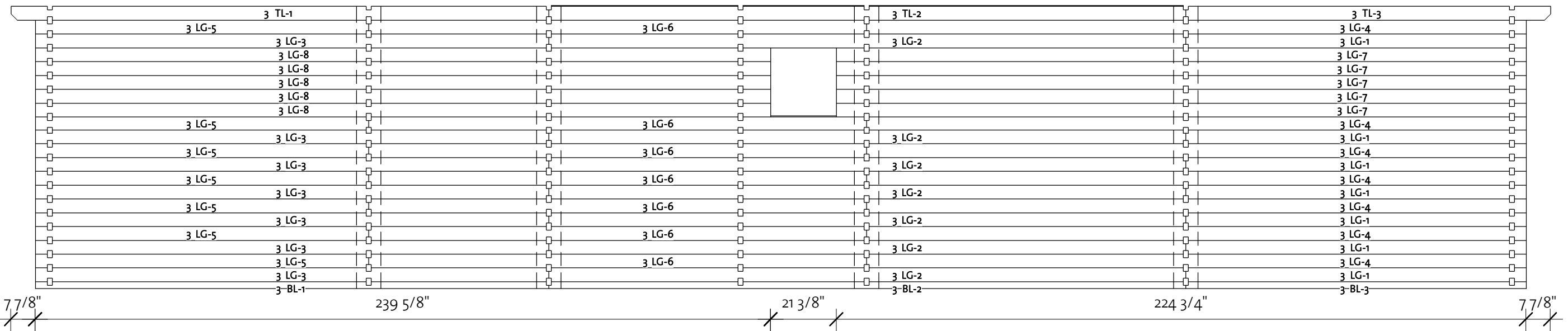

Sauna Cabin B 40 (478" x 117 3/8")

Wall C

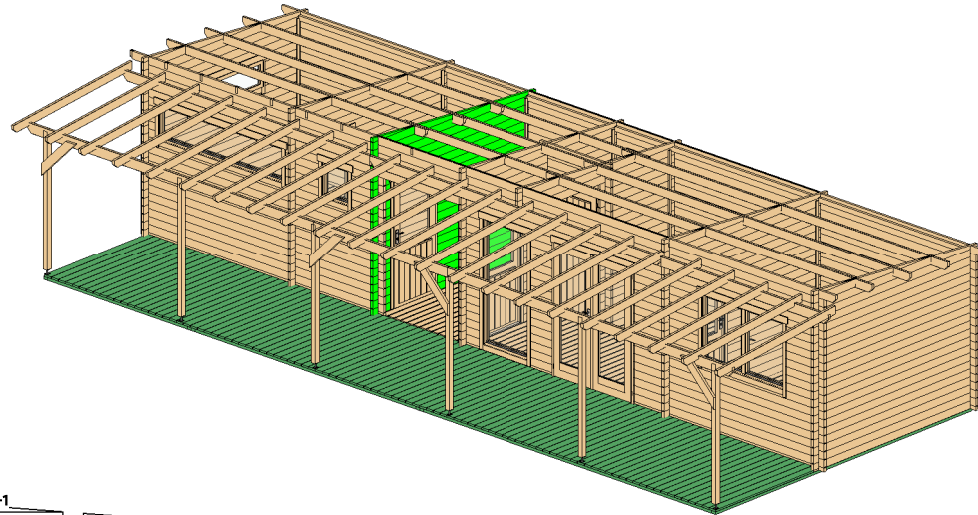

Wall C			
Mark	Profile	Count	Cut Length

CLG-1*	40X114	1	32"
CLG-2*	40X114	1	89 7/8"
CLG-3*	40X114	1	125 1/4"
CLG-4	40X114	3	125 1/4"
CLG-5	40X114	17	77 3/4"
CLG-6	40X114	17	14"

*Gable-delivered premounted

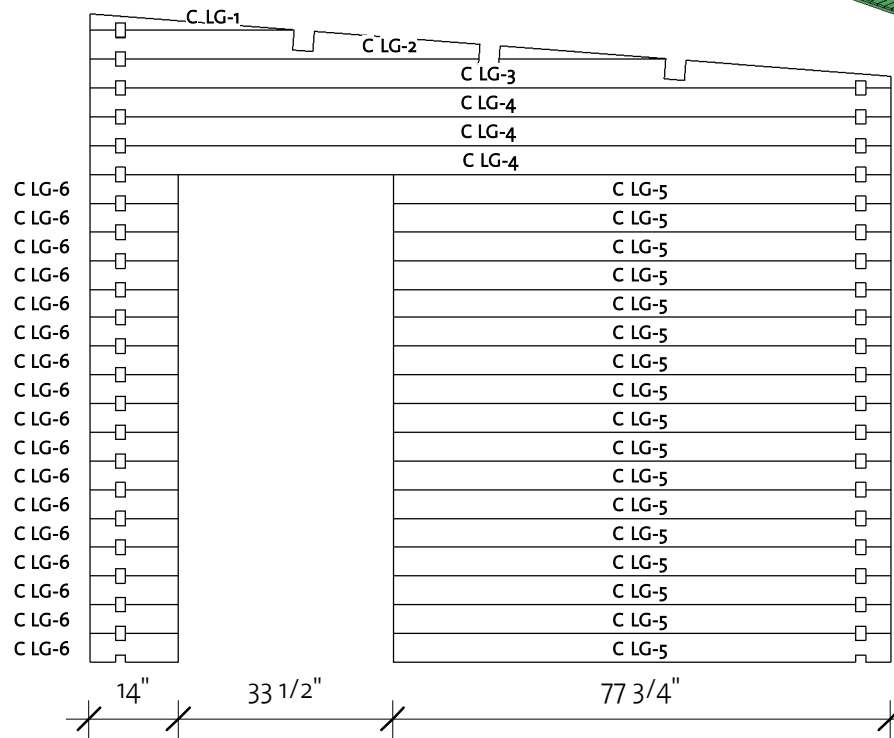

Log Profile Wall C	
Profile	Profile

40X114	
--------	--

Sauna Cabin B 40 (478" x 117 3/8")

Wall E

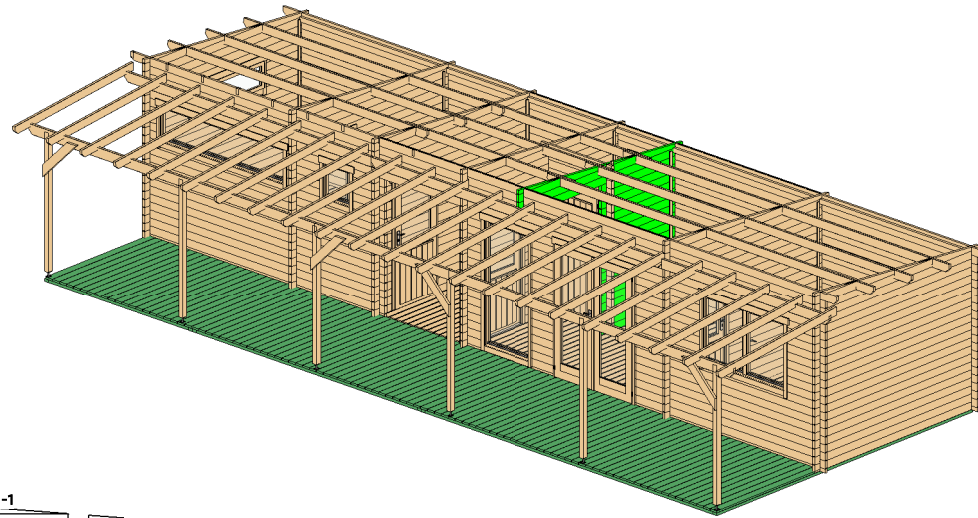

Wall E			
Mark	Profile	Count	Cut Length

ELG-1 *	40x114	1	32"
ELG-2 *	40x114	1	89 7/8"
ELG-3 *	40x114	1	125 1/4"
ELG-4	40x114	1	125 1/4"
ELG-5	40x114	19	62 1/4"

*Gable-delivered premounted

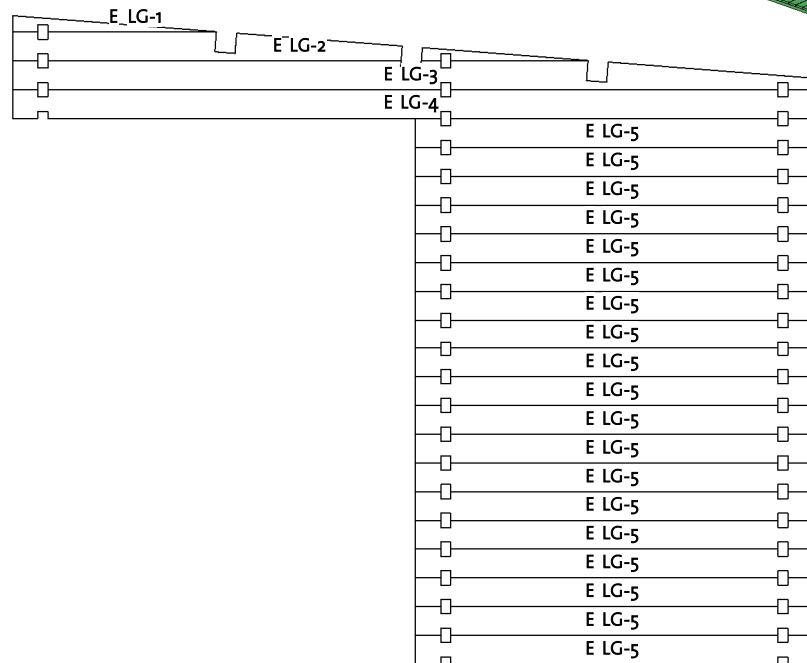

Log Profile Wall E	
Profile	Profile

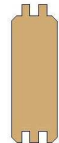
40x114	
--------	---

Sauna Cabin B 40 (478" x 117 3/8")

Wall G

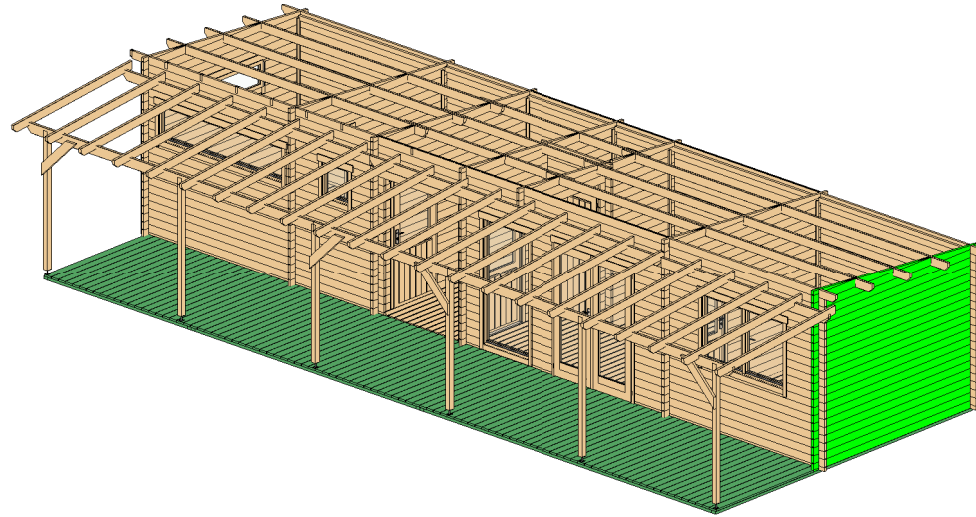

Wall G			
Mark	Profile	Count	Cut Length

GLG-1*	40x114	1	32 7/8"
GLG-2*	40x114	1	89 7/8"
GLG-3*	40x114	1	125 1/4"
GLG-4	40x114	20	125 1/4"

*Gable-delivered premounted

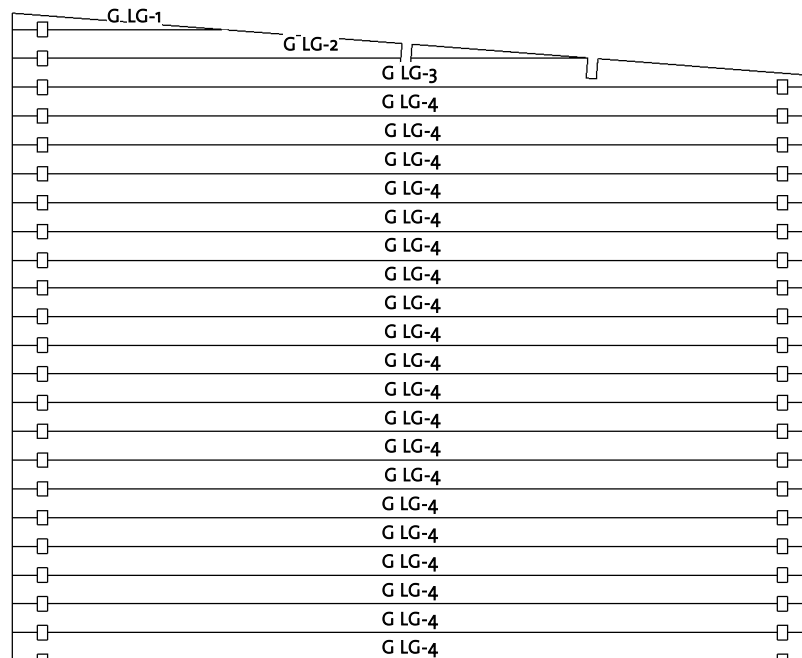

Log Profile Wall G	
Profile	Profile

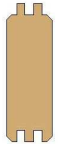
40x114	
--------	---

Sauna Cabin B 40 (478" x 117 3/8")

Roof 1

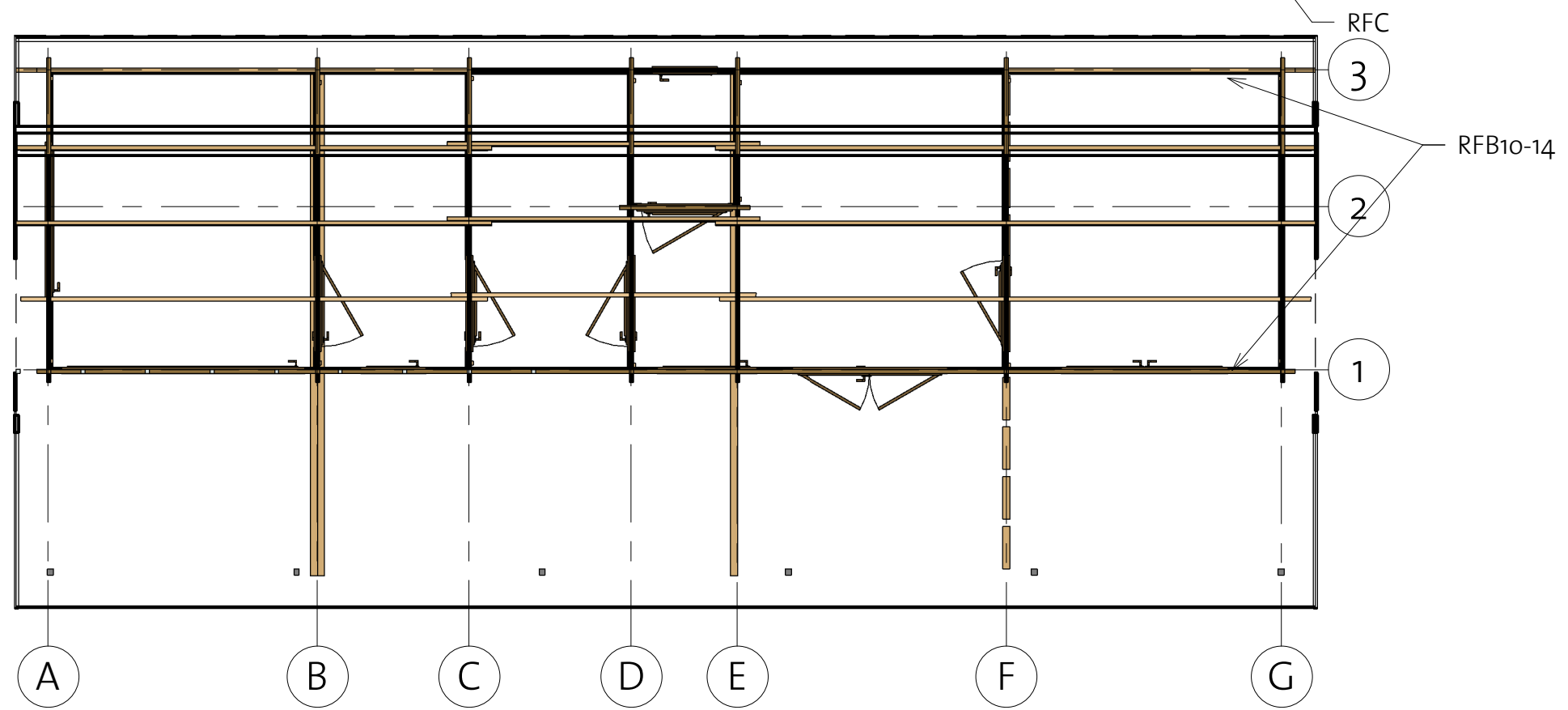
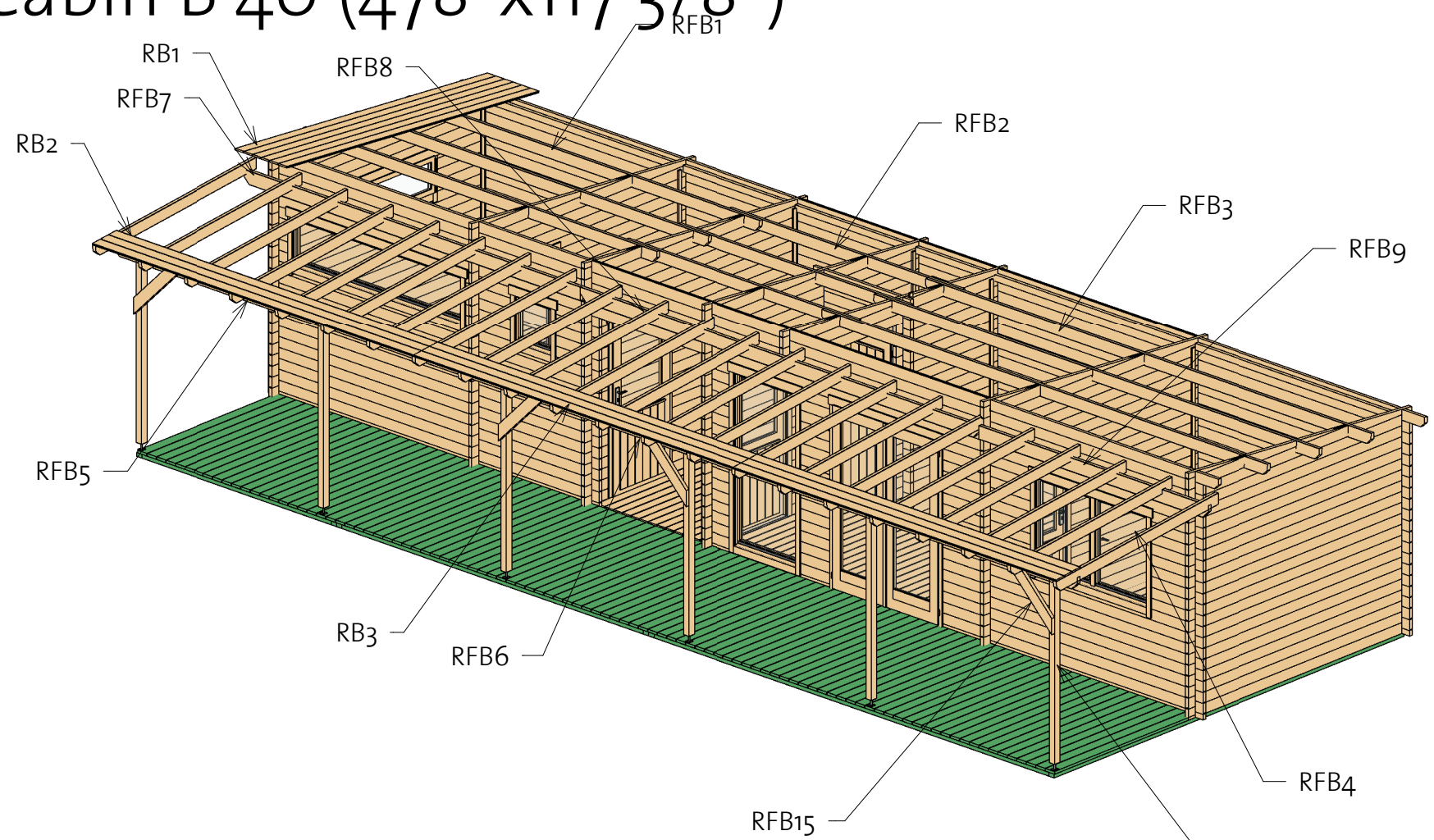

		Roof		
Mark	Type	Profile	Count	Length
RB1	17x114		114	141 1/4"
RB2	17x114		42	167 1/2"
RB3	17x114		21	166 5/8"
RB4	17x114		105	114 3/8"
RFB1	Beam 40x120		3	183 7/8"
RFB2	Beam 40x120		3	120 7/8"
RFB3	Beam 40x120		3	231 1/2"
RFB4	Beam 40x120		22	90 7/8"
RFB5	Beam 40x143		2	203 1/4"
RFB6	Beam 40x143		1	95"
RFB7	Beam 40x143		1	175 1/4"
RFB8	Beam 40x143		1	207 1/2"
RFB9	Beam 40x143		1	118 7/8"
RFB10	40x70		2	104 3/4"
RFB11	40x70		2	143 1/4"
RFB12	40x70		2	61"
RFB13	40x70		2	57 1/8"
RFB14	40x70		2	102 3/8"
RFB15	40x120		4	33 3/4"
RFC	80x70		6	78 3/8"

Sauna Cabin B 40 (478"x117 3/8")

Roof 2

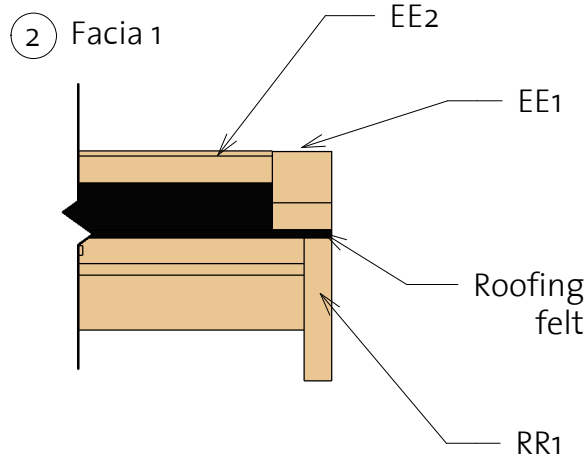
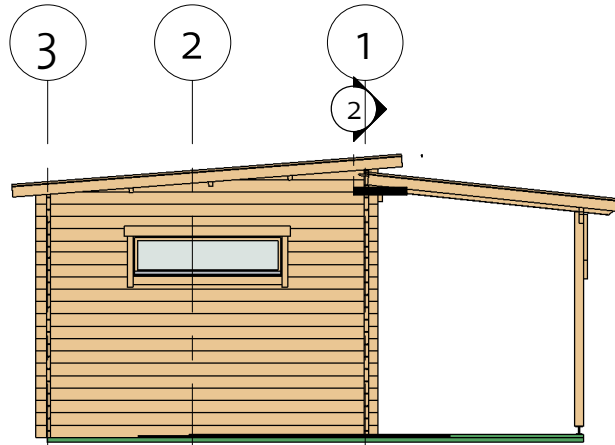

3) Facia 2

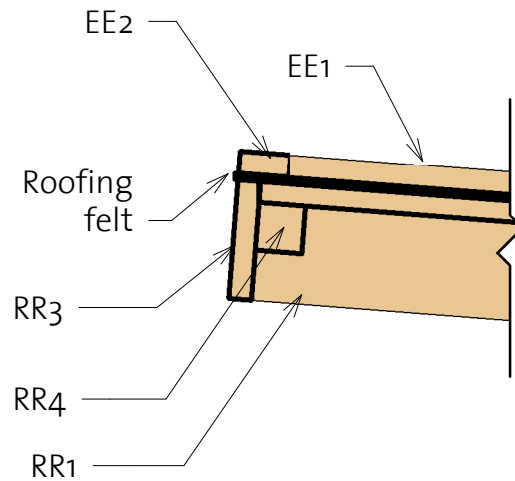

Fascia Schedule

Mark	Type	Profile	Count	Length
EE1	Eave Edging 18x40		2	142 3/4"
EE2	Eave Edging 18x40		1	499 7/8"
EE3	Eave Edging 18x40		2	91 5/8"
RR1	Roof reinforcement 18x95		2	142 3/4"
RR2	Roof reinforcement 18x95		2	91 5/8"
RR3	Roof reinforcement 18x95		3	501 5/8"
RR4	Roof reinforcement 38x38		2	501 5/8"

Sauna Cabin B 40 (478"x117 3/8")

Extras



Door Schedule				
Model	Type	Width	Height	Count
CD1L	Classic door 1 left	33 1/8"	74 3/8"	1
CD1R	Classic door 1 right	33 1/8"	74 3/8"	2
CD6R	Classic door 6 right, tempered	33 1/8"	77"	1
CD7R	Classic door 7, wood right	33 1/8"	77"	1
CDD3R	Classic double door 3 right	56 1/8"	77"	1
DB	Door beam 1440 mm	40	12	1

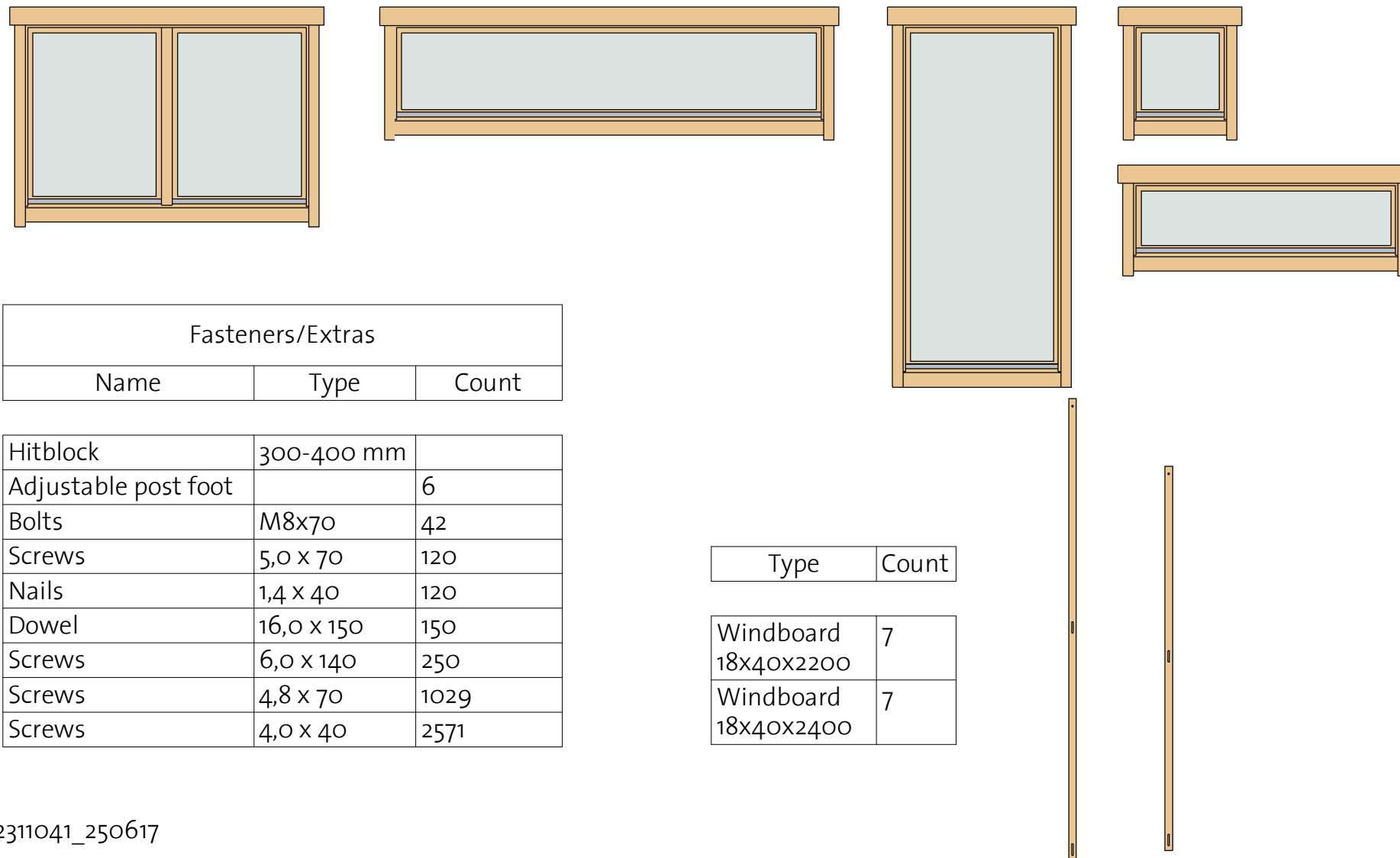

Window Schedule				
Model	Type	Width	Height	Count
CDW1	Classic double window 1	60 1/4"	39"	1
CW4R	Classic window 4 right	34 1/2"	74 3/8"	1
CW12R	Classic window 12, full glass righth	21 1/4"	21 1/4"	2
CW20R	Classic window 20 right, tempered	56 1/2"	16 1/2"	1
CW27R	Classic window 27 right	90 1/8"	21 1/4"	1

Fasteners/Extras		
Name	Type	Count

Hitblock	300-400 mm	
Adjustable post foot		6
Bolts	M8x70	42
Screws	5,0 x 70	120
Nails	1,4 x 40	120
Dowel	16,0 x 150	150
Screws	6,0 x 140	250
Screws	4,8 x 70	1029
Screws	4,0 x 40	2571

Type	Count
Windboard 18x40x2200	7
Windboard 18x40x2400	7

Sauna Cabin B 40 (478"x117 3/8")

List of all items 1

Floor Schedule

Mark	Type	Profile	Count	Length
------	------	---------	-------	--------

FB	FB 17x114		109	113 7/8"
----	-----------	---	-----	----------

BB	BB 20x40		20	118 1/8"
----	----------	---	----	----------

Terrace Schedule

Mark	Type	Profile	Count	Length
------	------	---------	-------	--------

TB	TB 28x120		98	78 1/2"
----	-----------	---	----	---------

Fascia Schedule

Mark	Type	Profile	Count	Length
------	------	---------	-------	--------

EE1	Eave Edging 18x40		2	142 3/4"
-----	-------------------	--	---	----------

EE2	Eave Edging 18x40		1	499 7/8"
-----	-------------------	--	---	----------

EE3	Eave Edging 18x40		2	91 5/8"
-----	-------------------	--	---	---------

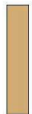
RR1	Roof reinforcement 18x95		2	142 3/4"
-----	--------------------------	---	---	----------

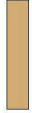
RR2	Roof reinforcement 18x95		2	91 5/8"
-----	--------------------------	---	---	---------

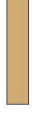
RR3	Roof reinforcement 18x95		3	501 5/8"
-----	--------------------------	---	---	----------

RR4	Roof reinforcement 38x38		2	501 5/8"
-----	--------------------------	---	---	----------

Impregnated foundation beams

Mark	Type	Profile	Count	Length
------	------	---------	-------	--------

IFB1	IFB 70x40		6	195 5/8"
------	-----------	---	---	----------

IFB2	IFB 70x40		12	99"
------	-----------	--	----	-----

IFB3	IFB 70x40		12	156 3/4"
------	-----------	--	----	----------

IFB4	IFB 70x40		12	205 3/8"
------	-----------	--	----	----------

IFB5	IFB 70x40		7	17 3/8"
------	-----------	--	---	---------

IFB6	IFB 70x40		4	15"
------	-----------	--	---	-----

IFB7	IFB 70x40		1	36 3/4"
------	-----------	--	---	---------

IFB8	IFB 70x40		4	16 3/8"
------	-----------	--	---	---------

Roof

Mark	Type	Profile	Count	Length
------	------	---------	-------	--------

RB1	17x114		114	141 1/4"
-----	--------	---	-----	----------

RB2	17x114		42	167 1/2"
-----	--------	--	----	----------

RB3	17x114		21	166 5/8"
-----	--------	--	----	----------

RB4	17x114		105	114 3/8"
-----	--------	--	-----	----------

RFB1	Beam 40x120		3	183 7/8"
------	-------------	---	---	----------

RFB2	Beam 40x120		3	120 7/8"
------	-------------	--	---	----------

RFB3	Beam 40x120		3	231 1/2"
------	-------------	--	---	----------

RFB4	Beam 40x120		22	90 7/8"
------	-------------	--	----	---------

RFB5	Beam 40x143		2	203 1/4"
------	-------------	--	---	----------

RFB6	Beam 40x143		1	95"
------	-------------	--	---	-----

RFB7	Beam 40x143		1	175 1/4"
------	-------------	--	---	----------

RFB8	Beam 40x143		1	207 1/2"
------	-------------	--	---	----------

RFB9	Beam 40x143		1	118 7/8"
------	-------------	--	---	----------

RFB10	40x70		2	104 3/4"
-------	-------	--	---	----------

RFB11	40x70		2	143 1/4"
-------	-------	--	---	----------

RFB12	40x70		2	61"
-------	-------	--	---	-----

RFB13	40x70		2	57 1/8"
-------	-------	--	---	---------

RFB14	40x70		2	102 3/8"
-------	-------	--	---	----------

RFB15	40x120		4	33 3/4"
-------	--------	--	---	---------

RFC	80x70		6	78 3/8"
-----	-------	--	---	---------

Sauna Cabin B 40 (478"x117 3/8")

List of all items 2

Wall A			
Mark	Profile	Count	Cut Length

ALG-1*	40x114	1	32"
ALG-2*	40x114	1	89 7/8"
ALG-3*	40x114	1	125 1/4"
ALG-4	40x114	16	125 1/4"
ALG-5	40x114	8	34 1/8"

Wall B			
Mark	Profile	Count	Cut Length

BLG-1*	40x114	1	32"
BLG-2*	40x114	1	89 7/8"
BLG-3*	40x114	1	125 1/4"
BLG-4	40x114	3	125 1/4"
BLG-5	40x114	17	77 3/4"
BLG-6	40x114	17	14"

Wall C			
Mark	Profile	Count	Cut Length

CLG-1*	40x114	1	32"
CLG-2*	40x114	1	89 7/8"
CLG-3*	40x114	1	125 1/4"
CLG-4	40x114	3	125 1/4"
CLG-5	40x114	17	77 3/4"
CLG-6	40x114	17	14"

Wall D			
Mark	Profile	Count	Cut Length

DLG-1*	40x114	1	32 7/8"
DLG-2*	40x114	1	90 3/4"
DLG-3*	40x114	1	125 1/4"
DLG-4	40x114	3	125 1/4"
DLG-5	40x114	17	77 3/4"
DLG-6	40x114	17	14"

Wall E			
Mark	Profile	Count	Cut Length

ELG-1*	40x114	1	32"
ELG-2*	40x114	1	89 7/8"
ELG-3*	40x114	1	125 1/4"
ELG-4	40x114	1	125 1/4"
ELG-5	40x114	19	62 1/4"

Wall F			
Mark	Profile	Count	Cut Length

FLG-1*	40x114	1	32"
FLG-2*	40x114	1	89 7/8"
FLG-3*	40x114	1	125 1/4"
FLG-4	40x114	3	125 1/4"
FLG-5	40x114	17	77 3/4"
FLG-6	40x114	17	14"

Wall G			
Mark	Profile	Count	Cut Length

GLG-1*	40x114	1	32 7/8"
GLG-2*	40x114	1	89 7/8"
GLG-3*	40x114	1	125 1/4"
GLG-4	40x114	20	125 1/4"

*Gable-delivered premounted

Wall 1			
Mark	Profile	Count	Cut Length

1BL-1	40x57	1	172"
1BL-2	40x57	1	16 1/2"
1BL-3	40x57	1	17 1/4"
1BL-4	40x57	1	135 3/8"
1LG-1	40x114	4	111"
1LG-2	40x114	2	207 1/2"
1LG-3	40x114	4	167 3/8"
1LG-4	40x114	1	207 1/2"
1LG-5	40x114	1	207 1/2"
1LG-6	40x114	5	11 1/2"
1LG-7	40x114	4	23 3/8"
1LG-8	40x114	1	23 3/8"
1LG-9	40x114	17	16 1/2"
1LG-10	40x114	17	17 1/4"
1LG-11	40x114	8	47 1/4"
1LG-12	40x114	1	47 1/4"
1LG-13	40x114	9	27 1/2"
1LG-14	40x114	8	135 3/8"
1LG-15	40x114	12	172"
1LG-16	40x114	5	25 3/8"
1TL-1	40x114	1	175 1/4"
1TL-2	40x114	1	207 1/2"
1TL-3	40x114	1	118 7/8"

Wall 2			
Mark	Profile	Count	Cut Length

2BL-1	40x57	2	8 1/2"
2LG-1	40x114	34	8 1/2"
2LG-2	40x114	3	50 3/8"
2TL-1	40x104	1	50 3/8"

Wall 3			
Mark	Profile	Count	Cut Length

3BL-1	40x57	1	167 3/8"
3BL-2	40x57	1	207 1/2"
3BL-3	40x57	1	111"
3LG-1	40x114	7	111"
3LG-2	40x114	7	207 1/2"
3LG-3	40x114	7	167 3/8"
3LG-4	40x114	7	215"
3LG-5	40x114	7	108 5/8"
3LG-6	40x114	7	162 1/4"
3LG-7	40x114	5	224 3/4"
3LG-8	40x114	5	239 5/8"
3TL-1	40x114	1	175 1/4"
3TL-2	40x114	1	207 1/2"
3TL-3	40x114	1	118 7/8"

Log profiles	
Profile	Profile

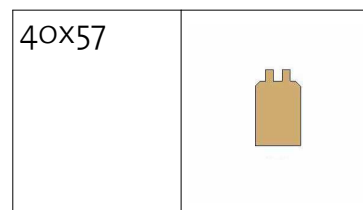

Log profiles	
Profile	Profile

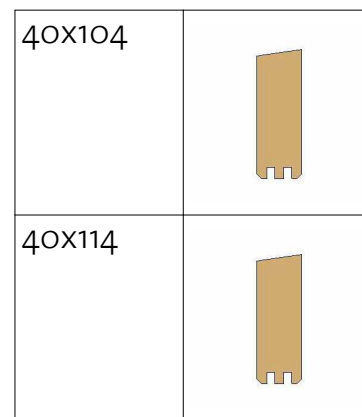

Log profiles	
Profile	Profile

