

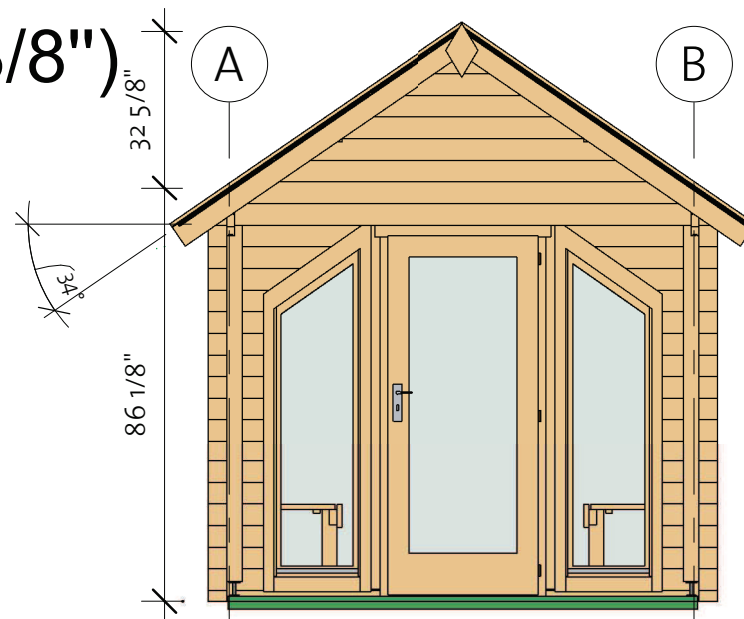

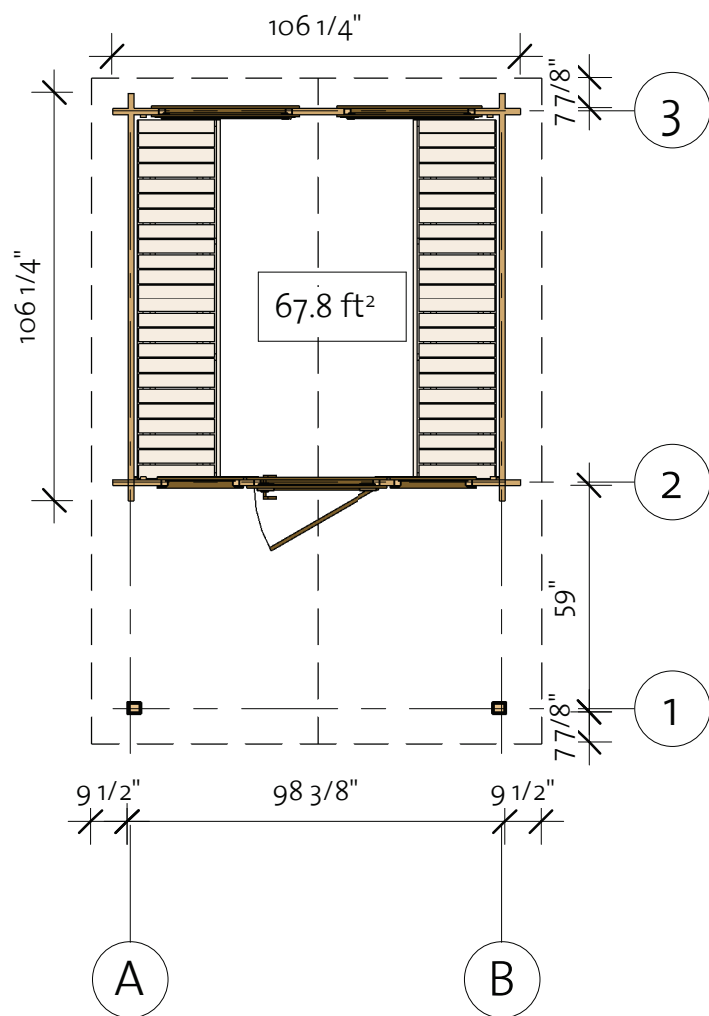

# Sauna Docksider A 40 (98 3/8"x98 3/8")

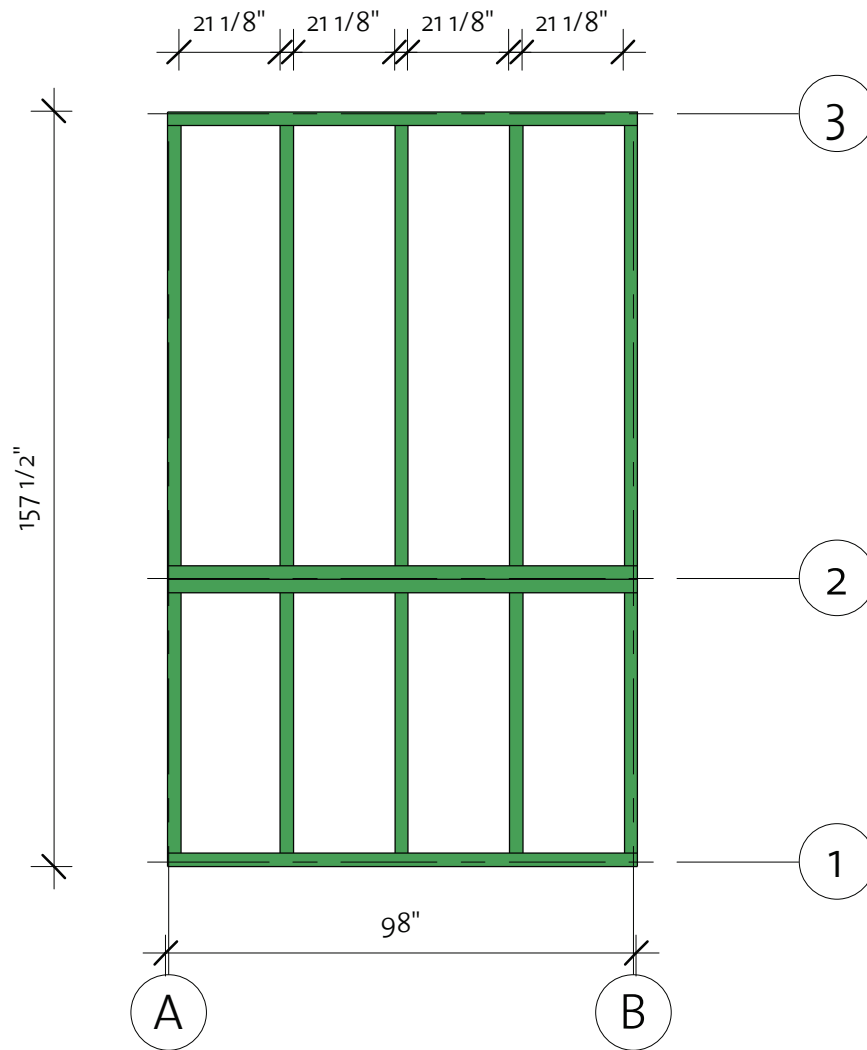

# Sauna Dockside A 40 (98 3/8"x98 3/8")

Foundation



Impregnated foundation beams				
Mark	Type	Profile	Count	Length
IFB1	IFB 70x40		5	91 7/8"
IFB2	IFB 70x40		4	98"
IFB3	IFB 70x40		5	54 1/2"

# Sauna Dockside A 40 (98 3/8"x98 3/8")

Floor Plan

① Baseboard

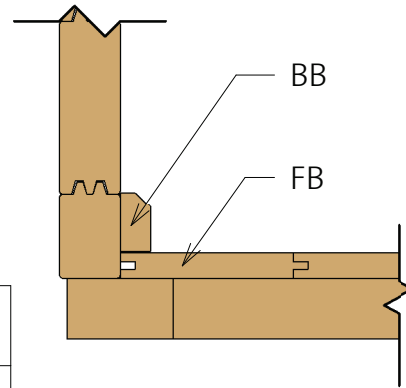

Floor Schedule				
Mark	Type	Profile	Count	Length

FB	FB 17x114		22	95"
----	-----------	---	----	-----

Terrace Schedule				
Mark	Type	Profile	Count	Length

TB	TB 28x120		12	98"
----	-----------	---	----	-----

BB	BB 18x40		4	98 3/8"
----	----------	---	---	---------

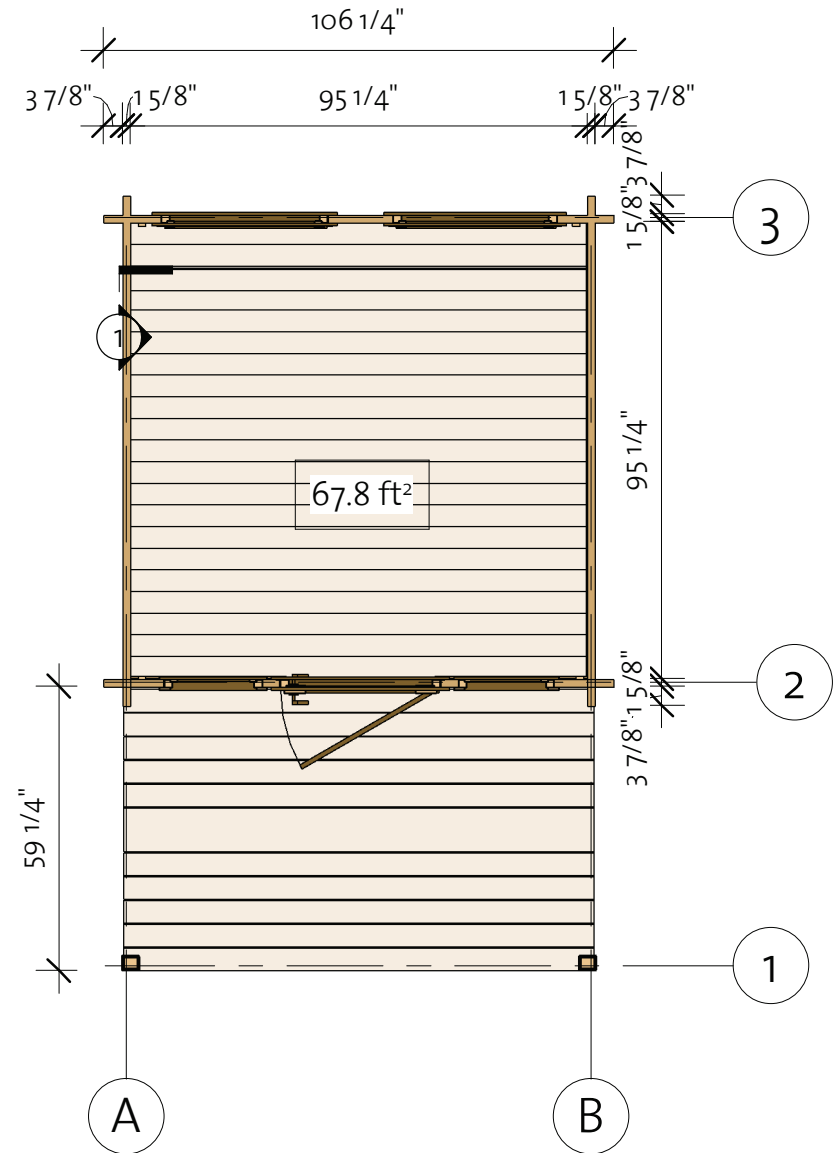

# Sauna Dockside A 40 (98 3/8"x98 3/8")

Wall 1

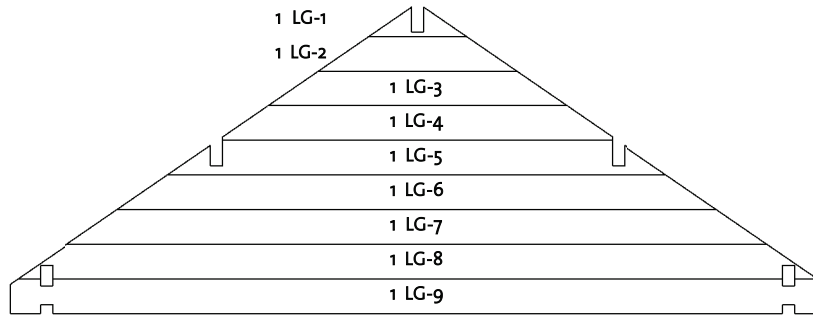
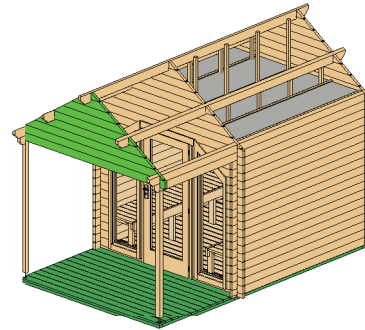

Wall 1			
Mark	Profile	Count	Cut Length

1LG-1 *	40X114	1	12 5/8"
1LG-2 *	40X114	1	25 3/4"
1LG-3 *	40X114	1	38 7/8"
1LG-4 *	40X114	1	50 5/8"
1LG-5 *	40X114	1	65"
1LG-6 *	40X114	1	78"
1LG-7 *	40X114	1	91 1/8"
1LG-8 *	40X114	1	104 1/4"
1LG-9 *	40X114	1	106 1/4"

\* Gable - delivered premounted

Log Profile Wall 1

Profile	Profile
---------	---------



40X114



# Sauna Dockside A 40 (98 3/8"x98 3/8")

Wall 2

Log Profile Wall 2	
Profile	Profile

40x57	
40x114	

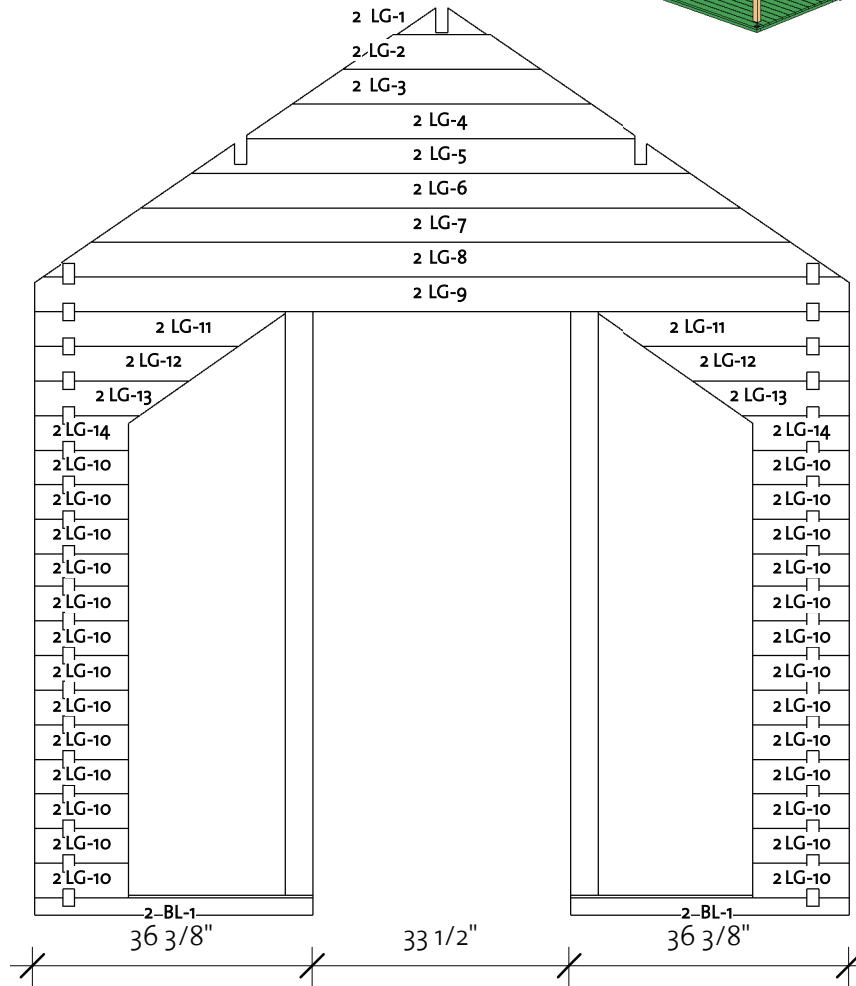
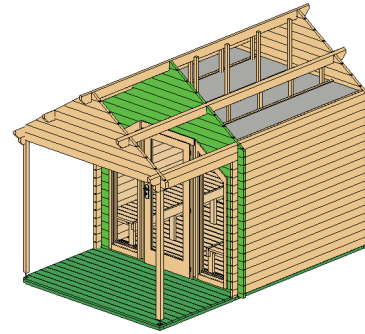

Wall 2			
Mark	Profile	Count	Cut Length

2BL-1	40x57	2	36 3/8"
2LG-1 *	40x114	1	12 5/8"
2LG-2 *	40x114	1	25 3/4"
2LG-3 *	40x114	1	38 7/8"
2LG-4 *	40x114	1	50 5/8"
2LG-5 *	40x114	1	65"
2LG-6 *	40x114	1	78"
2LG-7 *	40x114	1	91 1/8"
2LG-8 *	40x114	1	104 1/4"
2LG-9 *	40x114	1	106 1/4"
2LG-10	40x114	26	12 1/2"
2LG-11	40x114	2	32 7/8"
2LG-12	40x114	2	27 1/4"
2LG-13	40x114	2	20 3/4"
2LG-14	40x114	2	14 3/8"

\* Gable - delivered premounted

Column schedule		
Type	Length	Count

Post 40x90	76"	2
------------	-----	---

# Sauna Dockside A 40 (98 3/8"x98 3/8")

Wall 3

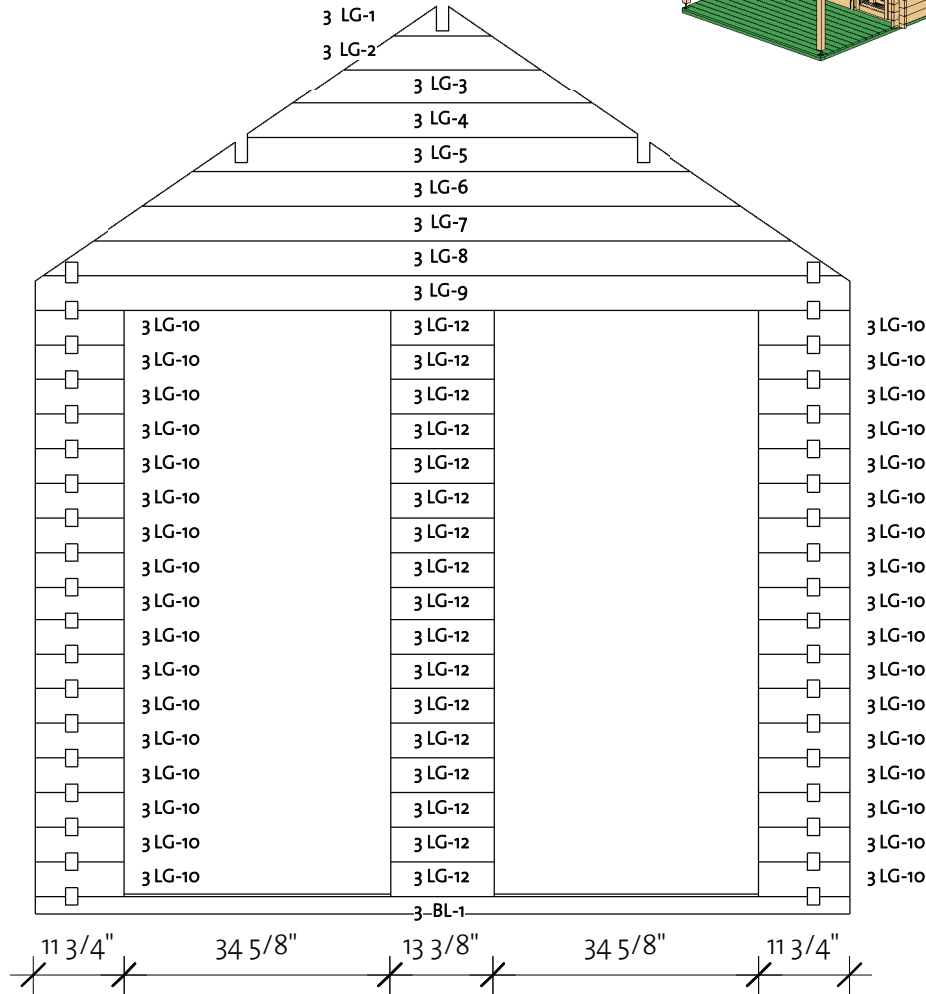
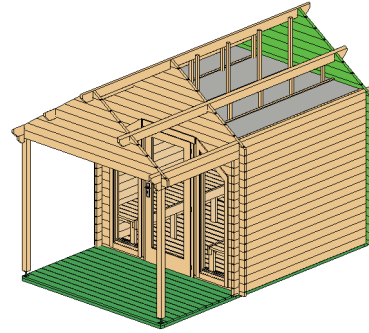



Wall 3			
Mark	Profile	Count	Cut Length

3BL-1	40X57	1	106 1/4"
3LG-1 *	40X114	1	12 5/8"
3LG-2 *	40X114	1	25 3/4"
3LG-3 *	40X114	1	38 7/8"
3LG-4 *	40X114	1	50 5/8"
3LG-5 *	40X114	1	65"
3LG-6 *	40X114	1	78"
3LG-7 *	40X114	1	91 1/8"
3LG-8 *	40X114	1	104 1/4"
3LG-9 *	40X114	1	106 1/4"
3LG-10	40X114	34	11 3/4"
3LG-12	40X114	17	13 3/8"

\* Gable - delivered premounted

Log Profile Wall 3	
Profile	Profile

40X57	
40X114	

# Sauna Dockside A 40 (98 3/8"x98 3/8")

Wall A

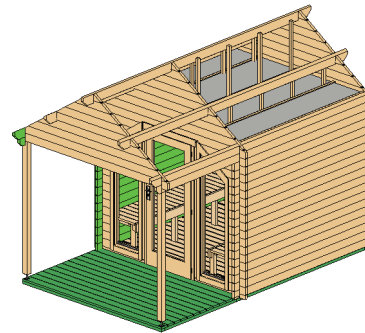

Wall A			
Mark	Profile	Count	Cut Length

ALG-1	40X114	1	165 3/8"
ALG-2	40X114	17	106 1/4"
ATL-1	40X135	1	173 1/4"

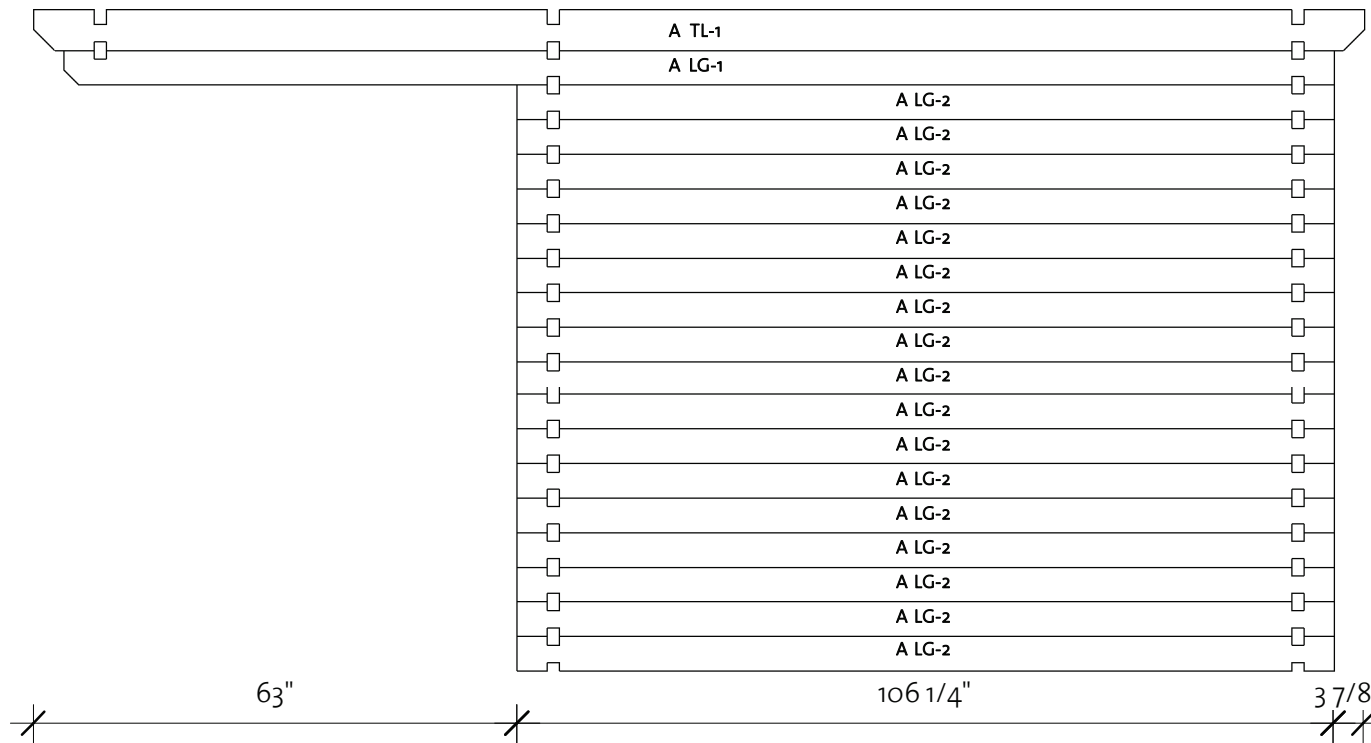

Log Profile Wall A	
Profile	Profile

40X114	
40X135	

# Sauna Dockside A 40 (98 3/8"x98 3/8")

Wall B

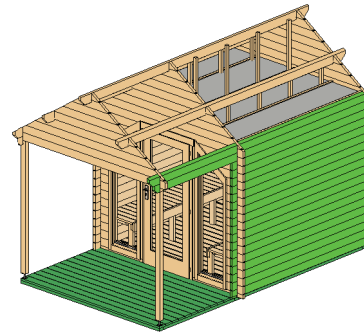

Wall B			
Mark	Profile	Count	Cut Length

BLG-1	40X114	1	165 3/8"
BLG-2	40X114	17	106 1/4"
BTL-1	40X135	1	173 1/4"

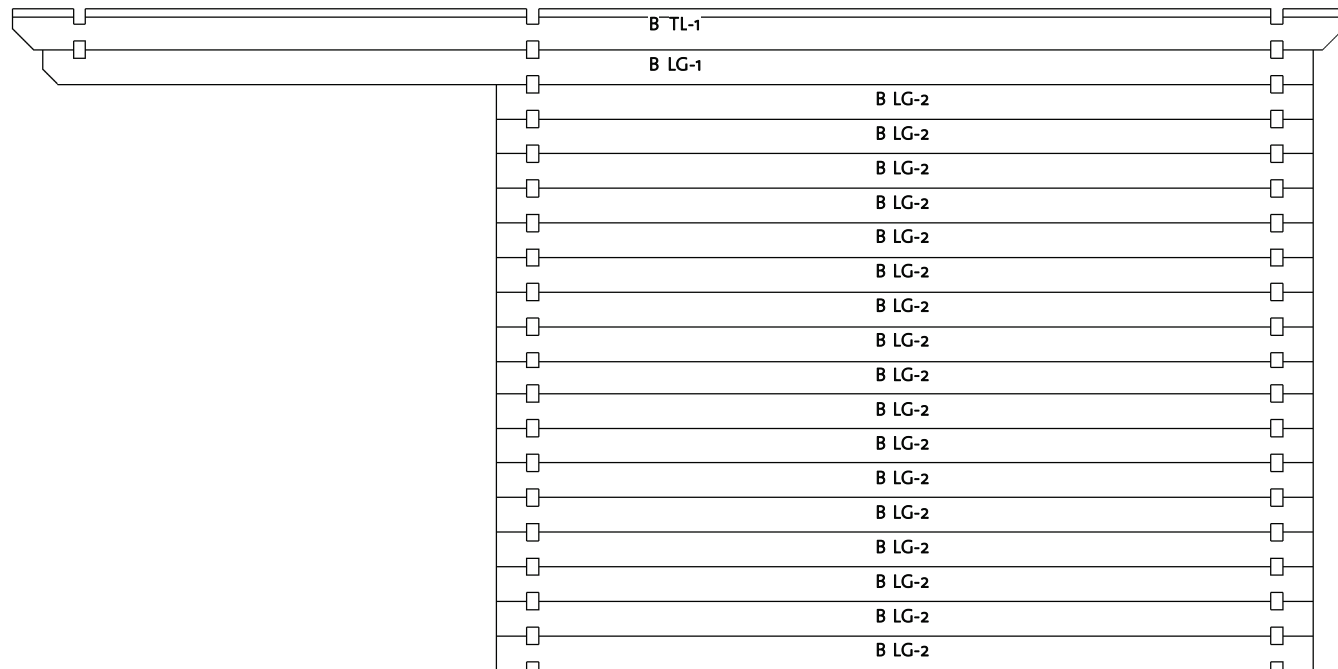





Log Profile Wall B	
Profile	Profile

40X135	
40X114	

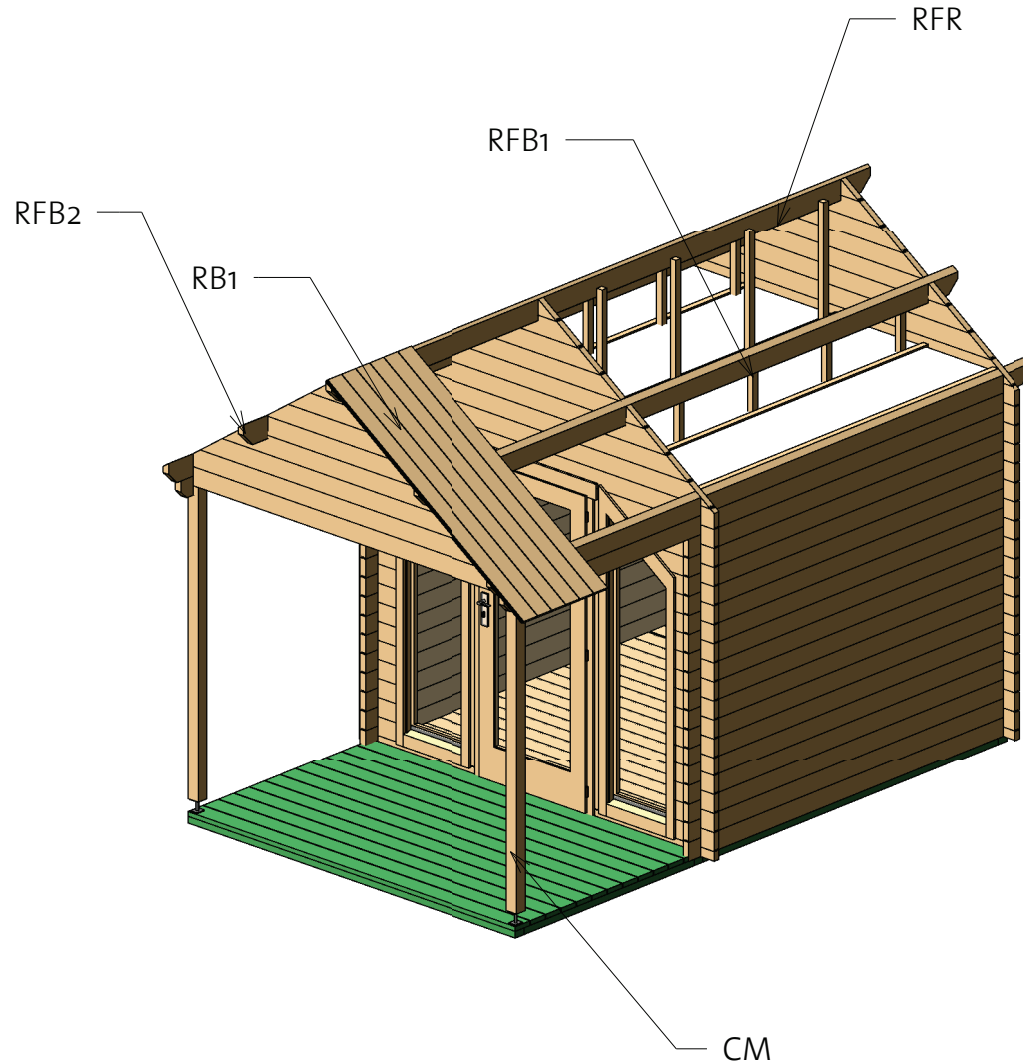
# Sauna Dockside A 40 (98 3/8"x98 3/8")

Roof 1



Roof				
Mark	Type	Profile	Count	Length
RB	17x114		78	71 5/8"
RFB1	Beam 40x143		1	173 1/4"
RFB2	Beam 40x143		1	173 1/4"
RFR	Ridge 40x143		1	173 1/4"

Columns			
Mark	Profile	Count	Length
CM	Post 80x70	2	74 1/2"

# Sauna Dockside A 40 (98 3/8"x98 3/8")

Roof 2

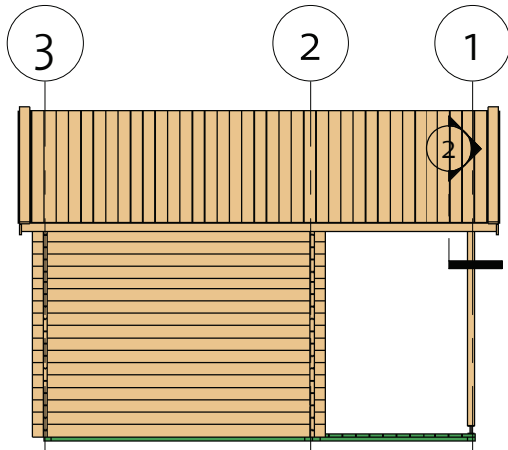

② Facia

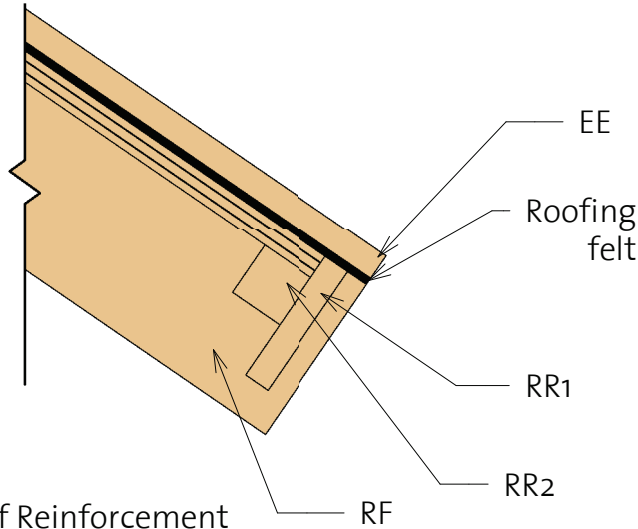

③ Roof Reinforcement

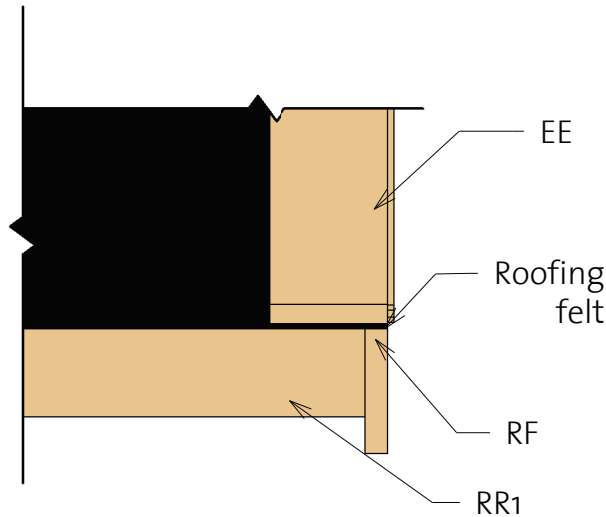
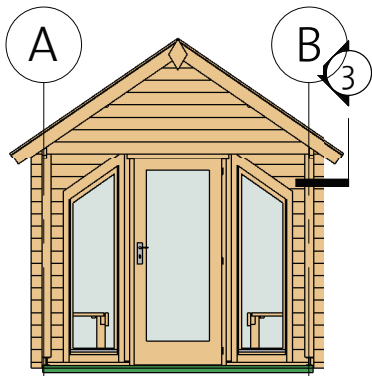

Fascia Schedule



Mark	Type	Profile	Count	Length
EE	Eave Edging 18x95		4	73 3/8"
RF	Roof Fascia 18x120		4	73 3/8"
RR1	Roof reinforce ment 18x95		2	173 1/4"
RR2	Roof reinforce ment 38x38		2	173 1/4"

# Sauna Dockside A 40 (98 3/8"x98 3/8")

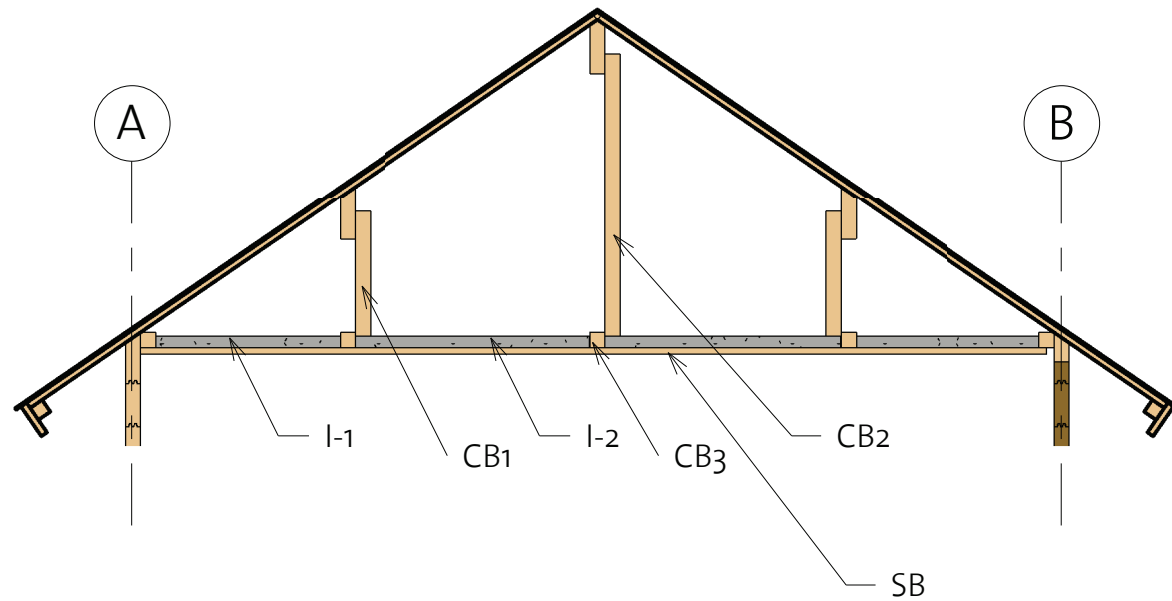
Ceiling



Ceiling Schedule

Mark	Type	Profile	Count	Length
CB1	40x40		8	14 1/8"
CB2	40x40		4	30 3/4"
CB3	40x40		5	95 1/8"
SB	15x80		31	94 1/2"

Insulation Schedule

Mark	Type	Count	Length
I-1	Insulation 486	2	94 1/2"
I-2	Insulation 622	2	94 1/2"

# Sauna Dockside A 40 (98 3/8"x98 3/8")

Extras

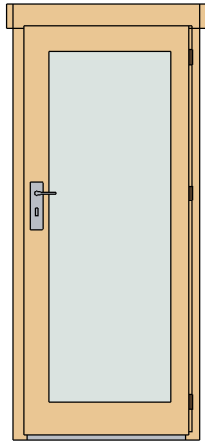

Door Schedule				
Model	Type	Width	Height	Count
CD6R	Classic door 6 right, Tempered	33 1/8"	77"	1

Type	Count
------	-------

Romb	2
------	---



Fasteners/Extras			Window Schedule				
Name	Type	Count	Mark	Type	Width	Height	Count

Hitblock	300-400 mm		CW4R	Classic window 4, right Tempered	34 1/2"	74 3/8"	2
Adjustable post foot		2	CW25	Classic window 25, Tempered	20 1/4"	74 3/8"	1
Nails	1,4 x 40	25	CW26	Classic window 26, Tempered	20 1/4"	74 3/8"	1
Screws	6,0 x 140	40					
Screws	5,0 x 70	50					
Screws	4,8 x 75	120					
Screws	4,0 x 40	580					

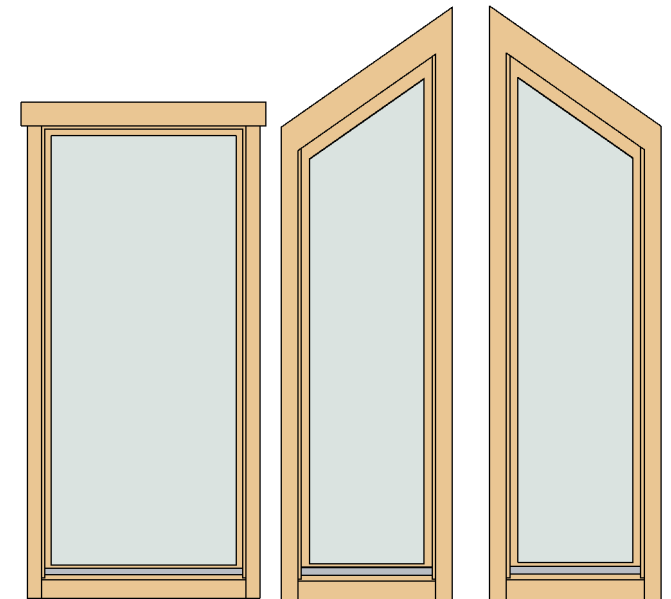

- \* Windows intended for tilt opening only!
- \* Fenster zur Eröffnung nur zum Kippen vorgesehen!
- \* Aknad on ette nähtud ainult kaldu avamiseks!





# Sauna Dockside A 40 (98 3/8"x98 3/8")

## List of all items 1

### Impregnated foundation beams

Mark	Type	Profile	Count	Length
IFB1	IFB 70x40		5	91 7/8"
IFB2	IFB 70x40		4	98"
IFB3	IFB 70x40		5	54 1/2"



### Roof

Mark	Type	Profile	Count	Length
RB	17x114		78	71 5/8"
RFB1	Beam 40x143		1	173 1/4"
RFB2	Beam 40x143		1	173 1/4"
RFR	Ridge 40x143		1	173 1/4"





### Floor Schedule

Mark	Type	Profile	Count	Length
FB	FB 17x114		22	95"

### Terrace Schedule

TB	TB 28x120		12	98"
BB	BB 18x40		4	98 3/8"

### Fascia Schedule

Mark	Type	Profile	Count	Length
EE	Eave Edging 18x95		4	73 3/8"
RF	Roof Fascia 18x120		4	73 3/8"
RR1	Roof reinforce ment 18x95		2	173 1/4"
RR2	Roof reinforce ment 38x38		2	173 1/4"

# Sauna Dockside A 40 (98 3/8"x98 3/8")

## List of all items 2

Wall 1			
Mark	Profile	Count	Cut Length

1LG-1 *	40X114	1	12 5/8"
1LG-2 *	40X114	1	25 3/4"
1LG-3 *	40X114	1	38 7/8"
1LG-4 *	40X114	1	50 5/8"
1LG-5 *	40X114	1	65"
1LG-6 *	40X114	1	78"
1LG-7 *	40X114	1	91 1/8"
1LG-8 *	40X114	1	104 1/4"
1LG-9 *	40X114	1	106 1/4"

Wall 2			
Mark	Profile	Count	Cut Length

2BL-1	40X57	2	36 3/8"
2LG-1 *	40X114	1	12 5/8"
2LG-2 *	40X114	1	25 3/4"
2LG-3 *	40X114	1	38 7/8"
2LG-4 *	40X114	1	50 5/8"
2LG-5 *	40X114	1	65"
2LG-6 *	40X114	1	78"
2LG-7 *	40X114	1	91 1/8"
2LG-8 *	40X114	1	104 1/4"
2LG-9 *	40X114	1	106 1/4"
2LG-10	40X114	26	12 1/2"
2LG-11	40X114	2	32 7/8"
2LG-12	40X114	2	27 1/4"
2LG-13	40X114	2	20 3/4"
2LG-14	40X114	2	14 3/8"

Wall 3			
Mark	Profile	Count	Cut Length

3BL-1 *	40X57	1	106 1/4"
3LG-1 *	40X114	1	12 5/8"
3LG-2 *	40X114	1	25 3/4"
3LG-3 *	40X114	1	38 7/8"
3LG-4 *	40X114	1	50 5/8"
3LG-5 *	40X114	1	65"
3LG-6 *	40X114	1	78"
3LG-7 *	40X114	1	91 1/8"
3LG-8 *	40X114	1	104 1/4"
3LG-9 *	40X114	1	106 1/4"
3LG-10	40X114	34	11 3/4"
3LG-12	40X114	17	13 3/8"

\* Gable - delivered premounted

Wall B			
Mark	Profile	Count	Cut Length

BLG-1	40X114	1	165 3/8"
BLG-2	40X114	17	106 1/4"
BTL-1	40X135	1	173 1/4"





Wall A			
Mark	Profile	Count	Cut Length

ALG-1	40X114	1	165 3/8"
ALG-2	40X114	17	106 1/4"
ATL-1	40X135	1	173 1/4"

# Sauna Dockside A 40 (98 3/8"x98 3/8")

## List of all items 3

Log profiles	
Profile	Profile

40x57	
40x135	
40x135	
40x114	

Columns			
Mark	Profile	Count	Length

CM	Post 80x70	2	74 1/2"
----	------------	---	---------

Column schedule		
Type	Length	Count

Post 40x90	76"	2
------------	-----	---