

Sauna Flat B 40 (98 3/8" x 177 1/8")

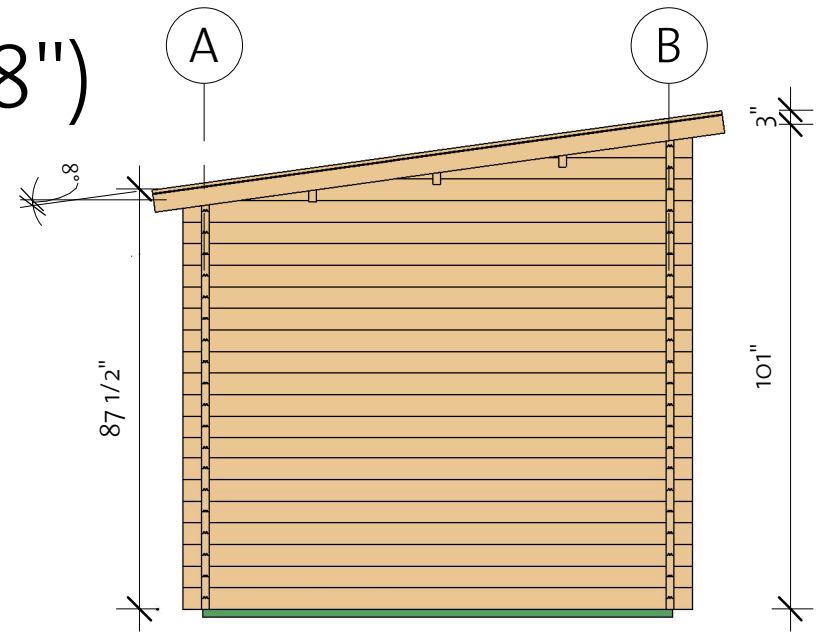

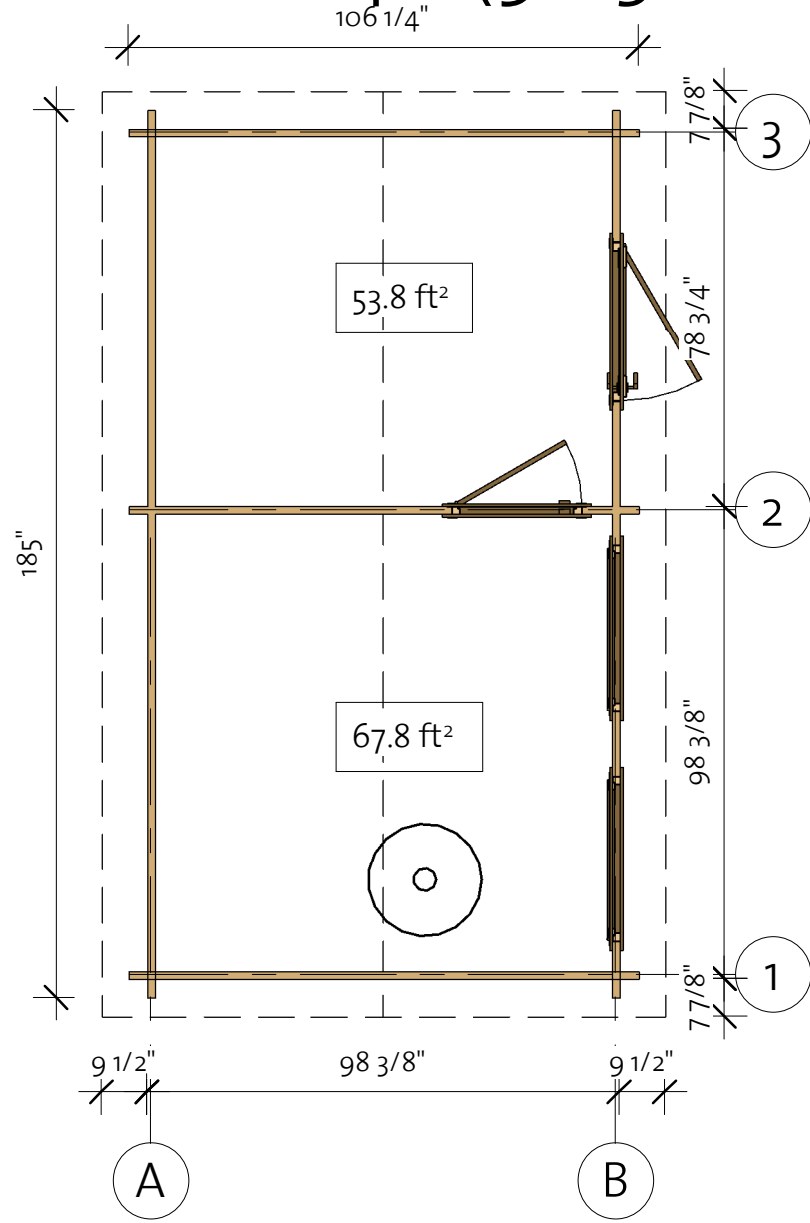

EZ Log Structures
 Do-It-Yourself Building Kits

Sauna Flat B 40 (98 3/8" x 177 1/8")

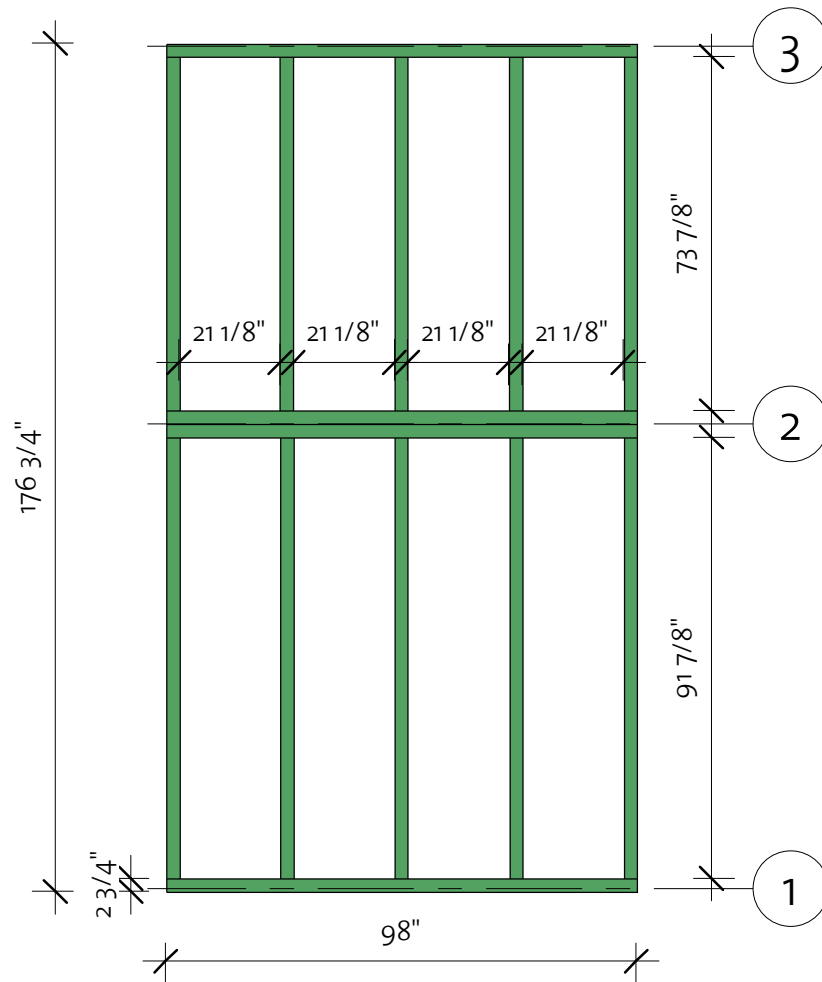
Foundation



Impregnated foundation beams				
Mark	Type	Profile	Count	Length

IFB1	IFB 70x40		4	98"
IFB2	IFB 70x40		5	91 7/8"
IFB3	IFB 70x40		5	73 7/8"

Sauna Flat B 40 (98 3/8" x 177 1/8")

Floor Plan

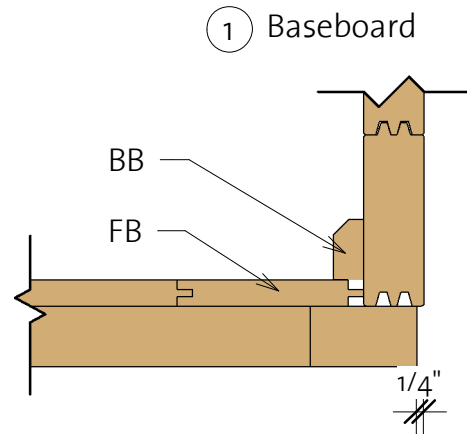

Floor Schedule				
Mark	Type	Profile	Count	Length

FB	FB 17x114		39	95"
----	-----------	---	----	-----

BB1	BB 18x40		6	98 3/8"
BB2	BB 18x40		2	78 3/4"

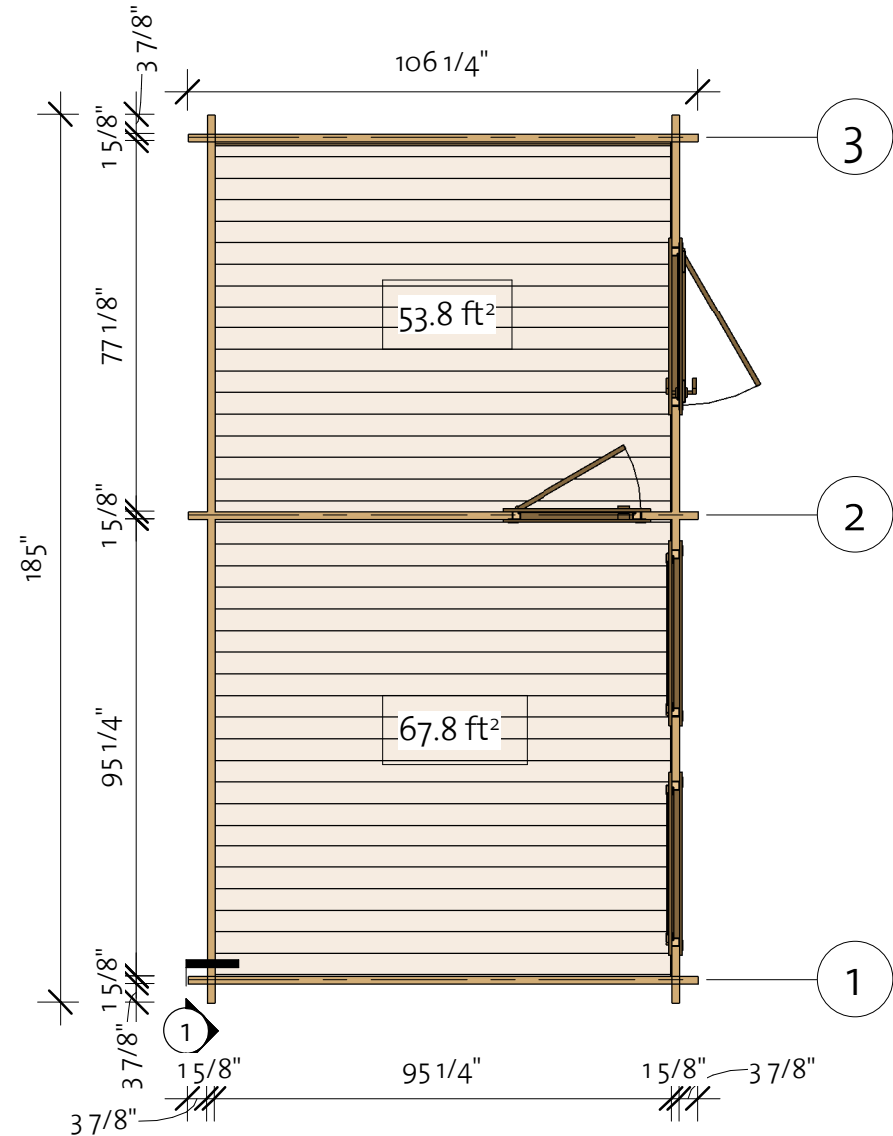

Sauna Flat B 40 (98 3/8" x 177 1/8")

Wall 1

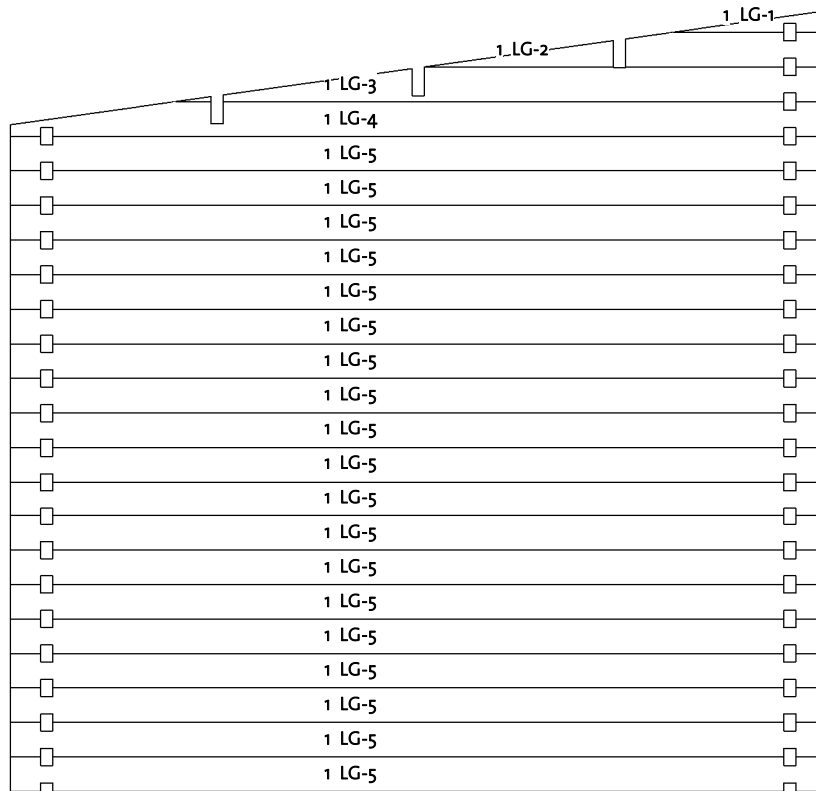
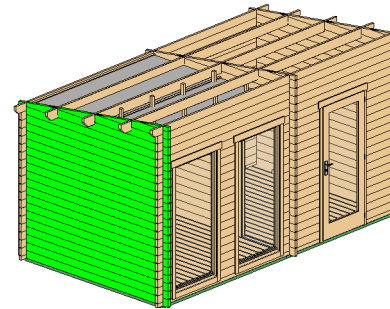

Wall 1			
Mark	Profile	Count	Cut Length

1LG-1 *	40X114	1	20 1/8"
1LG-2 *	40X114	1	52 3/8"
1LG-3 *	40X114	1	84 5/8"
1LG-4 *	40X114	1	106 1/4"
1LG-5	40X114	19	106 1/4"

* Gable - delivered premounted

Log Profile Wall 1	
Profile	Profile

40X114	
--------	---

Sauna Flat B 40 (98 3/8" x 177 1/8")

Wall 3

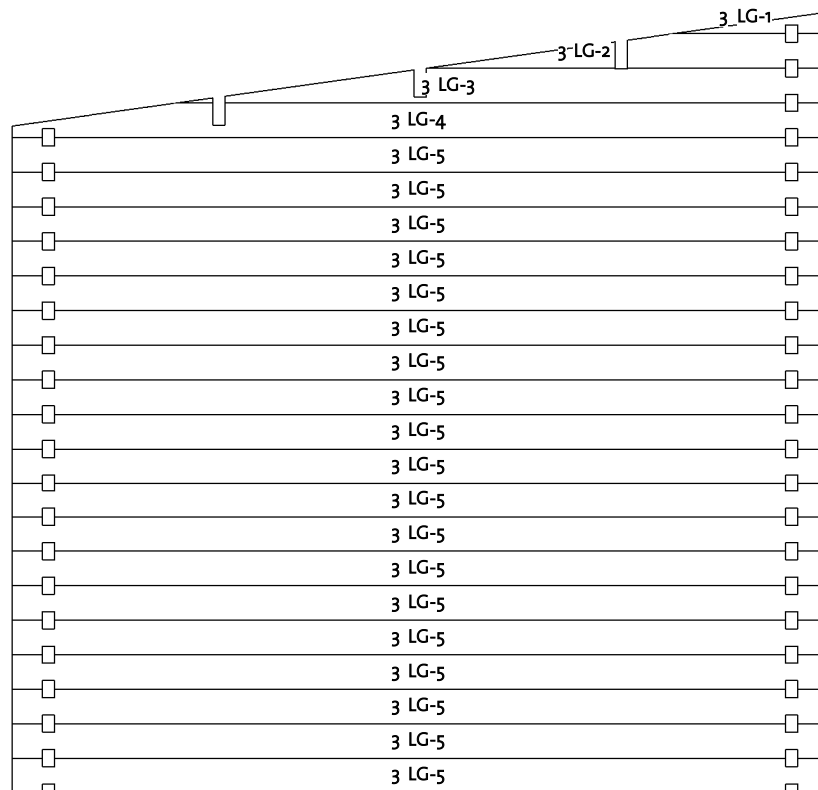
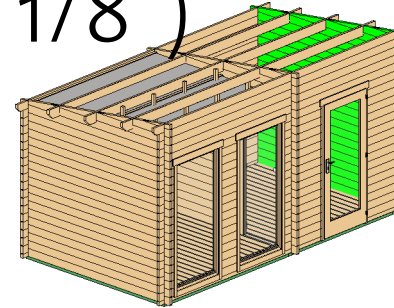

Wall 3			
Mark	Profile	Count	Cut Length

3LG-1 *	40X114	1	20 1/8"
3LG-2 *	40X114	1	52 3/8"
3LG-3 *	40X114	1	84 5/8"
3LG-4 *	40X114	1	106 1/4"
3LG-5	40X114	19	106 1/4"

* Gable - delivered premounted

Log Profile Wall 3	
Profile	Profile

40X114	
--------	--

Sauna Flat B 40 (98 3/8" x 177 1/8")

Wall B

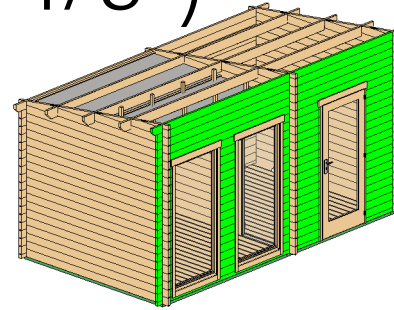

Wall B			
Mark	Profile	Count	Cut Length

BBL-1	40X57	1	124 1/4"
BBL-2	40X57	1	27 3/8"
BLG-1	40X114	17	11 3/4"
BLG-2	40X114	17	13 3/8"
BLG-3	40X114	17	29 3/4"
BLG-4	40X114	17	27 3/8"
BLG-5	40X114	4	185"
BTL-1	40X114	1	192 7/8"

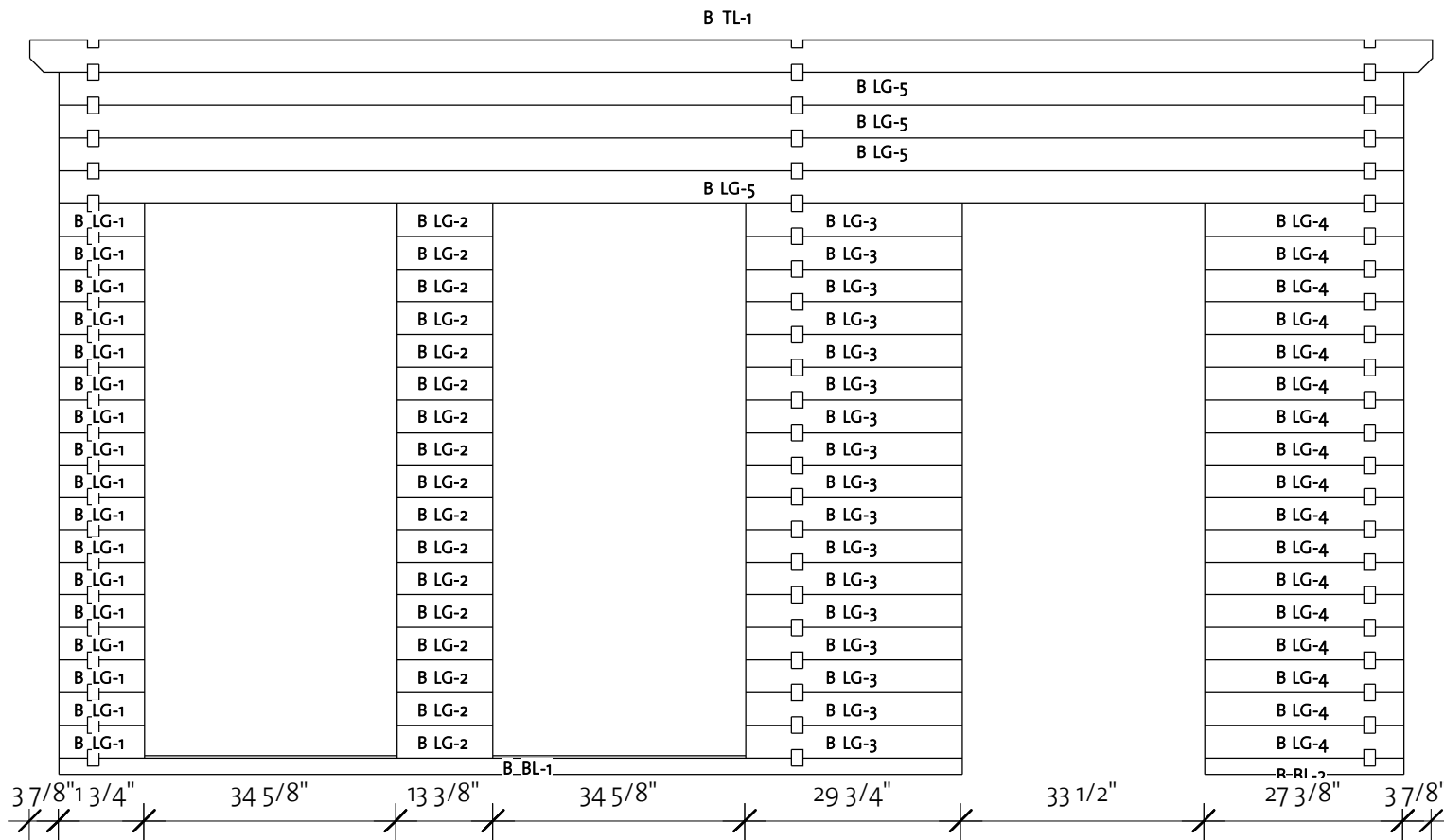

Log Profile Wall B	
Profile	Profile



40X114	
40X114	
40X57	

92503055_250916

Sauna Flat B 40 (98 3/8" x 177 1/8")

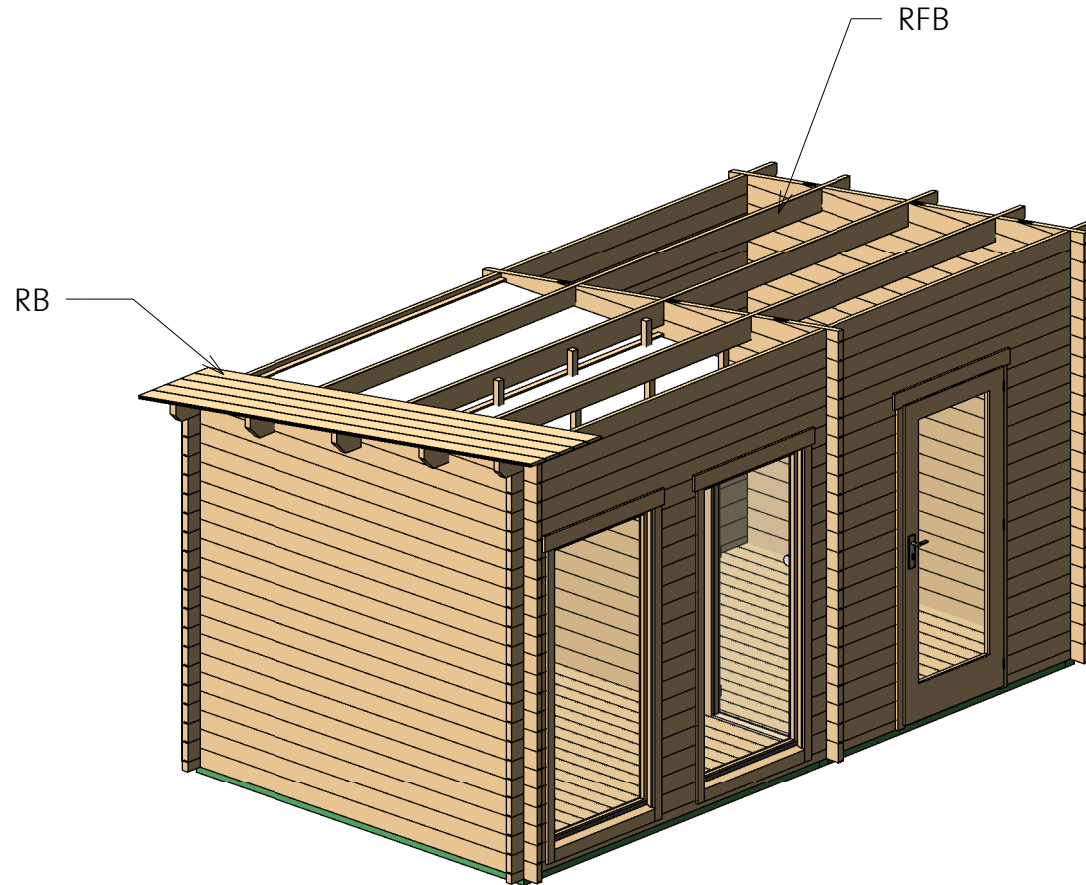
Roof 1



Roof				
Mark	Type	Profile	Count	Length
RB	17x114		44	118 3/8"
RFB	Beam 40x143		3	192 7/8"

Sauna Flat B 40 (98 3/8" x 177 1/8")

Roof 2

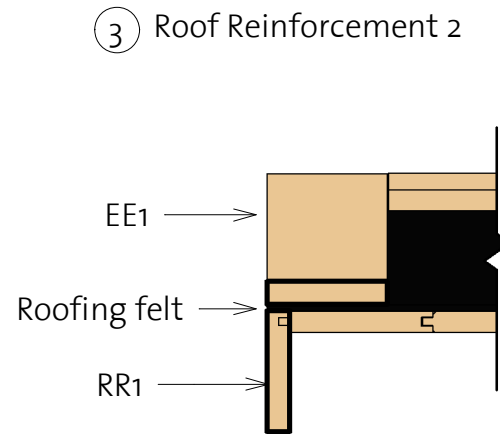
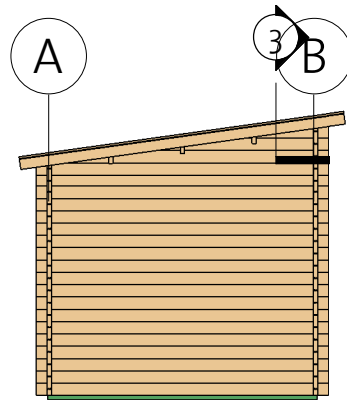
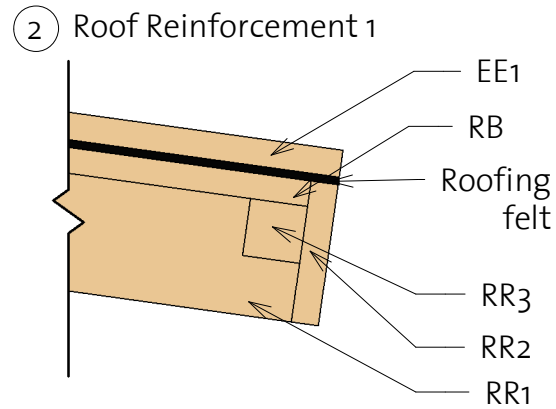
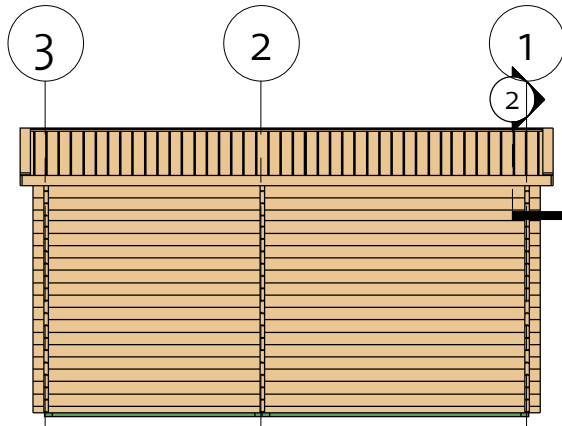



Fascia Schedule				
Mark	Type	Profile	Count	Length
EE1	Eave Edging 18x95		2	119 3/4"
EE2	Eave Edging 18x95		1	186 3/4"
RR1	Roof reinforcement 18x95		2	119 3/4"
RR2	Roof reinforcement 18x95		2	192 7/8"
RR3	Roof reinforcement 38x38		2	192 7/8"

Sauna Flat B 40 (98 3/8" x 177 1/8")

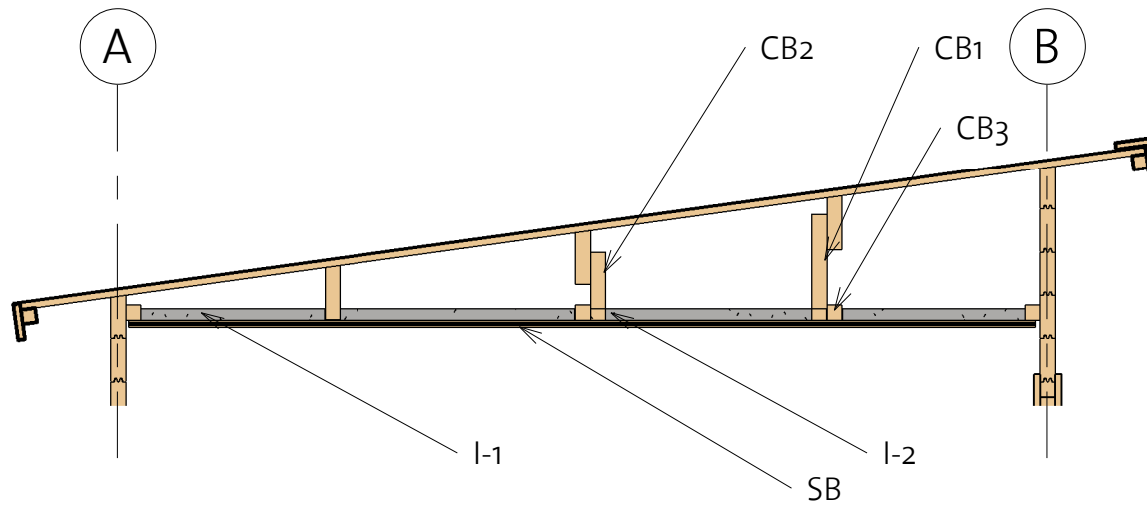
Ceiling



Ceiling Schedule				
Mark	Type	Profile	Count	Length
CB1	40x40		4	11"
CB2	40x40		4	7 1/8"
CB3	40x40		4	95 1/8"
SB	15x80		31	94 1/2"

Insulation Schedule			
Mark	Type	Count	Length
I-1	Insulation 486	2	94 1/2"
I-2	Insulation 622	2	94 1/2"

Sauna Flat B 40 (98 3/8" x 177 1/8")

Extras

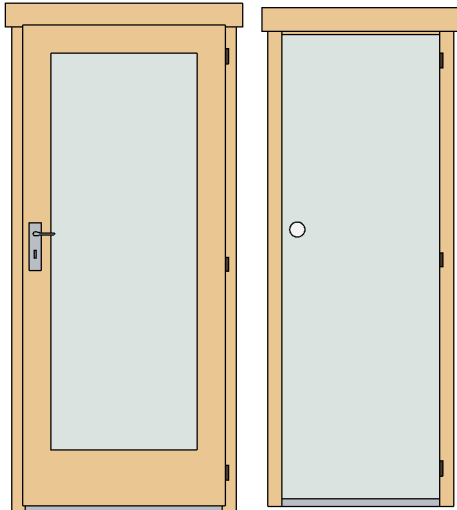

Door Schedule				
Model	Type	Width	Height	Count
SD	Sauna door	27"	75 5/8"	1
CD6R	Classic door 6 right	33 1/8"	77"	1

Fasteners/Extras		
Name	Type	Count

Hitblock	300-400 mm	
Screws	5,0 x 70	30
Nails	1,4 x 40	45
Screws	6,0 x 140	60
Screws	4,0 x 40	520

Window Schedule				
Mark	Type	Width	Height	Count
CW4R	Classic window 4, right tempered	34 1/2"	74 3/8"	2

- * Windows intended for tilt opening only!
- * Fenster zur Eröffnung nur zum Kippen vorgesehen!
- * Aknad on ette nähtud ainult kaldu avamiseks!

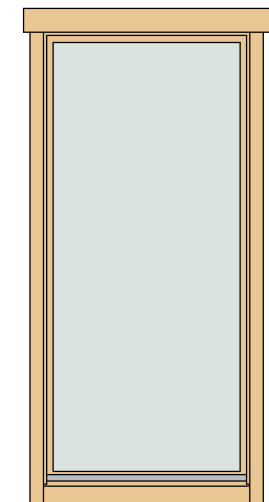

Sauna Flat B 40 (98 3/8"x177 1/8")

List of all items 1

Impregnated foundation beams



Mark	Type	Profile	Count	Length
IFB1	IFB 70x40		4	98"
IFB2	IFB 70x40		5	91 7/8"
IFB3	IFB 70x40		5	73 7/8"

Floor Schedule





Mark	Type	Profile	Count	Length
FB	FB 17x114		39	95"

BB1	BB 18x40		6	98 3/8"
BB2	BB 18x40		2	78 3/4"

Roof

Mark	Type	Profile	Count	Length
RB	17x114		44	118 3/8"
RFB	Beam 40x143		3	192 7/8"

Fascia Schedule

Mark	Type	Profile	Count	Length
EE1	Eave Edging 18x95		2	119 3/4"
EE2	Eave Edging 18x95		1	186 3/4"
RR1	Roof reinforce ment 18x95		2	119 3/4"
RR2	Roof reinforce ment 18x95		2	192 7/8"
RR3	Roof reinforce ment 38x38		2	192 7/8"

Sauna Flat B 40 (98 3/8"x177 1/8")

List of all items 2

Wall 1			
Mark	Profile	Count	Cut Length

1LG-1 *	40X114	1	20 1/8"
1LG-2 *	40X114	1	52 3/8"
1LG-3 *	40X114	1	84 5/8"
1LG-4 *	40X114	1	106 1/4"
1LG-5	40X114	19	106 1/4"

Wall 2			
Mark	Profile	Count	Cut Length

2LG-1 *	40X114	1	20 1/8"
2LG-2 *	40X114	1	52 3/8"
2LG-3 *	40X114	1	84 5/8"
2LG-4 *	40X114	1	106 1/4"
2LG-5	40X114	2	106 1/4"
2LG-6	40X114	17	67 3/8"
2LG-7	40X114	17	11 3/4"

Wall 3			
Mark	Profile	Count	Cut Length

3LG-1 *	40X114	1	20 1/8"
3LG-2 *	40X114	1	52 3/8"
3LG-3 *	40X114	1	84 5/8"
3LG-4 *	40X114	1	106 1/4"
3LG-5	40X114	19	106 1/4"

* Gable - delivered premounted

Wall A			
Mark	Profile	Count	Cut Length

ABL-1	40X57	1	185"
ALG-1	40X114	18	185"
ATL-1	40X114	1	192 7/8"

Wall B			
Mark	Profile	Count	Cut Length

BBL-1	40X57	1	124 1/4"
BBL-2	40X57	1	27 3/8"
BLG-1	40X114	17	11 3/4"
BLG-2	40X114	17	13 3/8"
BLG-3	40X114	17	29 3/4"
BLG-4	40X114	17	27 3/8"
BLG-5	40X114	4	185"
BTL-1	40X114	1	192 7/8"

Sauna Flat B 40 (98 3/8"x177 1/8")



List of all items 3



Insulation Schedule			
Mark	Type	Count	Length

I-1	Insulation 486	2	94 1/2"
I-2	Insulation 622	2	94 1/2"

Log profiles	
Profile	Profile

Ceiling Schedule				
Mark	Type	Profile	Count	Length

CB1	40x40		4	11"
CB2	40x40		4	7 1/8"
CB3	40x40		4	95 1/8"
SB	15x80		31	94 1/2"

40x57	
40x114	
40x114	