

# Sauna Flat B 40 (250x450)

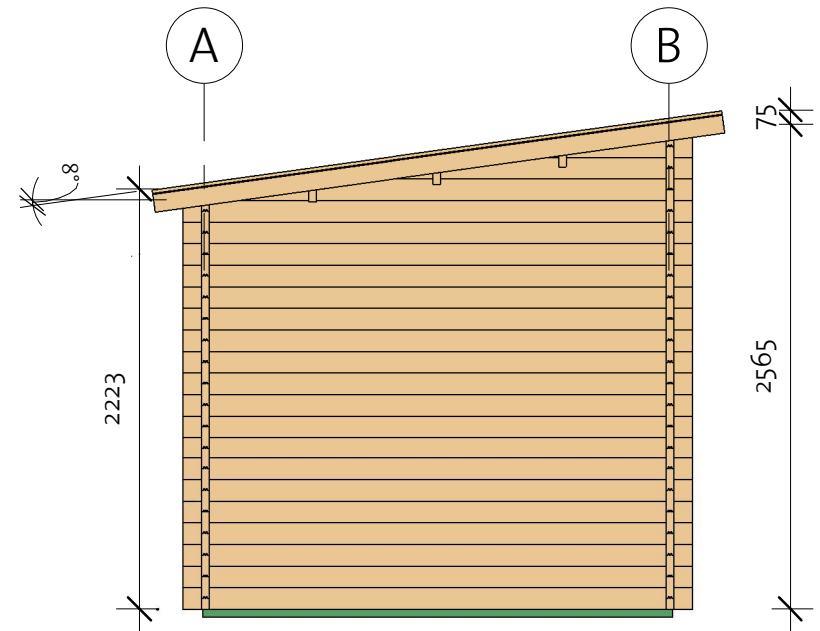

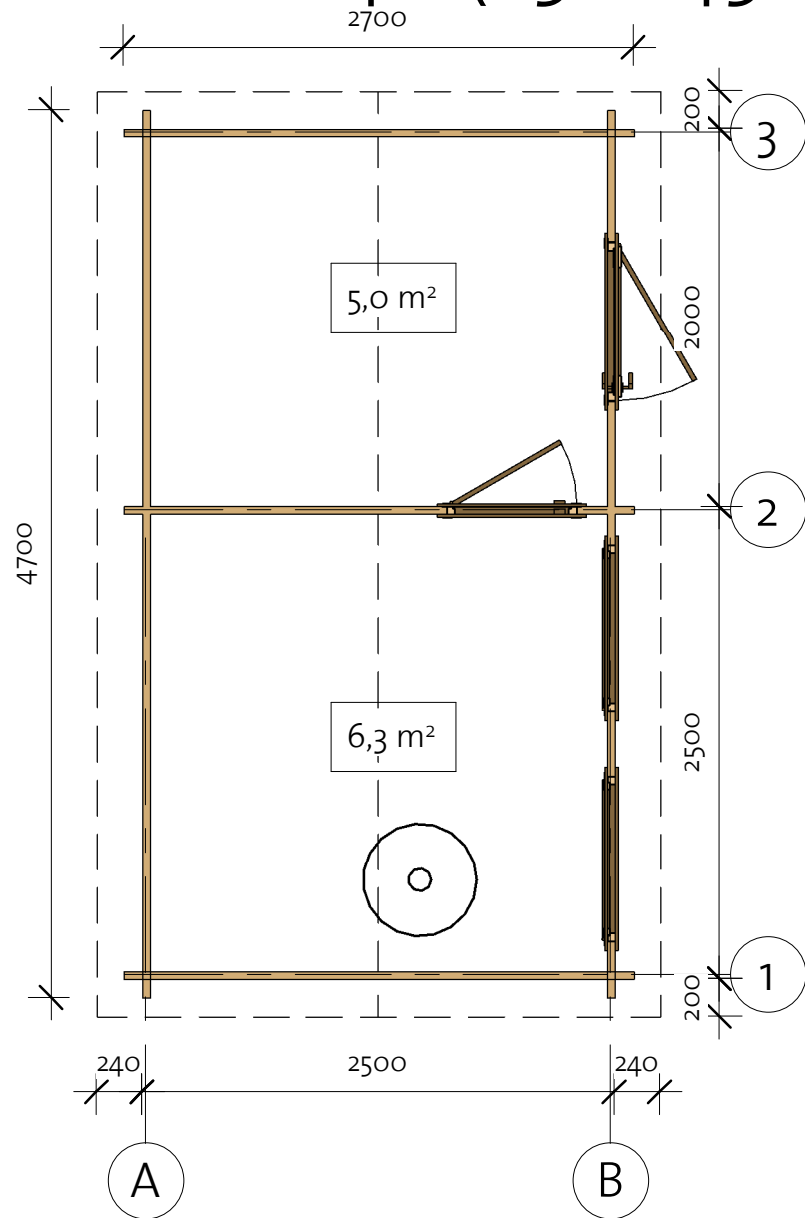

92503055\_250916

**EZ** Log Structures  
Do-It-Yourself Building Kits

# Sauna Flat B 40 (250x450)

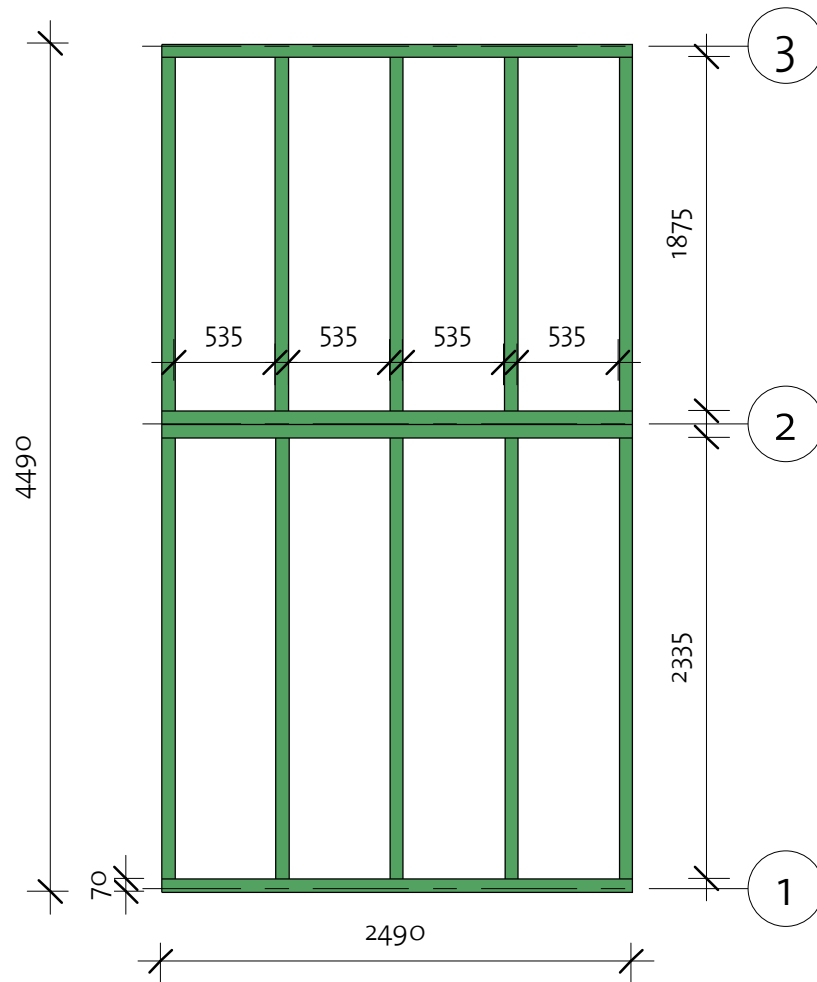
Foundation



Impregnated foundation beams				
Mark	Type	Profile	Count	Length
IFB1	IFB 70x40		4	2490
IFB2	IFB 70x40		5	2335
IFB3	IFB 70x40		5	1875

# Sauna Flat B 40 (250x450)

Floor Plan

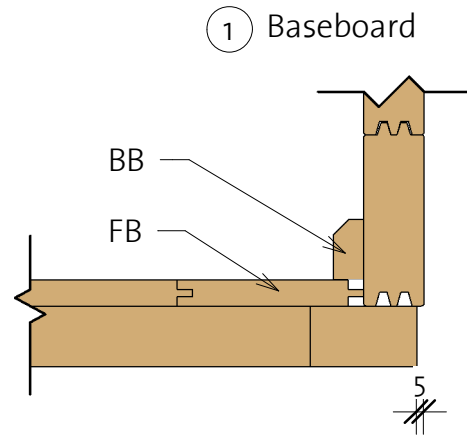

Floor Schedule				
Mark	Type	Profile	Count	Length

FB	FB 17x114		39	2414
----	-----------	--	----	------

BB1	BB 18x40		6	2500
BB2	BB 18x40		2	2000

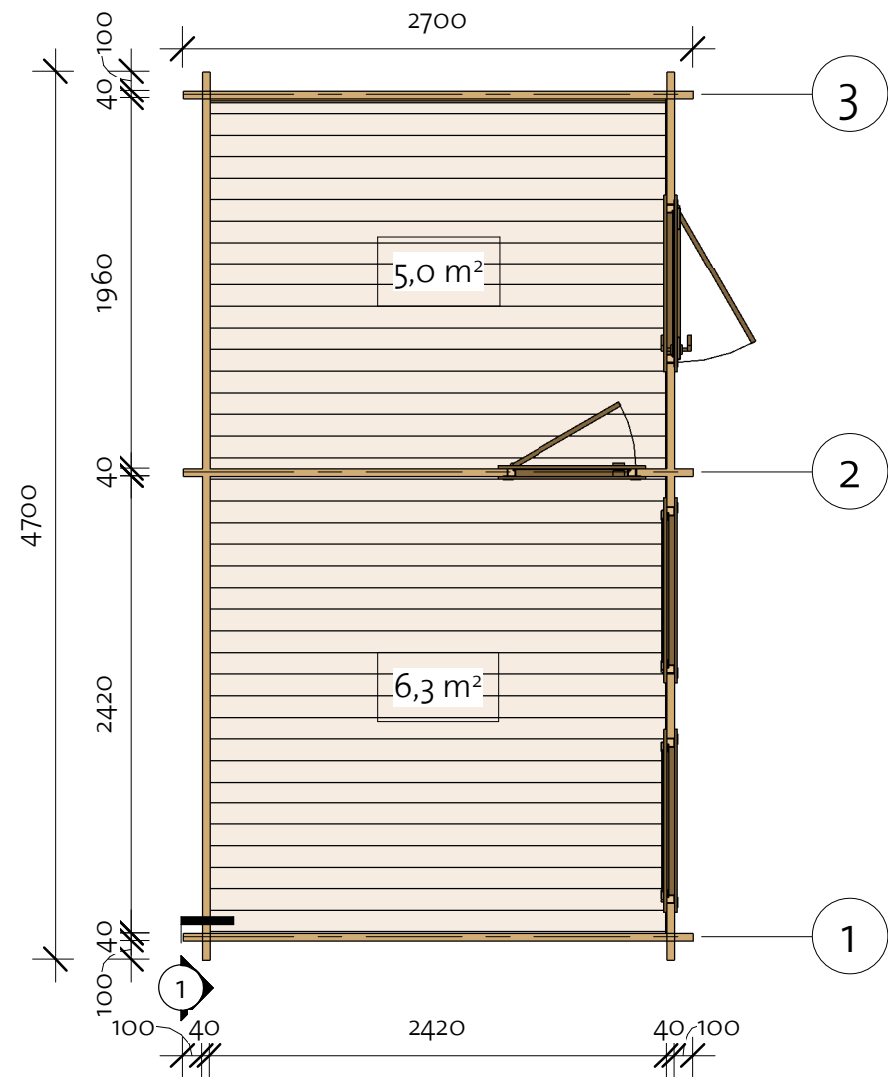

# Sauna Flat B 40 (250x450)

Wall 1

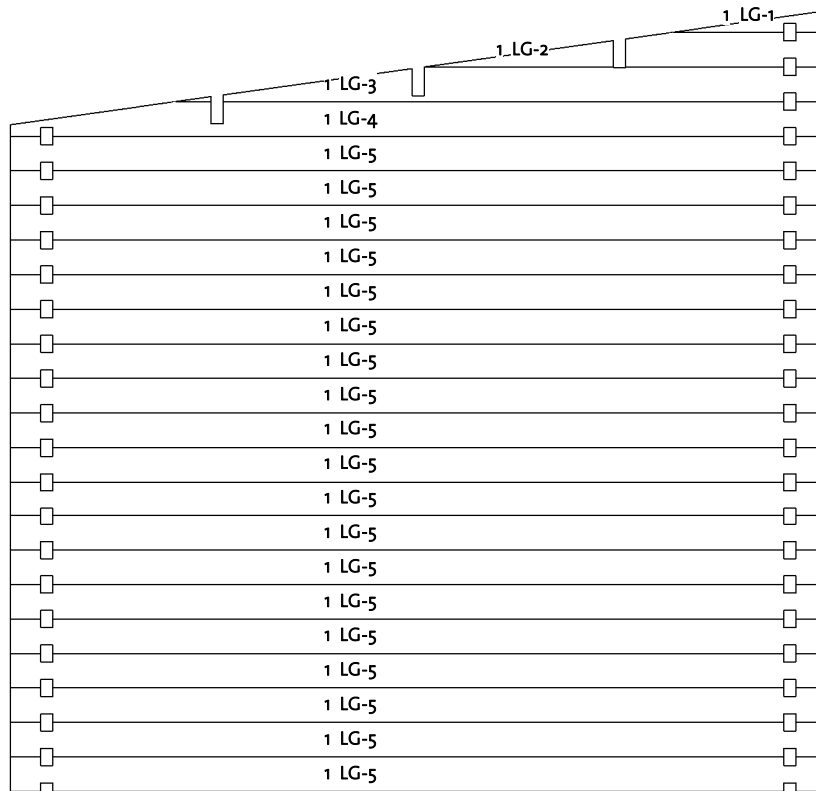
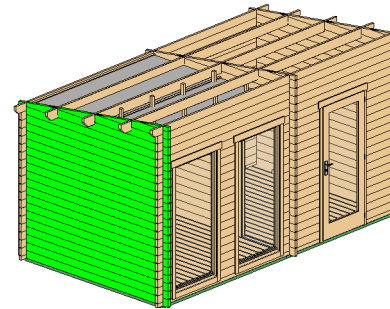

Wall 1			
Mark	Profile	Count	Cut Length

1LG-1 *	40X114	1	510
1LG-2 *	40X114	1	1330
1LG-3 *	40X114	1	2150
1LG-4 *	40X114	1	2700
1LG-5	40X114	19	2700

\* Gable - delivered premounted

Log Profile Wall 1	
Profile	Profile

40X114	
--------	---

# Sauna Flat B 40 (250x450)

Wall 2

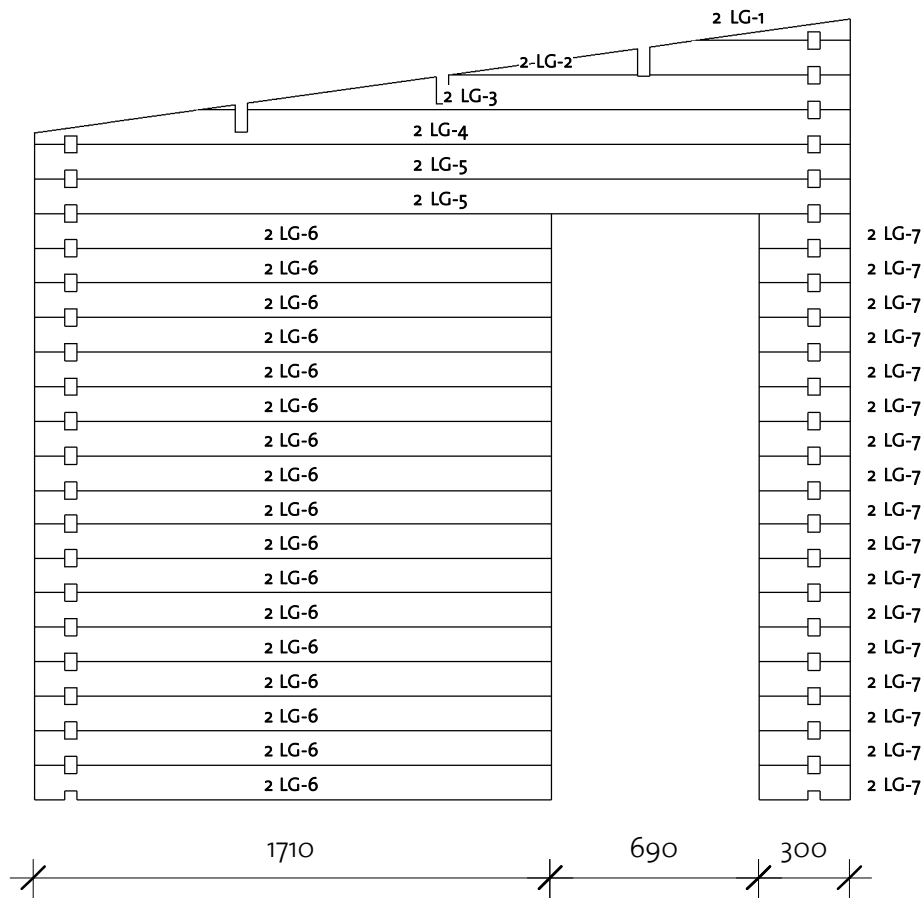
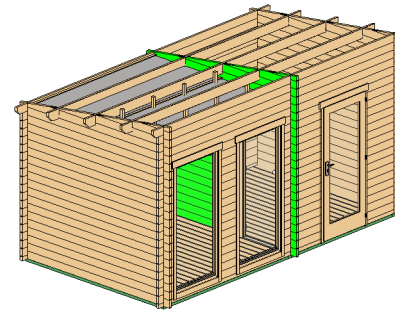

Wall 2			
Mark	Profile	Count	Cut Length

2LG-1 *	40X114	1	510
2LG-2 *	40X114	1	1330
2LG-3 *	40X114	1	2150
2LG-4 *	40X114	1	2700
2LG-5	40X114	2	2700
2LG-6	40X114	17	1710
2LG-7	40X114	17	300

\* Gable - delivered premounted

Log Profile Wall 2	
Profile	Profile

40X114	
--------	--

# Sauna Flat B 40 (250x450)

Wall 3

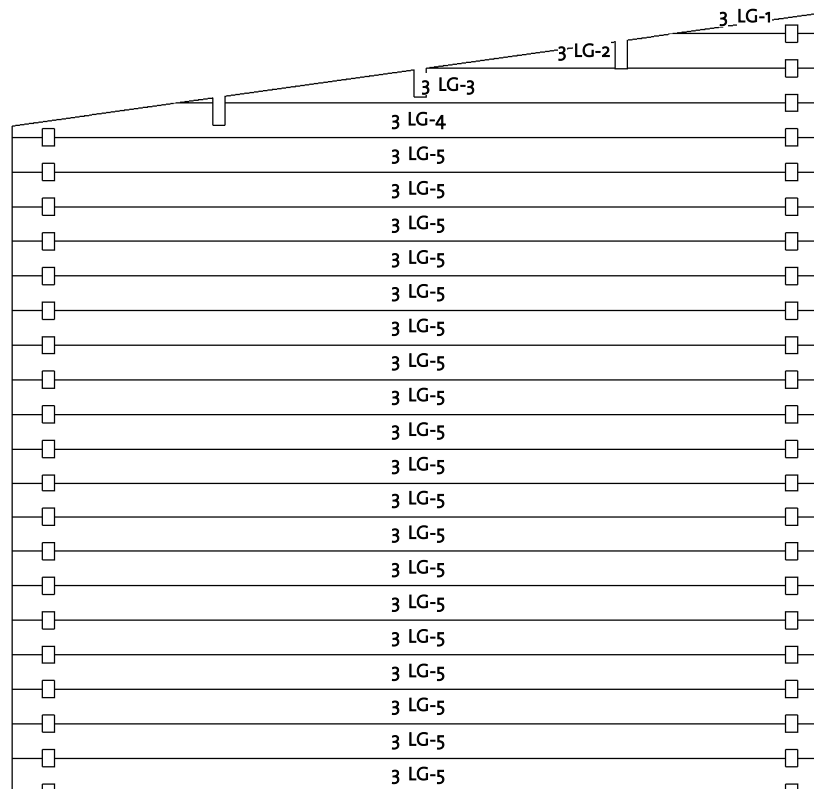
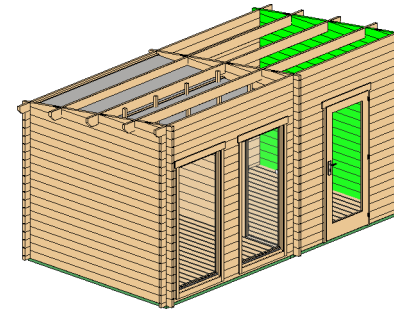

Wall 3			
Mark	Profile	Count	Cut Length

3LG-1 *	40X114	1	510
3LG-2*	40X114	1	1330
3LG-3*	40X114	1	2150
3LG-4*	40X114	1	2700
3LG-5	40X114	19	2700

\* Gable - delivered premounted

Log Profile Wall 3	
Profile	Profile

40X114	
--------	--

# Sauna Flat B 40 (250x450)

Wall A

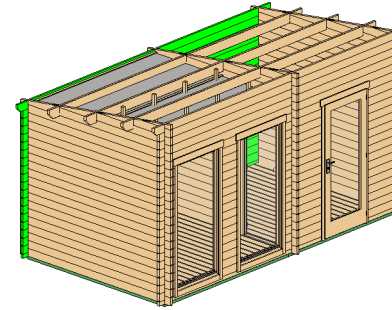

Wall A			
Mark	Profile	Count	Cut Length

ABL-1	40x57	1	4700
ALG-1	40x114	18	4700
ATL-1	40x114	1	4900

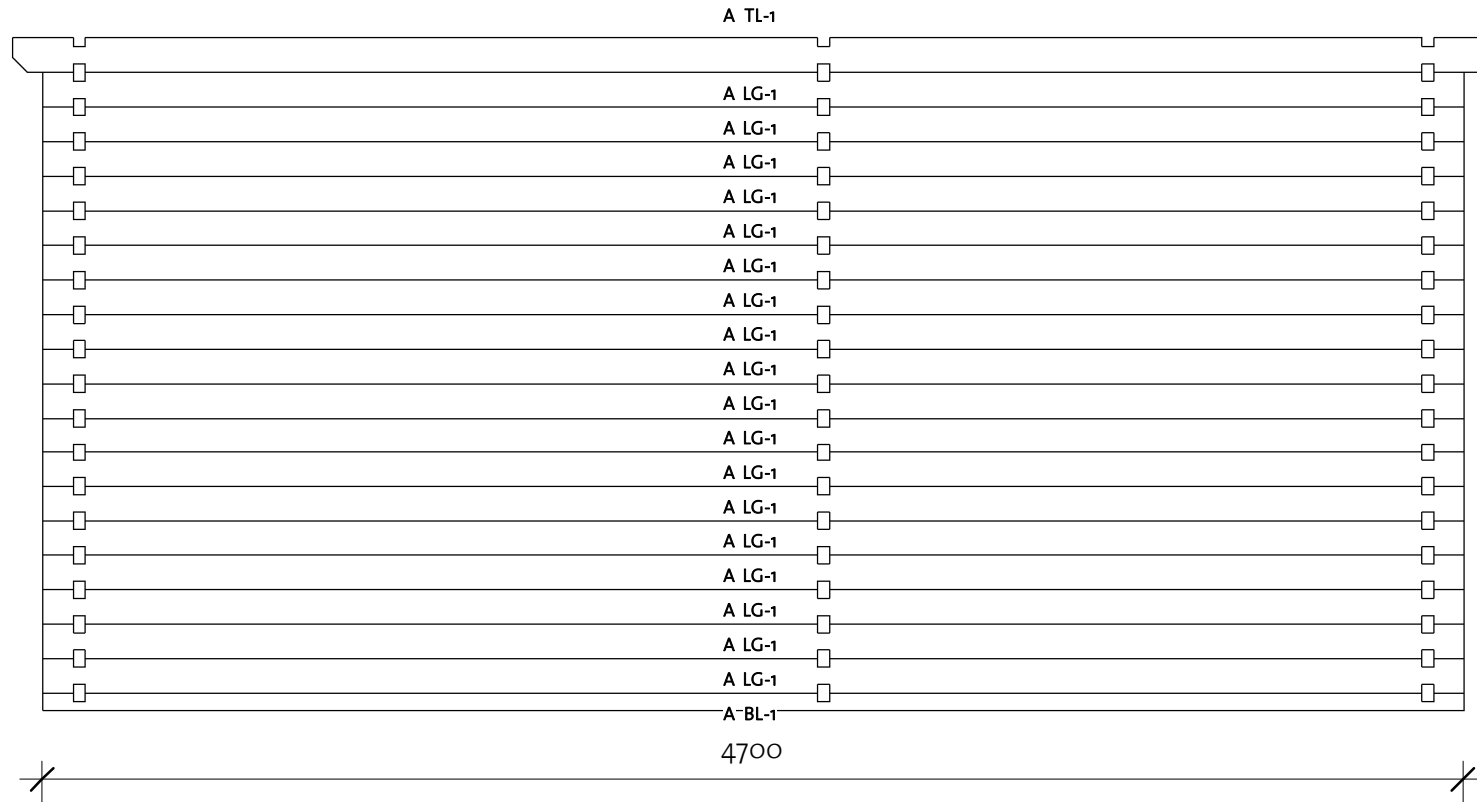

Log Profile Wall A	
Profile	Profile

40x57	
40x114	
40x114	

# Sauna Flat B 40 (250x450)

Wall B

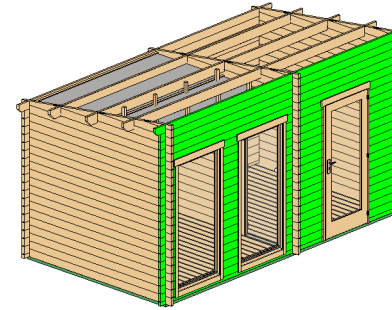

Wall B			
Mark	Profile	Count	Cut Length

BBL-1	40X57	1	3155
BBL-2	40X57	1	695
BLG-1	40X114	17	300
BLG-2	40X114	17	340
BLG-3	40X114	17	755
BLG-4	40X114	17	695
BLG-5	40X114	4	4700
BTL-1	40X114	1	4900

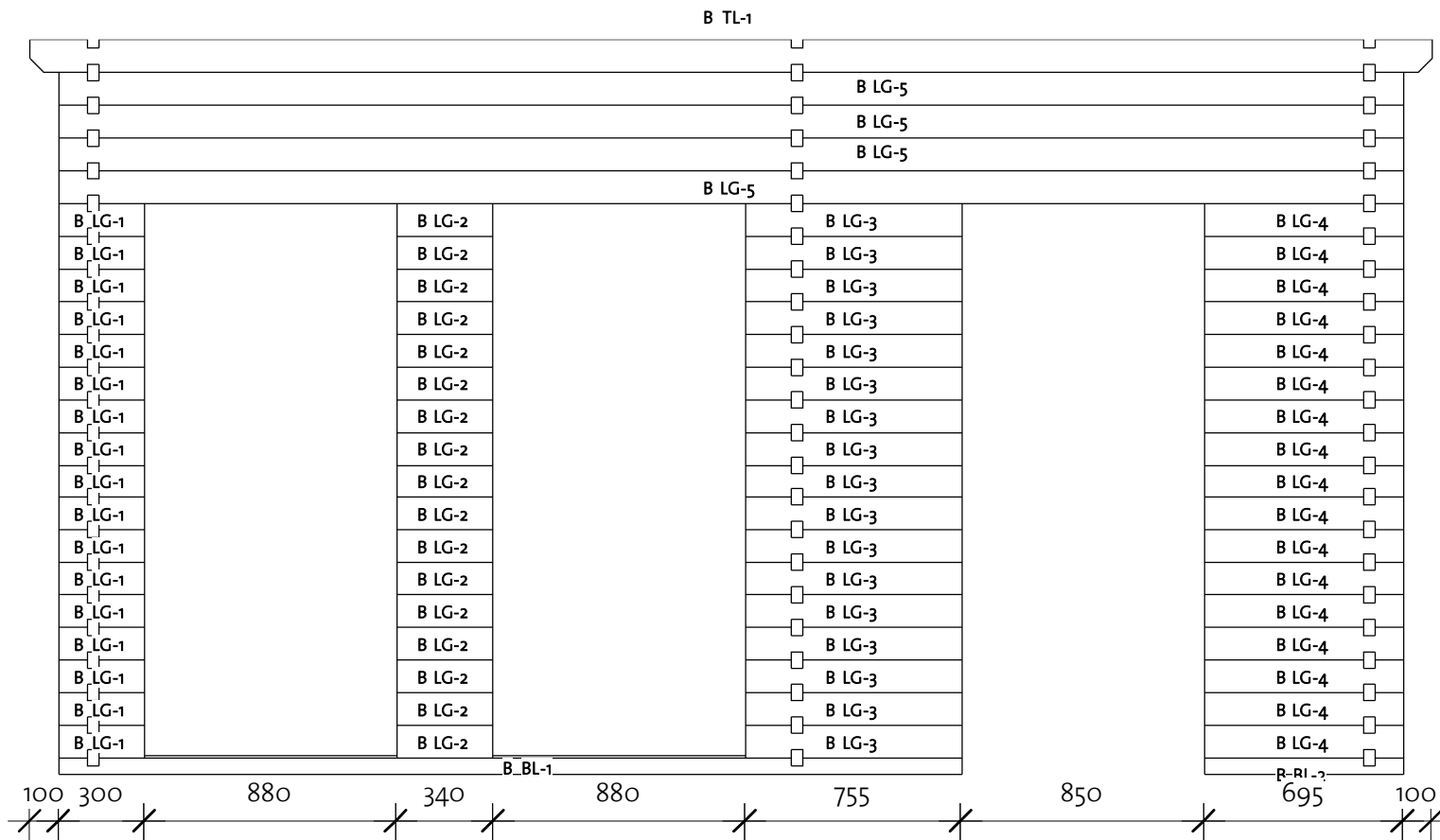

Log Profile Wall B	
Profile	Profile



40X114	
40X114	
40X57	

92503055\_250916

# Sauna Flat B 40 (250x450)

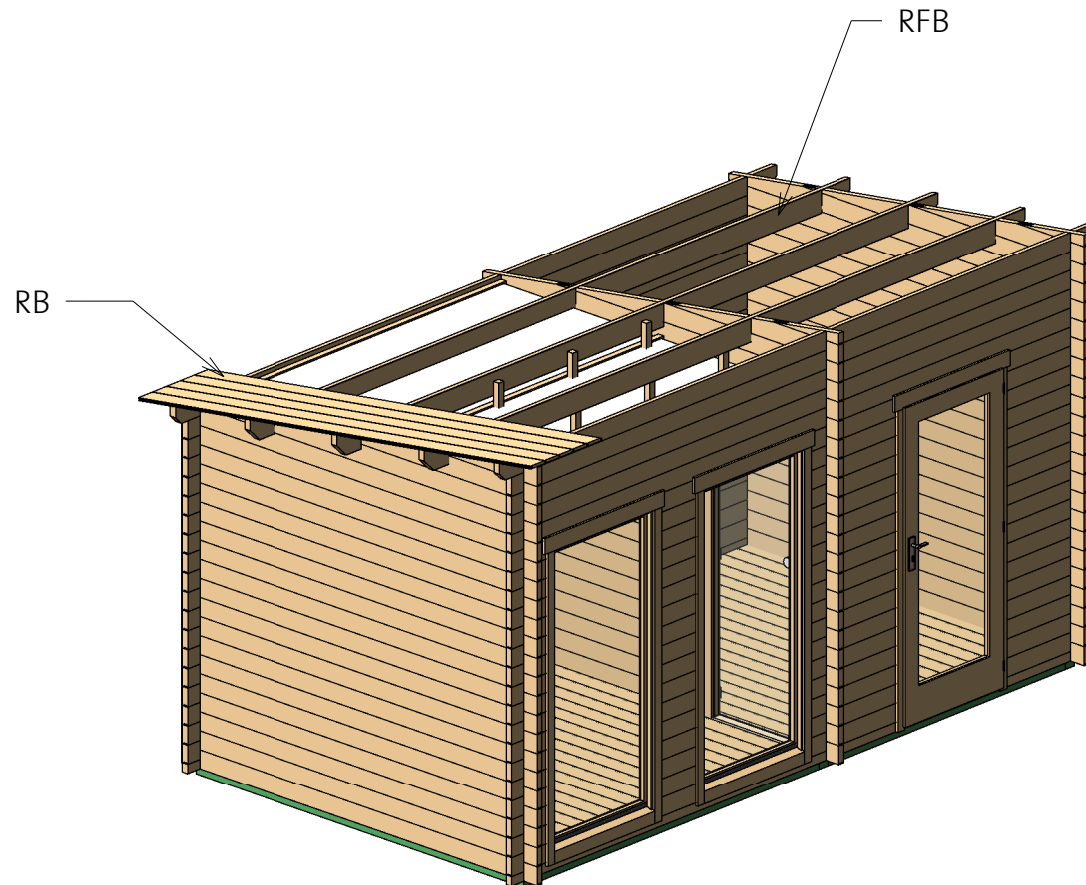
Roof 1



Roof				
Mark	Type	Profile	Count	Length
RB	17x114		44	3006
RFB	Beam 40x143		3	4900

# Sauna Flat B 40 (250x450)

Roof 2

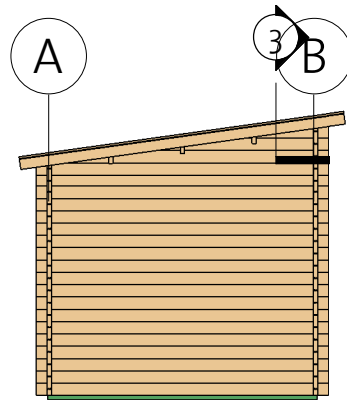
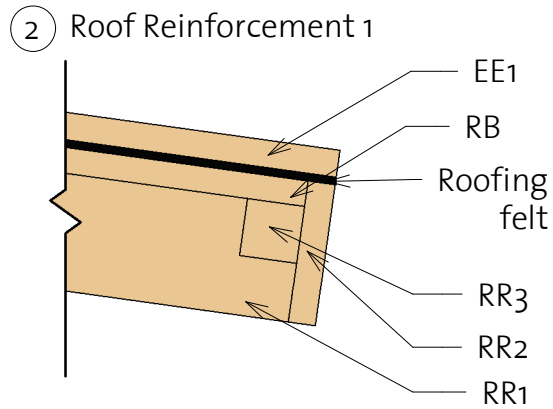
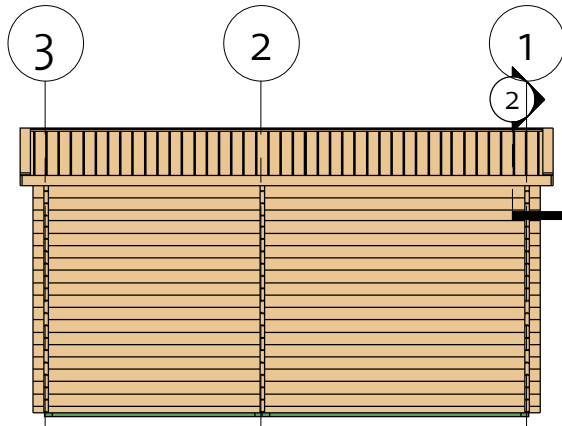

Roof Reinforcement 2

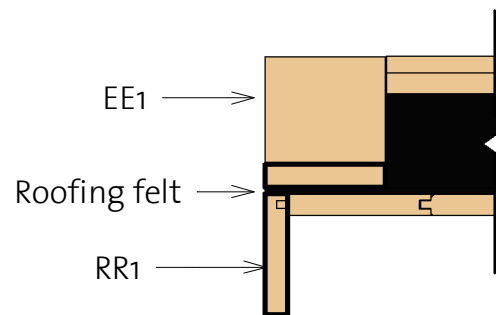



Fascia Schedule				
Mark	Type	Profile	Count	Length
EE1	Eave Edging 18x95		2	3042
EE2	Eave Edging 18x95		1	4742
RR1	Roof reinforcement 18x95		2	3042
RR2	Roof reinforcement 18x95		2	4900
RR3	Roof reinforcement 38x38		2	4900

# Sauna Flat B 40 (250x450)

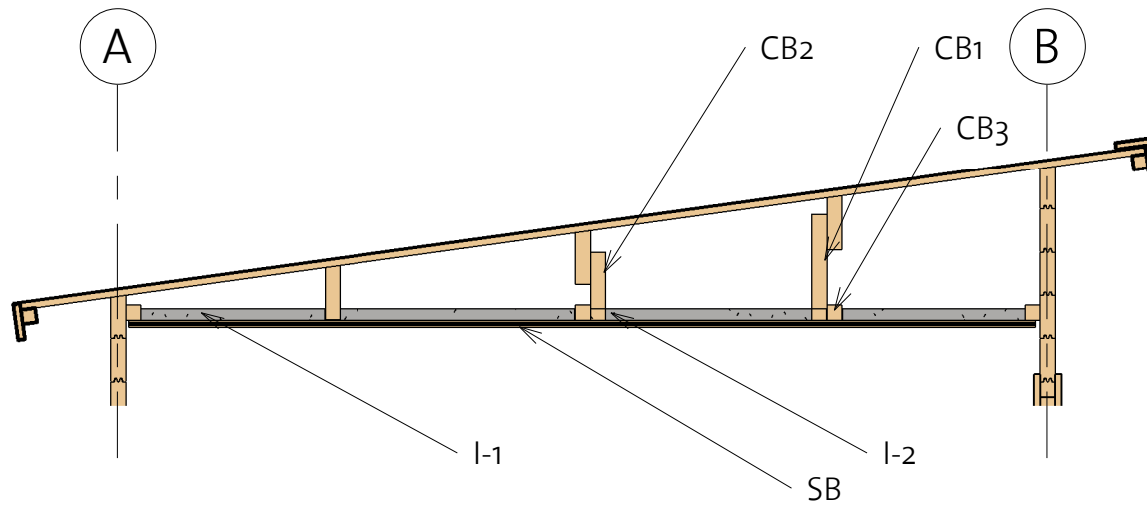
Ceiling



Ceiling Schedule				
Mark	Type	Profile	Count	Length
CB1	40x40		4	280
CB2	40x40		4	180
CB3	40x40		4	2415
SB	15x80		31	2400

Insulation Schedule			
Mark	Type	Count	Length
I-1	Insulation 486	2	2400
I-2	Insulation 622	2	2400

# Sauna Flat B 40 (250x450)

Extras

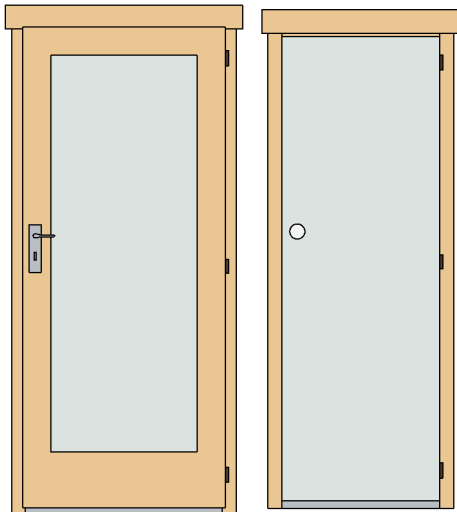

Door Schedule				
Model	Type	Width	Height	Count
SD	Sauna door	685	1920	1
CD6R	Classic door 6 right	840	1955	1

Fasteners/Extras		
Name	Type	Count

Hitblock	300-400 mm	
Screws	5,0 x 70	30
Nails	1,4 x 40	45
Screws	6,0 x 140	60
Screws	4,0 x 40	520

Window Schedule				
Mark	Type	Width	Height	Count
CW4R	Classic window 4, right tempered	875	1890	2

- \* Windows intended for tilt opening only!
- \* Fenster zur Eröffnung nur zum Kippen vorgesehen!
- \* Aknad on ette nähtud ainult kaldu avamiseks!

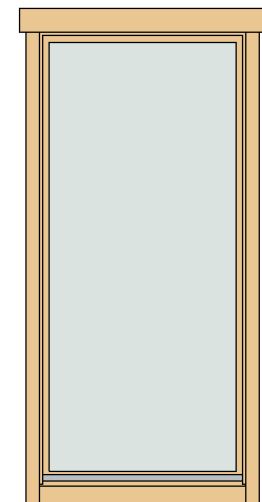

# Sauna Flat B 40 (250x450)

## List of all items 1

### Impregnated foundation beams



Mark	Type	Profile	Count	Length
IFB1	IFB 70x40		4	2490
IFB2	IFB 70x40		5	2335
IFB3	IFB 70x40		5	1875

### Floor Schedule





Mark	Type	Profile	Count	Length
FB	FB 17x114		39	2414

BB1	BB 18x40		6	2500
BB2	BB 18x40		2	2000

### Roof

Mark	Type	Profile	Count	Length
RB	17x114		44	3006
RFB	Beam 40x143		3	4900

### Fascia Schedule

Mark	Type	Profile	Count	Length
EE1	Eave Edging 18x95		2	3042
EE2	Eave Edging 18x95		1	4742
RR1	Roof reinforce ment 18x95		2	3042
RR2	Roof reinforce ment 18x95		2	4900
RR3	Roof reinforce ment 38x38		2	4900

# Sauna Flat B 40 (250X450)

## List of all items 2

Wall 1			
Mark	Profile	Count	Cut Length

1LG-1 *	40X114	1	510
1LG-2 *	40X114	1	1330
1LG-3 *	40X114	1	2150
1LG-4 *	40X114	1	2700
1LG-5	40X114	19	2700

Wall 2			
Mark	Profile	Count	Cut Length

2LG-1 *	40X114	1	510
2LG-2 *	40X114	1	1330
2LG-3 *	40X114	1	2150
2LG-4 *	40X114	1	2700
2LG-5	40X114	2	2700
2LG-6	40X114	17	1710
2LG-7	40X114	17	300

Wall 3			
Mark	Profile	Count	Cut Length

3LG-1 *	40X114	1	510
3LG-2 *	40X114	1	1330
3LG-3 *	40X114	1	2150
3LG-4 *	40X114	1	2700
3LG-5	40X114	19	2700

\* Gable - delivered premounted

Wall A			
Mark	Profile	Count	Cut Length

ABL-1	40X57	1	4700
ALG-1	40X114	18	4700
ATL-1	40X114	1	4900

Wall B			
Mark	Profile	Count	Cut Length

BBL-1	40X57	1	3155
BBL-2	40X57	1	695
BLG-1	40X114	17	300
BLG-2	40X114	17	340
BLG-3	40X114	17	755
BLG-4	40X114	17	695
BLG-5	40X114	4	4700
BTL-1	40X114	1	4900



# Sauna Flat B 40 (250x450)

## List of all items 3



Insulation Schedule			
Mark	Type	Count	Length

I-1	Insulation 486	2	2400
I-2	Insulation 622	2	2400

Ceiling Schedule				
Mark	Type	Profile	Count	Length

CB1	40x40		4	280
CB2	40x40		4	180
CB3	40x40		4	2415
SB	15x80		31	2400

Log profiles	
Profile	Profile

40x57	
40x114	
40x114	