

# Sauna Gable B 40 (98 3/8" x 177 1/8")

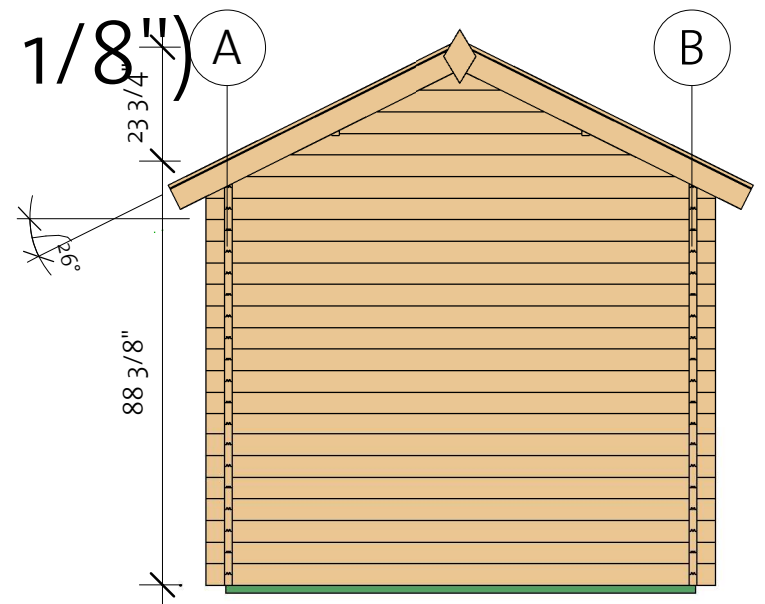
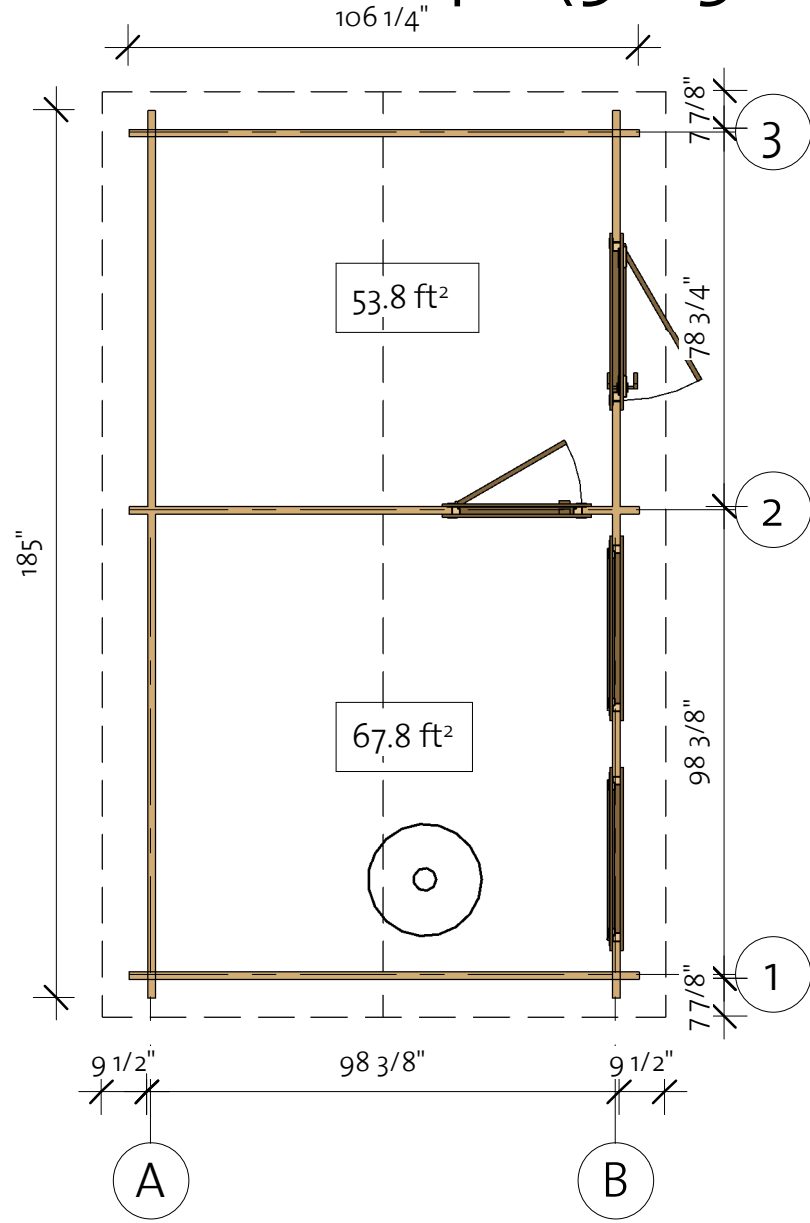

**EZ Log Structures**  
Do-It-Yourself Building Kits

# Sauna Gable B 40 (98 3/8" x 177 1/8")

Foundation

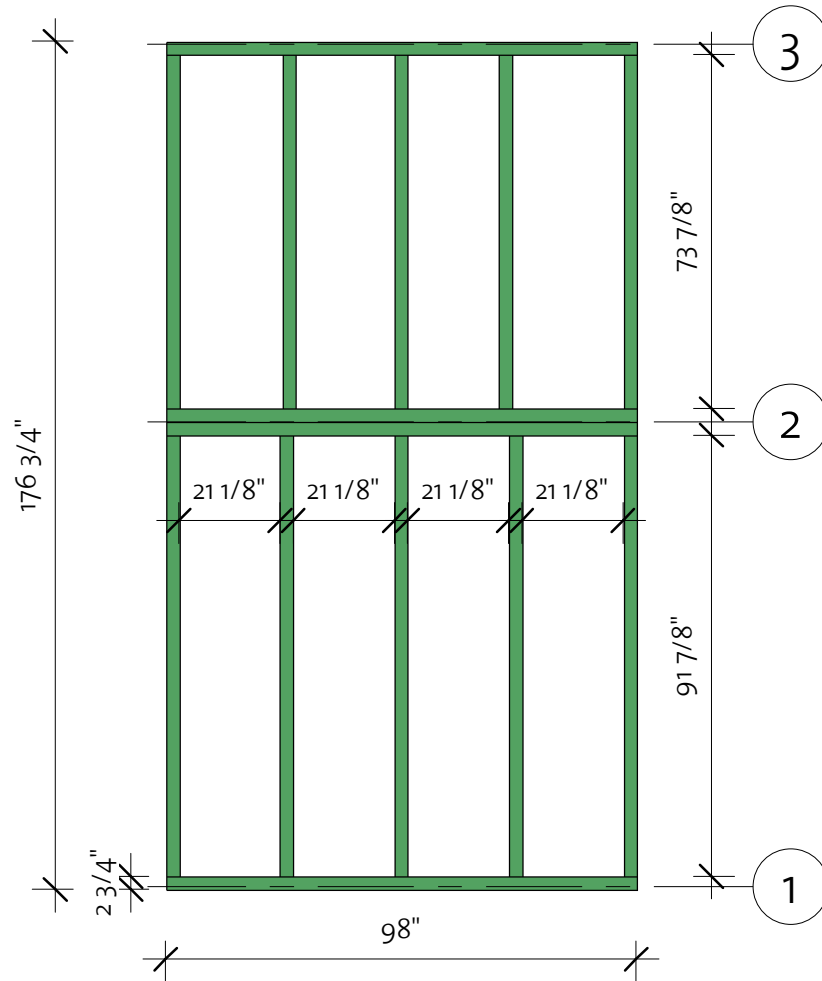



Impregnated foundation beams				
Mark	Type	Profile	Count	Length

IFB1	IFB 70x40		4	98"
IFB2	IFB 70x40		5	91 7/8"
IFB3	IFB 70x40		5	73 7/8"

# Sauna Gable B 40 (98 3/8" x 177 1/8")

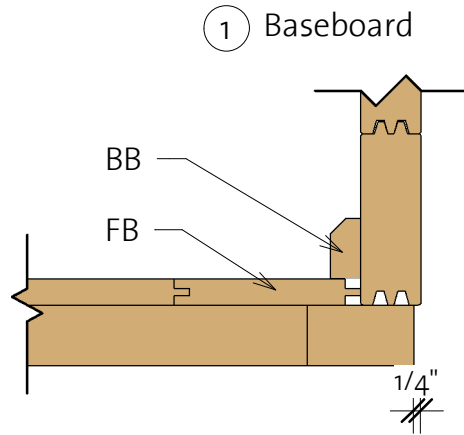
Floor Plan



Floor Schedule				
Mark	Type	Profile	Count	Length
FB	FB 17x114		39	95"
BB1	BB 18x40		6	98 3/8"
BB2	BB 18x40		2	78 3/4"

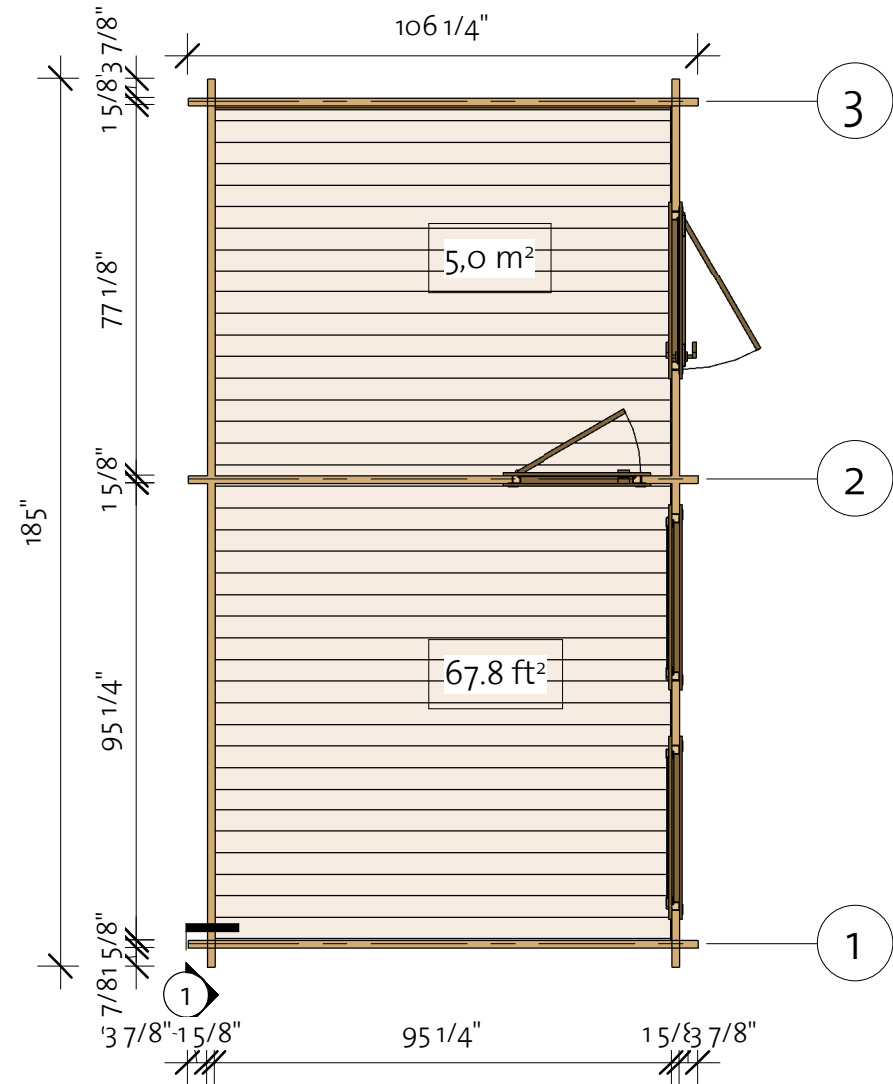

# Sauna Gable B 40 (98 3/8" x 177 1/8")

Wall 1

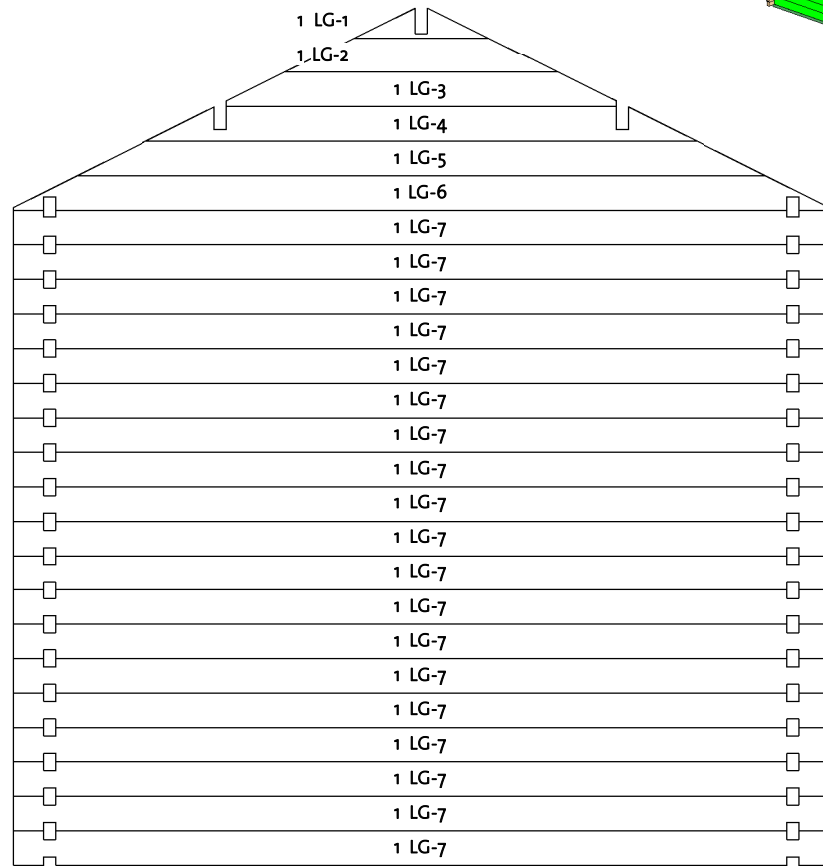
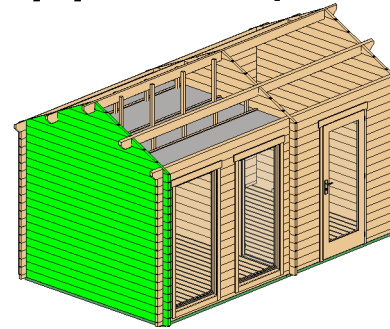

Wall 1			
Mark	Profile	Count	Cut Length

1LG-1 *	40X114	1	17 3/8"
1LG-2 *	40X114	1	35 1/2"
1LG-3 *	40X114	1	50 5/8"
1LG-4 *	40X114	1	71 1/2"
1LG-5 *	40X114	1	89 5/8"
1LG-6 *	40X114	1	106 1/4"
1LG-7	40X114	19	106 1/4"

\* Gable - delivered premounted

Log Profile Wall 1

Profile

Profile

40X114

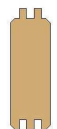

# Sauna Gable B 40 (98 3/8" x 177 1/8")

Wall 2

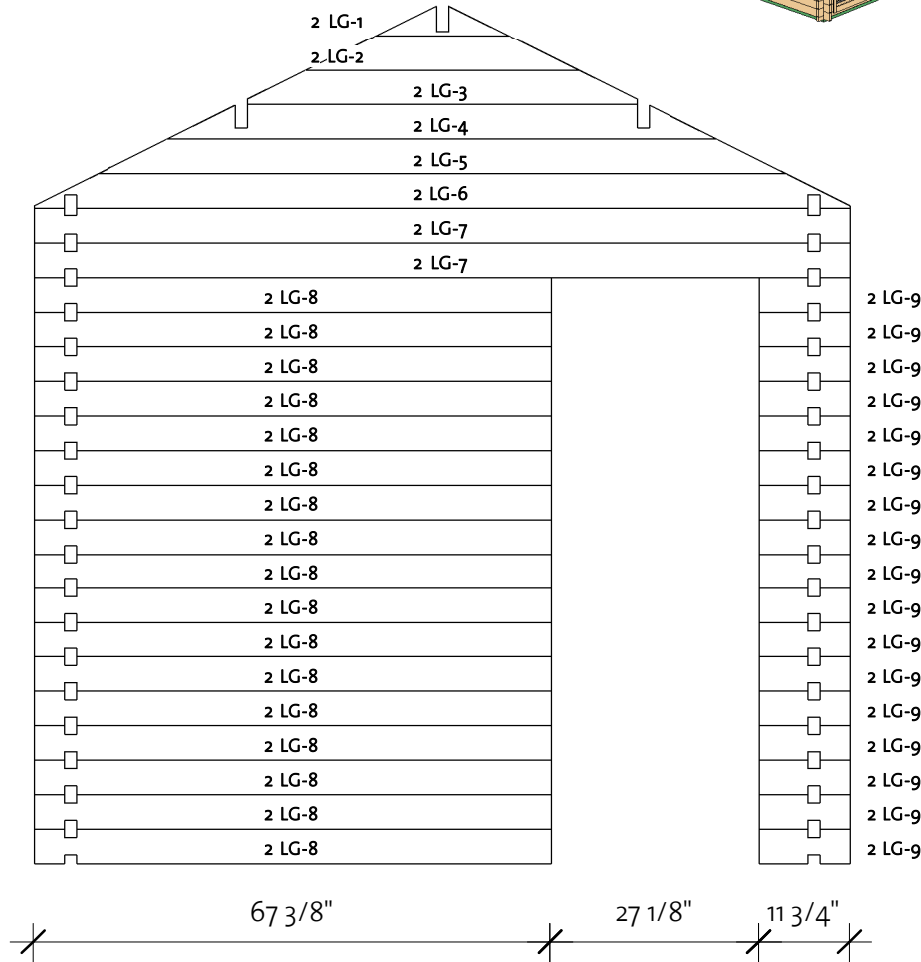
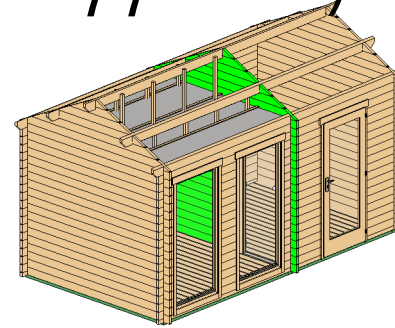

Wall 2			
Mark	Profile	Count	Cut Length

2LG-1 *	40X114	1	17 3/8"
2LG-2 *	40X114	1	35 1/2"
2LG-3 *	40X114	1	50 5/8"
2LG-4 *	40X114	1	71 1/2"
2LG-5 *	40X114	1	89 5/8"
2LG-6 *	40X114	1	106 1/4"
2LG-7	40X114	2	106 1/4"
2LG-8	40X114	17	67 3/8"
2LG-9	40X114	17	11 3/4"

\* Gable - delivered premounted

Log Profile Wall 2	
Profile	Profile

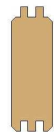
40X114	
--------	---

# Sauna Gable B 40 (98 3/8" x 177 1/8")

Wall 3

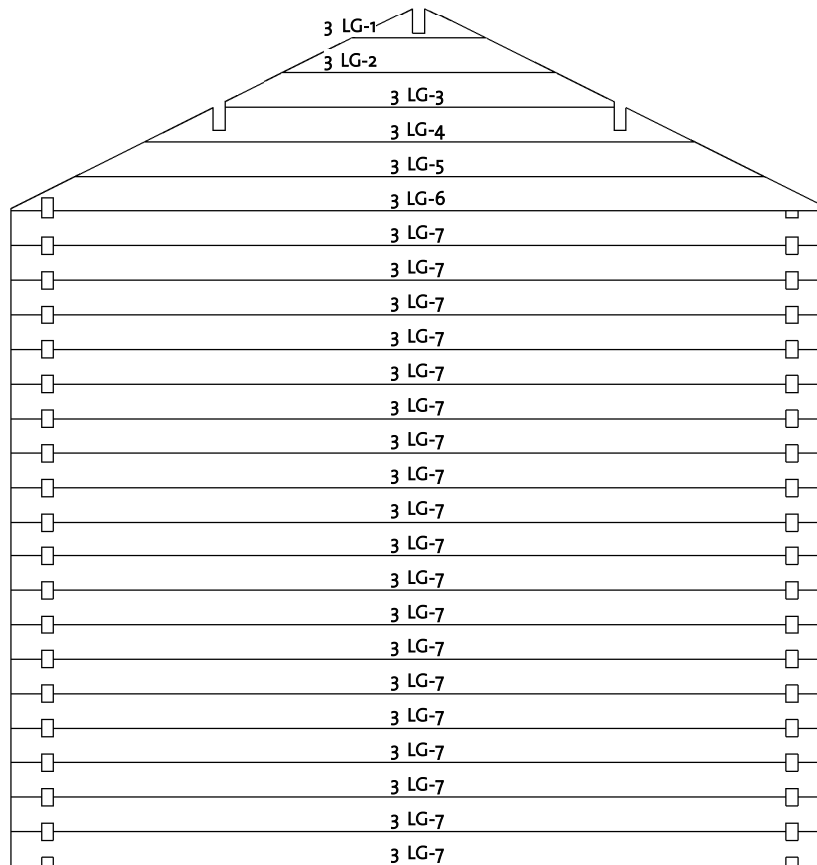
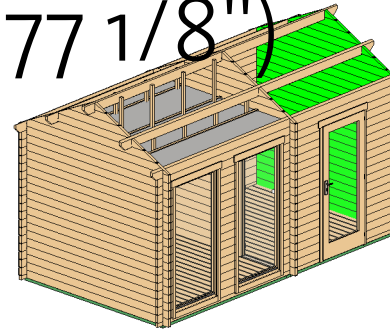

Wall 3			
Mark	Profile	Count	Cut Length

3LG-1 *	40x114	1	17 3/8"
3LG-2 *	40x114	1	35 1/2"
3LG-3 *	40x114	1	50 5/8"
3LG-4 *	40x114	1	71 1/2"
3LG-5 *	40x114	1	89 5/8"
3LG-6 *	40x114	1	106 1/4"
3LG-7	40x114	19	106 1/4"

\* Gable - delivered premounted

Log Profile Wall 3	
Profile	Profile

40x114	
--------	--

# Sauna Gable B 40 (98 3/8" x 177 1/8")

Wall A

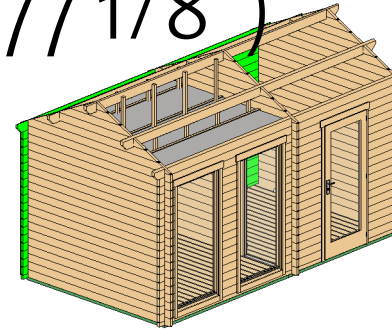

Wall A			
Mark	Profile	Count	Cut Length

ABL-1	40x57	1	185"
ALG-1	40x114	18	185"
ATL-1	40x135	1	192 7/8"

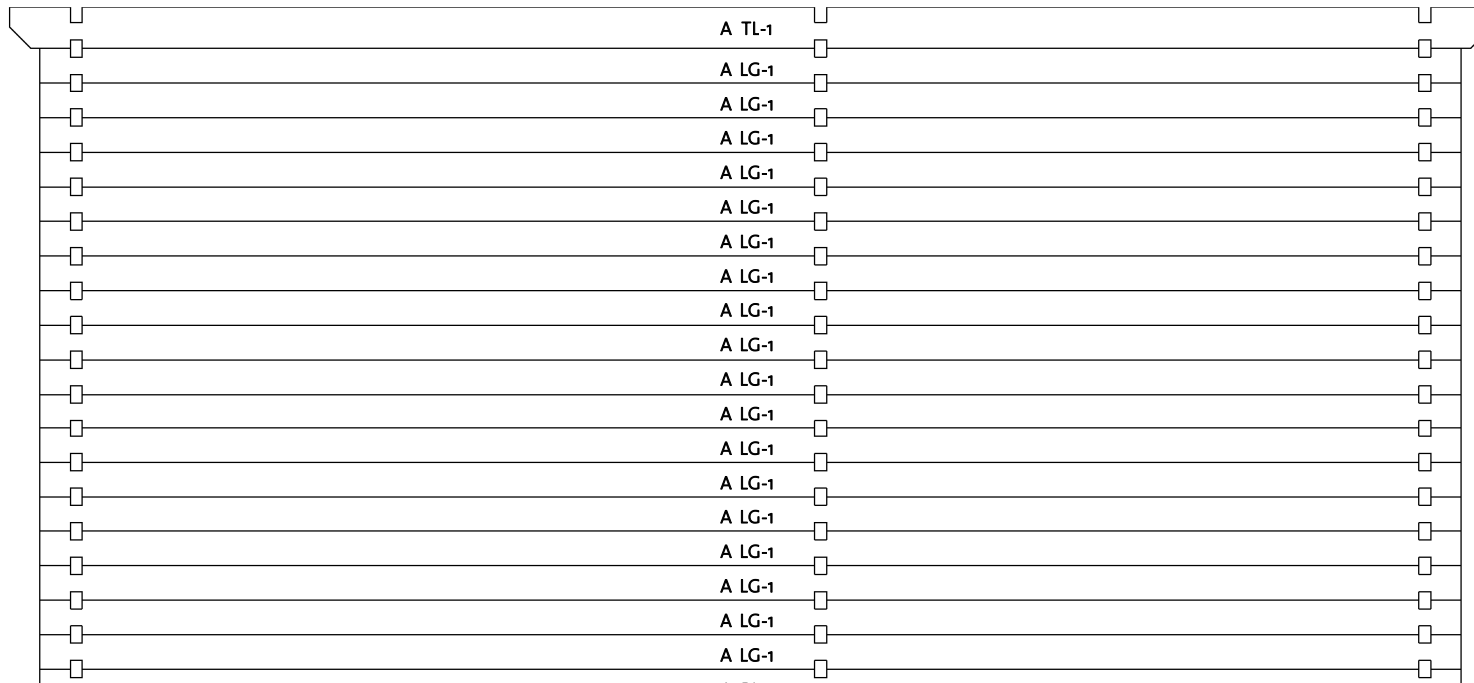

3 7/8"  
//

185"

3 7/8"  
//

Log Profile Wall A	
Profile	Profile

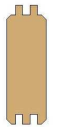
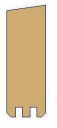
40x57	
40x114	
40x135	

# Sauna Gable B 40 (98 3/8" x 177 1/8")

Wall B

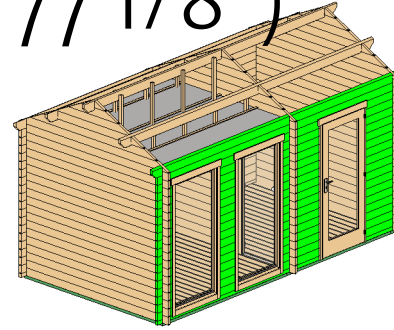

Wall B			
Mark	Profile	Count	Cut Length

BBL-1	40X57	1	124 1/4"
BBL-2	40X57	1	27 3/8"
BLG-1	40X114	17	11 3/4"
BLG-2	40X114	17	13 3/8"
BLG-3	40X114	17	29 3/4"
BLG-4	40X114	17	27 3/8"
BLG-5	40X114	1	185"
BTL-1	40X135	1	192 7/8"

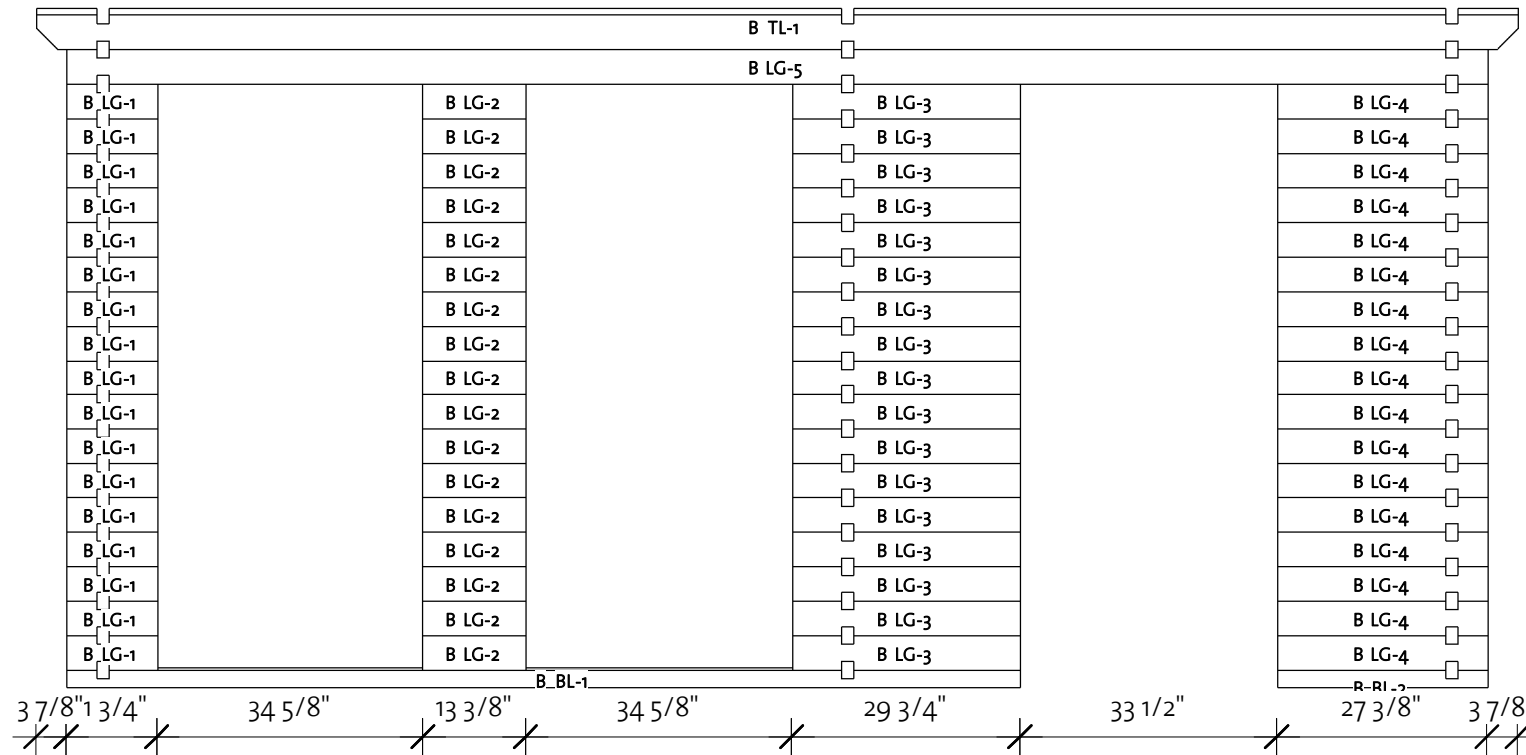

Log Profile Wall B	
Profile	Profile



40X135	
40X114	
40X57	

# Sauna Gable B 40 (98 3/8" x 177 1/8")

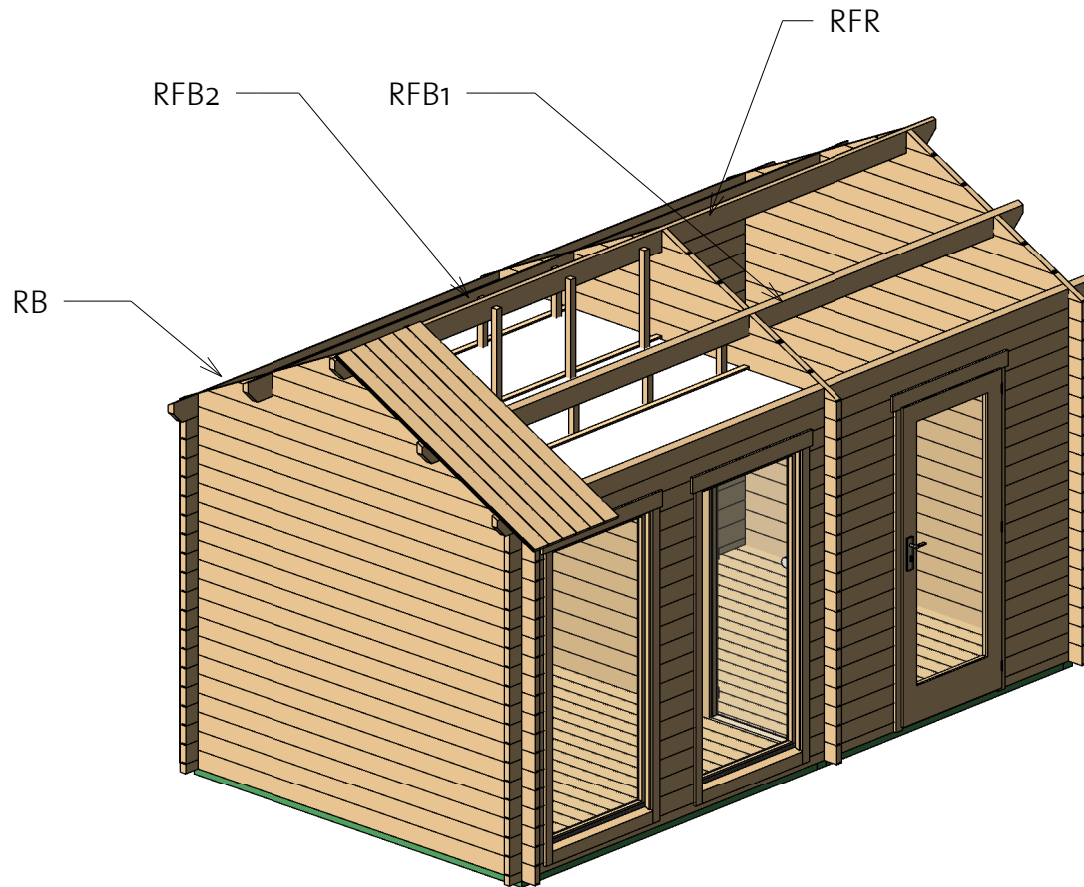
Roof 1

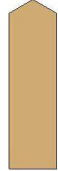

Roof				
Mark	Type	Profile	Count	Length

RB	17x114		88	66"
RFB1	Beam 40x143		1	192 7/8"
RFB2	Beam 40x143		1	192 7/8"
RFR	Ridge 40x143		1	192 7/8"

# Sauna Gable B 40 (98 3/8" x 177 1/8")

Roof 2

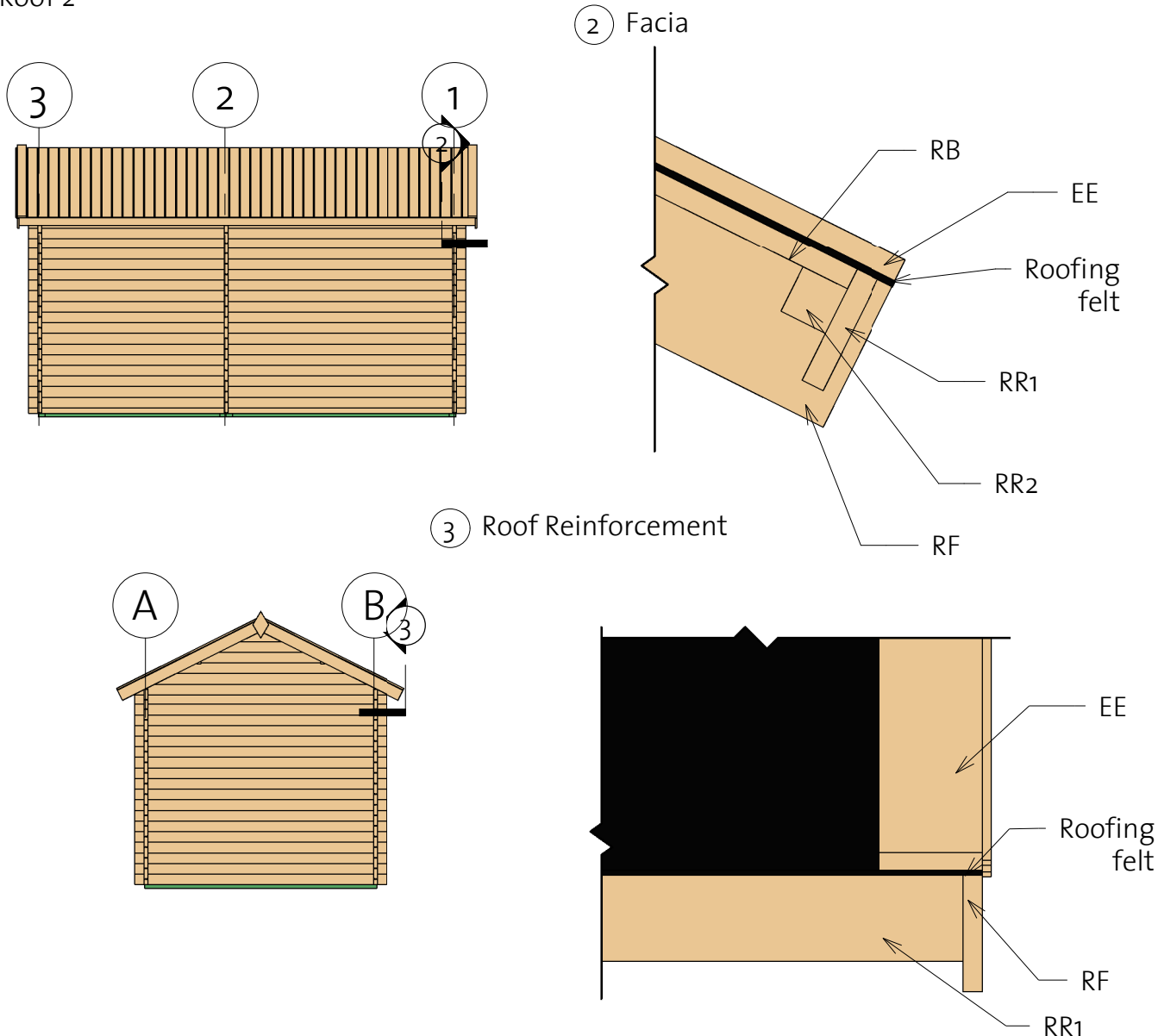



Fascia Schedule				
Mark	Type	Profile	Count	Length
EE	Eave Edging 18x95		4	67 5/8"
RF	Roof Fascia 18x120		4	67 5/8"
RR1	Roof reinforcement 18x95		2	192 7/8"
RR2	Roof reinforcement 38x38		2	192 7/8"

# Sauna Gable B 40 (98 3/8" x 177 1/8")

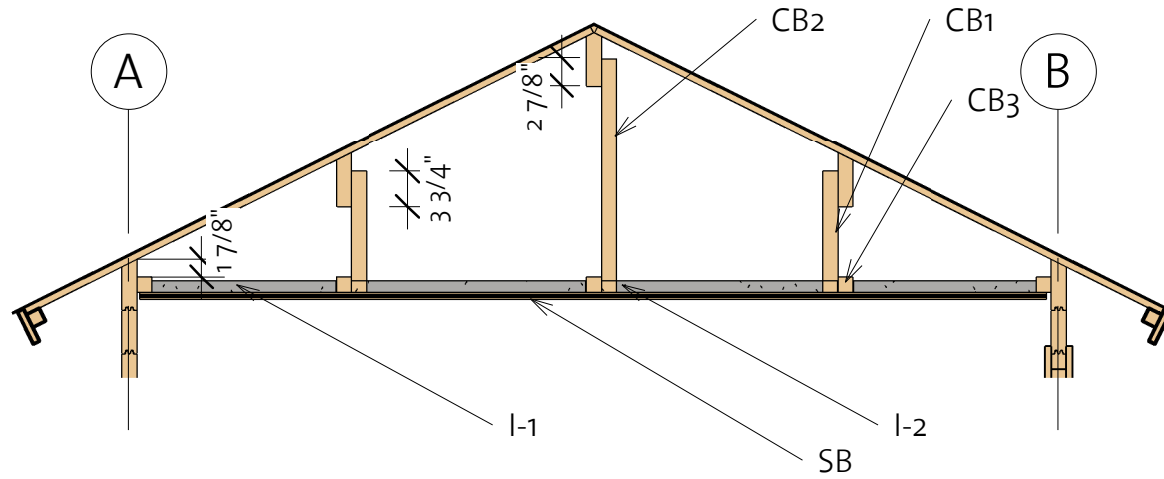
Ceiling



Ceiling Schedule

Mark	Type	Profile	Count	Length
CB1	40x40		8	12 5/8"
CB2	40x40		4	24 3/8"
CB3	40x40		5	95 1/8"
SB	15x80		31	94 1/2"

Insulation Schedule

Mark	Type	Count	Length
I-1	Insulation 486	2	94 1/2"
I-2	Insulation 622	2	94 1/2"

# Sauna Gable B 40 (98 3/8" x 177 1/8")

Extras

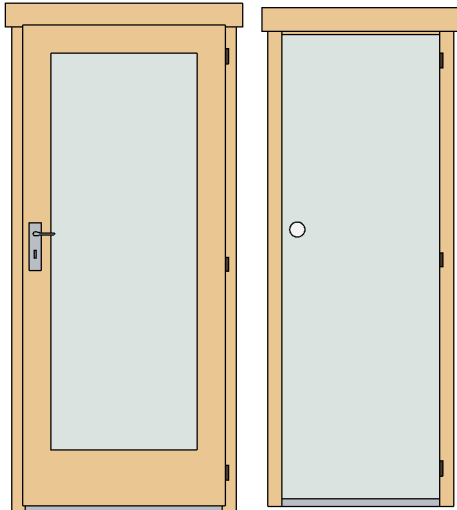

Door Schedule				
Model	Type	Width	Height	Count
SD	Sauna door	27"	75 5/8"	1
CD6R	Classic door 6 right	33 1/8"	77"	1

Type	Count
------	-------

Romb	2
------	---



Fasteners/Extras		
Name	Type	Count

Hitblock	300-400 mm	
Screws	5,0 x 70	30
Nails	1,4 x 40	45
Screws	6,0 x 140	60
Screws	4,0 x 40	650

Window Schedule				
Mark	Type	Width	Height	Count
CW4R	Classic window 4, right tempered	34 1/2"	74 3/8"	2

- \* Windows intended for tilt opening only!
- \* Fenster zur Eröffnung nur zum Kippen vorgesehen!
- \* Aknad on ette nähtud ainult kaldu avamiseks!

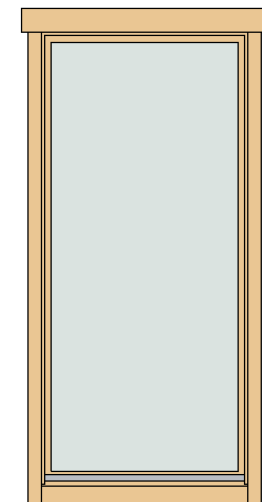

# Sauna Gable B 40 (98 3/8" x 177 1/8")

## List of all items 1

### Impregnated foundation beams



Mark	Type	Profile	Count	Length
IFB1	IFB 70x40		4	98"
IFB2	IFB 70x40		5	91 7/8"
IFB3	IFB 70x40		5	73 7/8"

### Floor Schedule





Mark	Type	Profile	Count	Length
FB	FB 17x114		39	95"

BB1	BB 18x40		6	98 3/8"
BB2	BB 18x40		2	78 3/4"

### Roof

Mark	Type	Profile	Count	Length
RB	17x114		88	66"
RFB1	Beam 40x143		1	192 7/8"
RFB2	Beam 40x143		1	192 7/8"
RFR	Ridge 40x143		1	192 7/8"

### Fascia Schedule

Mark	Type	Profile	Count	Length
EE	Eave Edging 18x95		4	67 5/8"
RF	Roof Fascia 18x120		4	67 5/8"
RR1	Roof reinforce ment 18x95		2	192 7/8"
RR2	Roof reinforce ment 38x38		2	192 7/8"

# Sauna Gable B 40 (98 3/8" x 177 1/8")

## List of all items 2

Wall 1			
Mark	Profile	Count	Cut Length

1LG-1 *	40X114	1	17 3/8"
1LG-2 *	40X114	1	35 1/2"
1LG-3 *	40X114	1	50 5/8"
1LG-4 *	40X114	1	71 1/2"
1LG-5 *	40X114	1	89 5/8"
1LG-6 *	40X114	1	106 1/4"
1LG-7	40X114	19	106 1/4"

Wall 3			
Mark	Profile	Count	Cut Length

3LG-1 *	40X114	1	17 3/8"
3LG-2 *	40X114	1	35 1/2"
3LG-3 *	40X114	1	50 5/8"
3LG-4 *	40X114	1	71 1/2"
3LG-5 *	40X114	1	89 5/8"
3LG-6 *	40X114	1	106 1/4"
3LG-7	40X114	19	106 1/4"

Wall A			
Mark	Profile	Count	Cut Length

ABL-1	40X57	1	185"
ALG-1	40X114	18	185"
ATL-1	40X135	1	192 7/8"

Wall 2			
Mark	Profile	Count	Cut Length

2LG-1 *	40X114	1	17 3/8"
2LG-2 *	40X114	1	35 1/2"
2LG-3 *	40X114	1	50 5/8"
2LG-4 *	40X114	1	71 1/2"
2LG-5 *	40X114	1	89 5/8"
2LG-6 *	40X114	1	106 1/4"
2LG-7	40X114	2	106 1/4"
2LG-8	40X114	17	67 3/8"
2LG-9	40X114	17	11 3/4"

\* Gable - delivered premounted

Wall B			
Mark	Profile	Count	Cut Length

BBL-1	40X57	1	124 1/4"
BBL-2	40X57	1	27 3/8"
BLG-1	40X114	17	11 3/4"
BLG-2	40X114	17	13 3/8"
BLG-3	40X114	17	29 3/4"
BLG-4	40X114	17	27 3/8"
BLG-5	40X114	1	185"
BTL-1	40X135	1	192 7/8"

# Sauna Gable B 40 (98 3/8"x177 1/8")



## List of all items 3



Insulation Schedule			
Mark	Type	Count	Length

I-1	Insulation 486	2	94 1/2"
I-2	Insulation 622	2	94 1/2"

Log profiles	
Profile	Profile

Ceiling Schedule				
Mark	Type	Profile	Count	Length

CB1	40x40		8	12 5/8"
CB2	40x40		4	24 3/8"
CB3	40x40		5	95 1/8"
SB	15x80		31	94 1/2"

40x57	
40x135	
40x114	