

Sauna Gable B 40 (250x450)

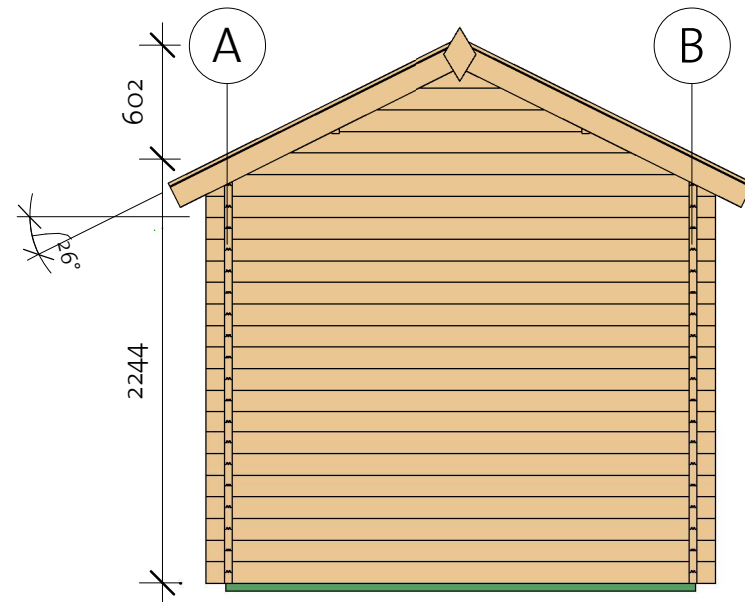

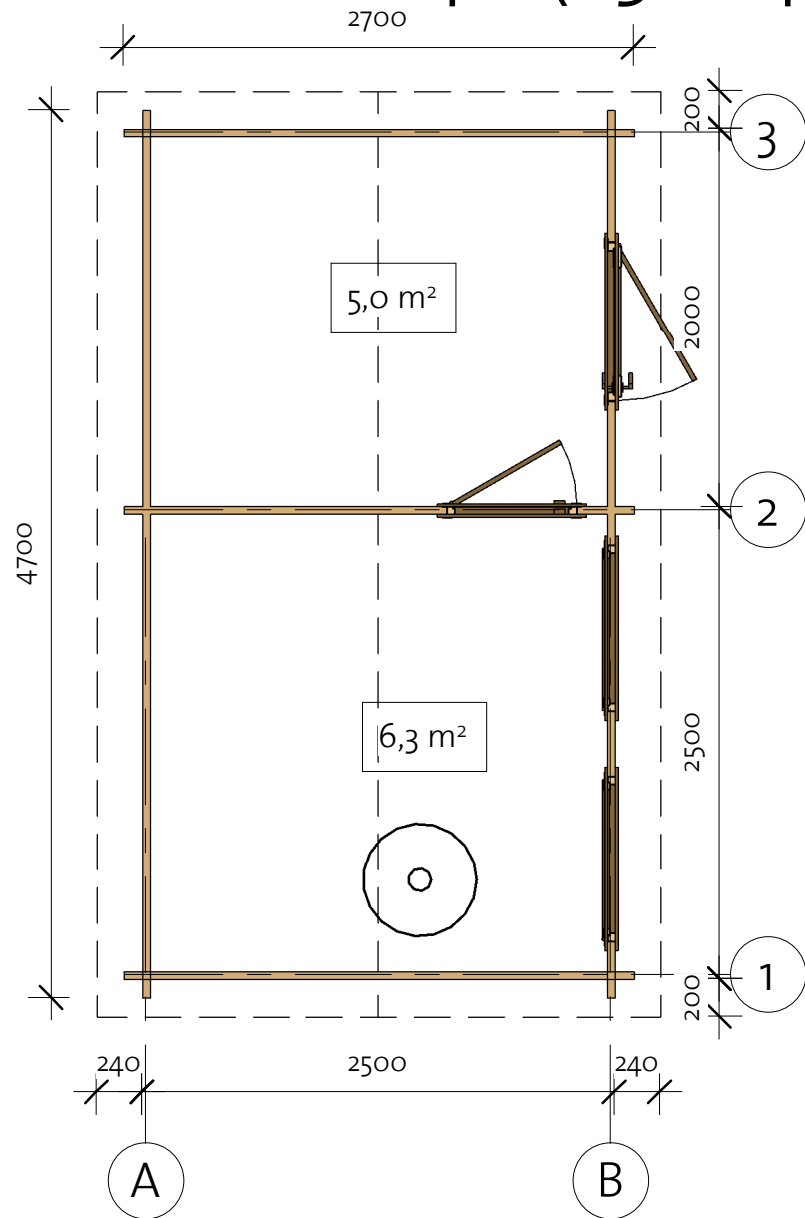

92503058_250821

EZ Log Structures
Do-It-Yourself Building Kits

Sauna Gable B 40 (250x450)

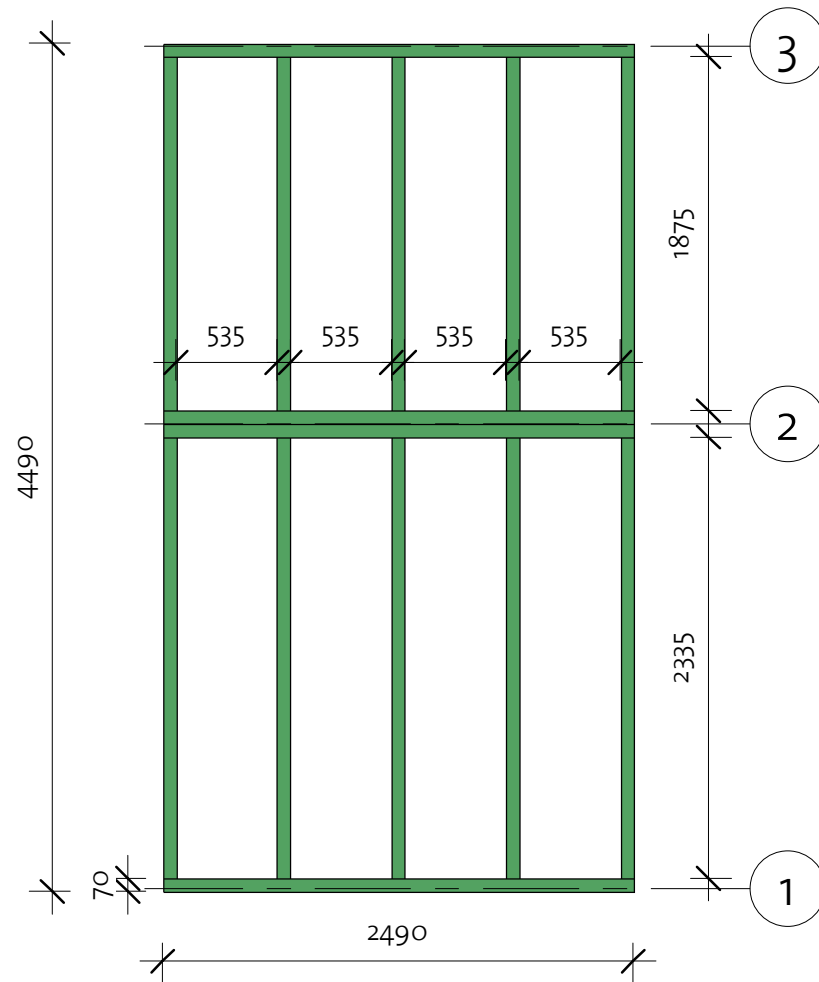
Foundation



Impregnated foundation beams				
Mark	Type	Profile	Count	Length
IFB1	IFB 70x40		4	2490
IFB2	IFB 70x40		5	2335
IFB3	IFB 70x40		5	1875

Sauna Gable B 40 (250x450)

Floor Plan

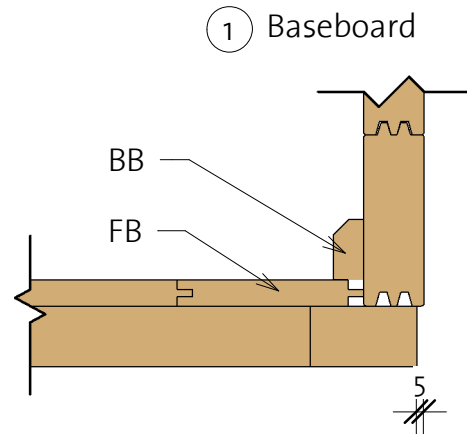

Floor Schedule				
Mark	Type	Profile	Count	Length

FB	FB 17x114		39	2414
----	-----------	---	----	------

BB1	BB 18x40		6	2500
BB2	BB 18x40		2	2000

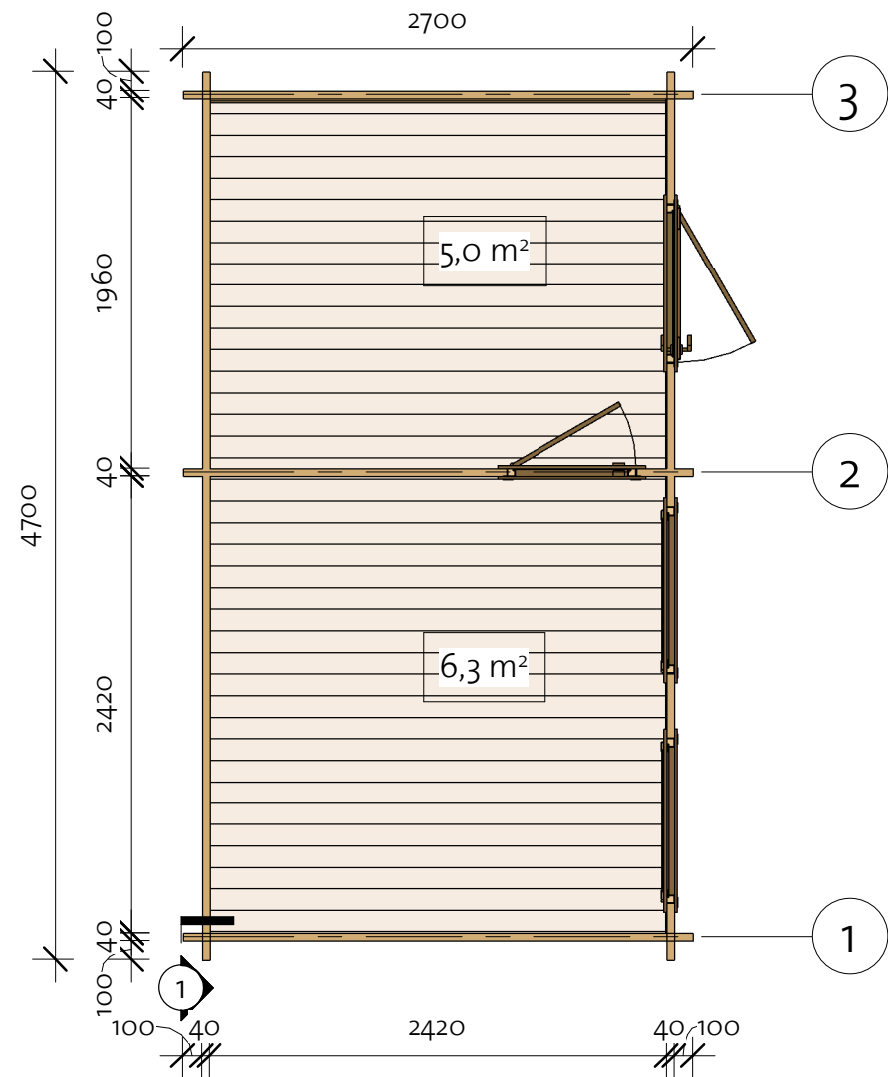

Sauna Gable B 40 (250x450)

Wall 1

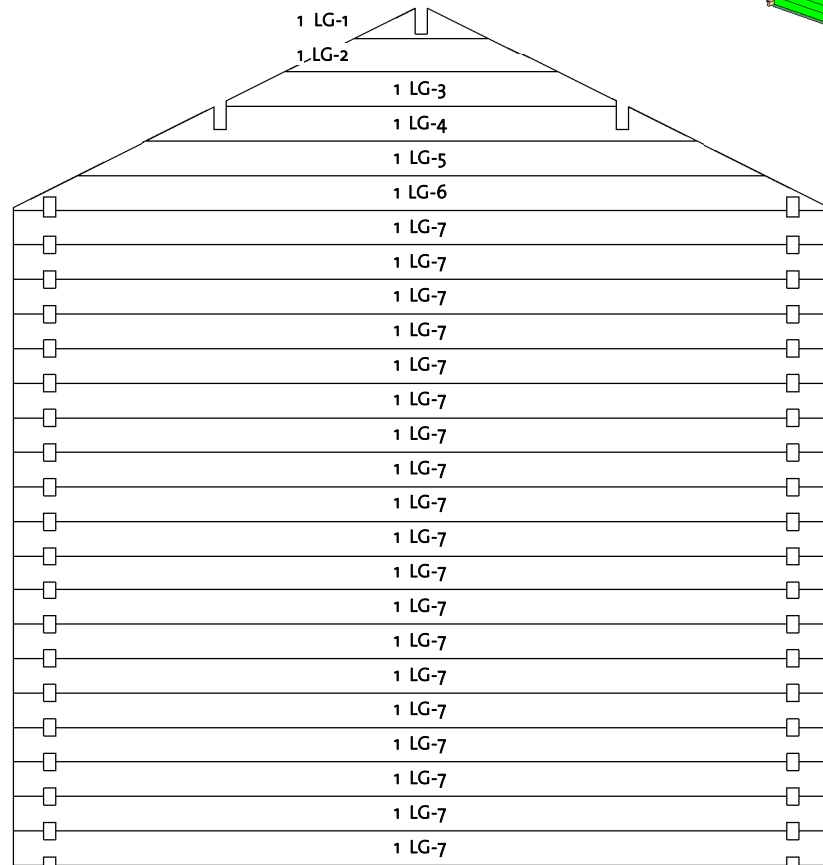
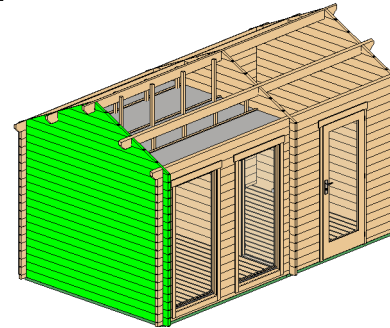

Wall 1			
Mark	Profile	Count	Cut Length

1LG-1 *	40X114	1	442
1LG-2 *	40X114	1	901
1LG-3 *	40X114	1	1287
1LG-4 *	40X114	1	1817
1LG-5 *	40X114	1	2275
1LG-6 *	40X114	1	2700
1LG-7	40X114	19	2700

* Gable - delivered premounted

Log Profile Wall 1

Profile

Profile

40X114

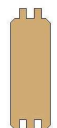

Sauna Gable B 40 (250x450)

Wall 3

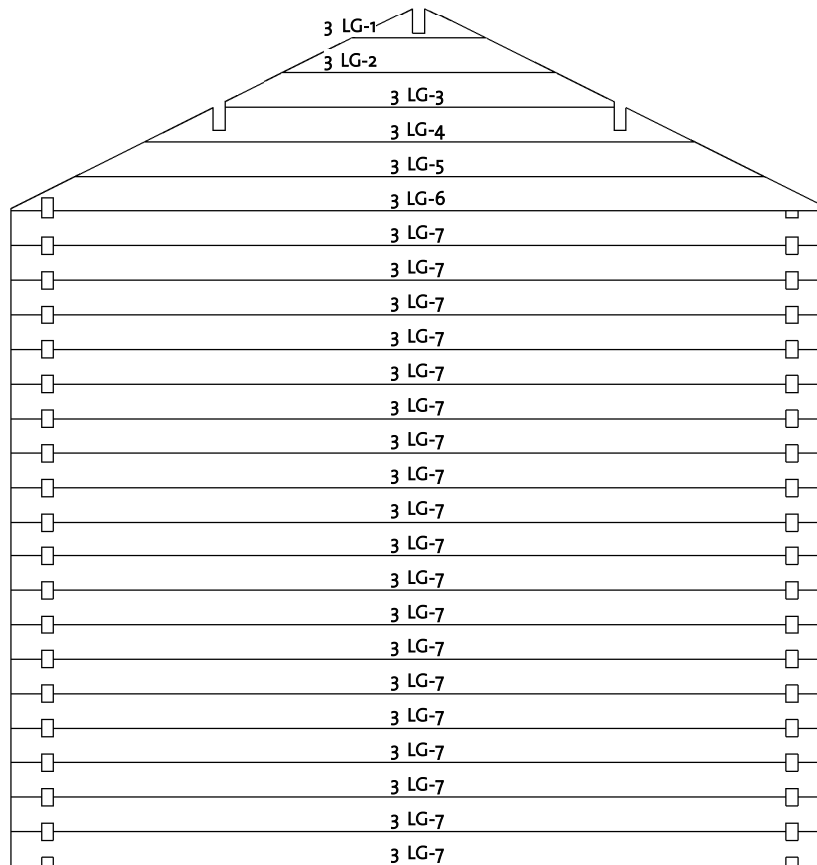
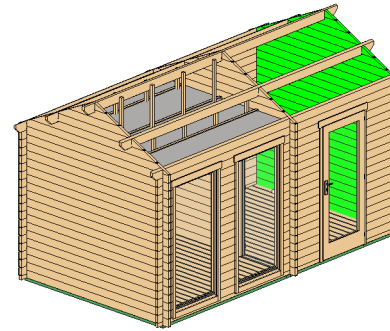

Wall 3			
Mark	Profile	Count	Cut Length

3LG-1 *	40X114	1	442
3LG-2 *	40X114	1	901
3LG-3 *	40X114	1	1287
3LG-4 *	40X114	1	1817
3LG-5 *	40X114	1	2275
3LG-6 *	40X114	1	2700
3LG-7	40X114	19	2700

* Gable - delivered premounted

Log Profile Wall 3	
Profile	Profile

40X114	
--------	--

Sauna Gable B 40 (250x450)

Wall A

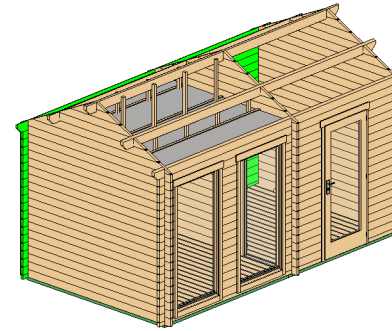

Wall A			
Mark	Profile	Count	Cut Length

ABL-1	40x57	1	4700
ALG-1	40x114	18	4700
ATL-1	40x135	1	4900

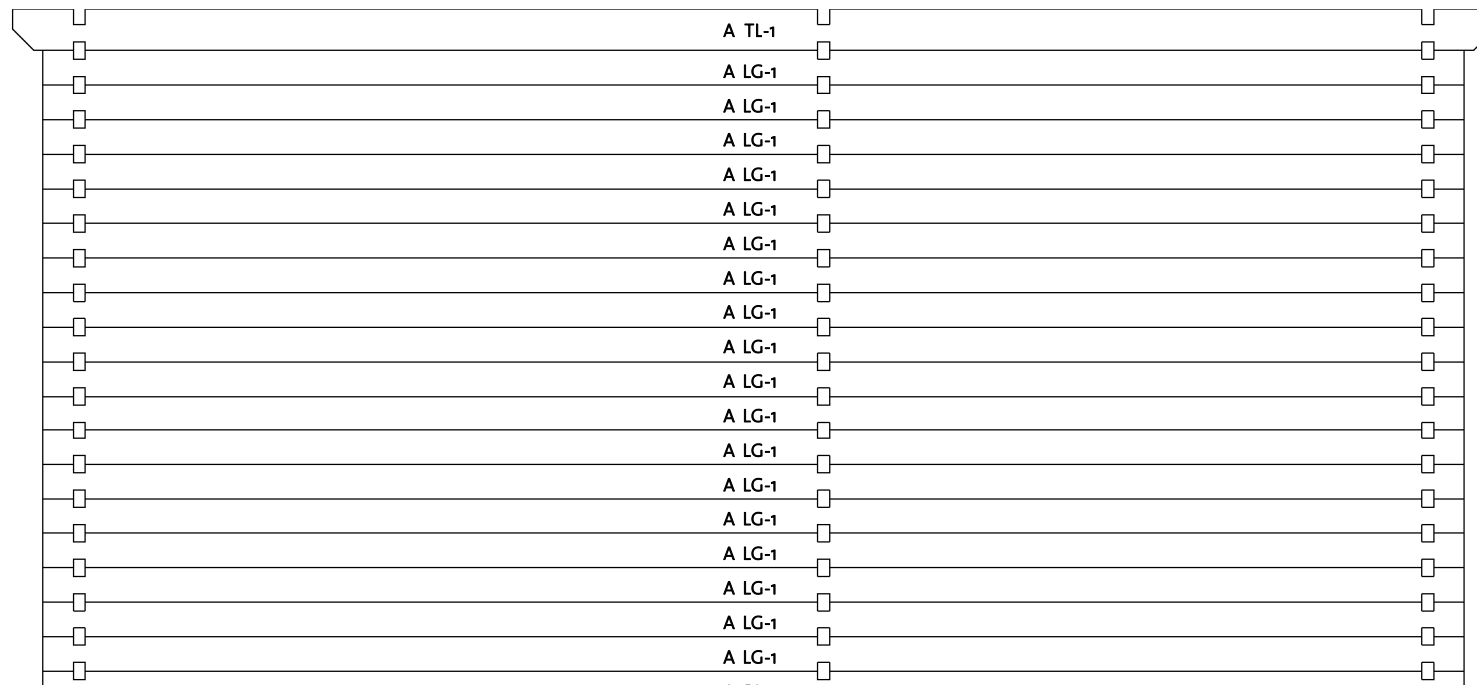

100
//

4700

100
//

Log Profile Wall A	
Profile	Profile

40x57	
40x114	
40x135	

Sauna Gable B 40 (250x450)

Wall B

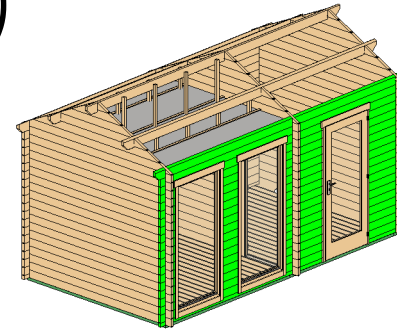

Wall B			
Mark	Profile	Count	Cut Length

BBL-1	40x57	1	3155
BBL-2	40x57	1	695
BLG-1	40x114	17	300
BLG-2	40x114	17	340
BLG-3	40x114	17	755
BLG-4	40x114	17	695
BLG-5	40x114	1	4700
BTL-1	40x135	1	4900

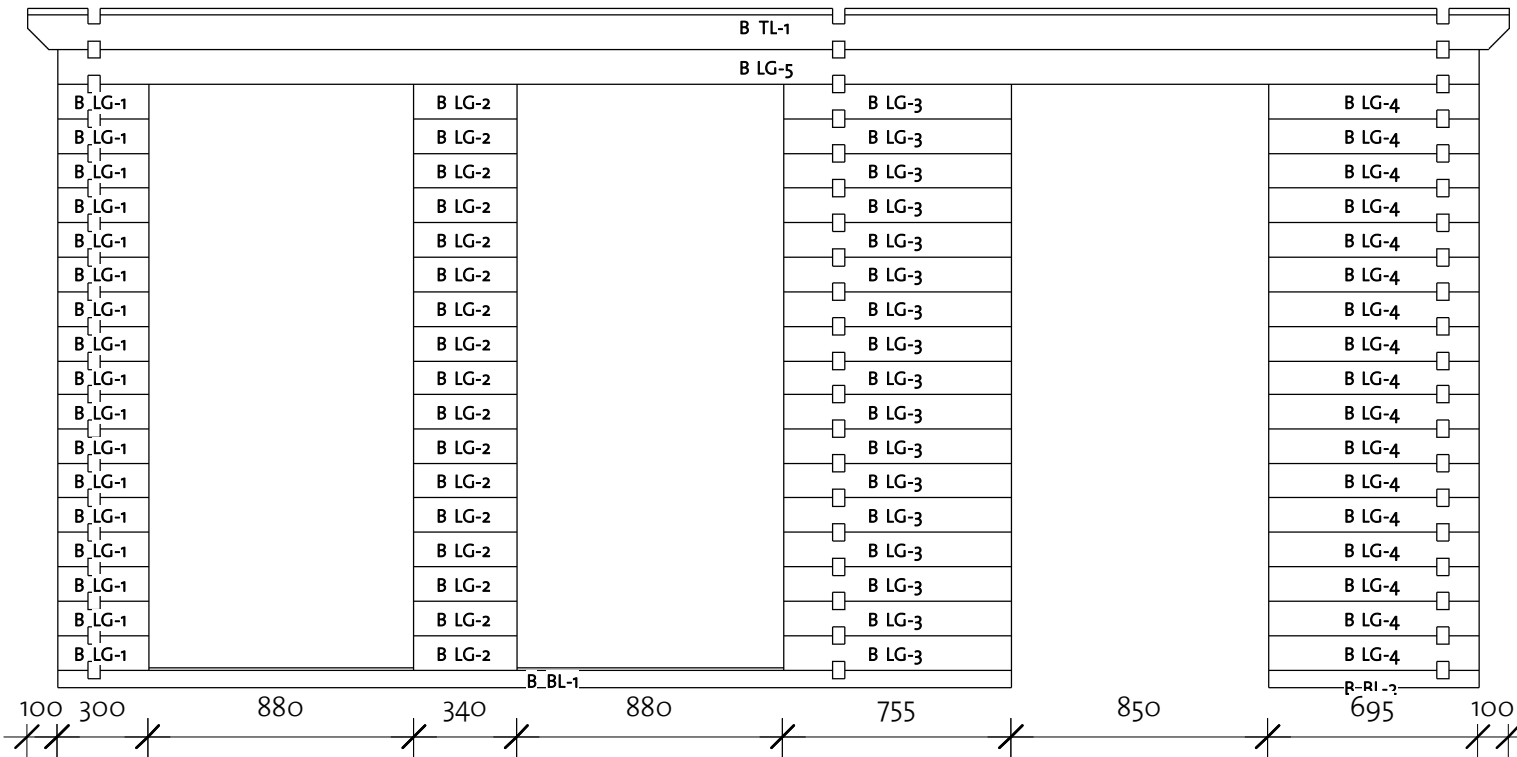





Log Profile Wall B	
Profile	Profile

40x135	
40x114	
40x57	

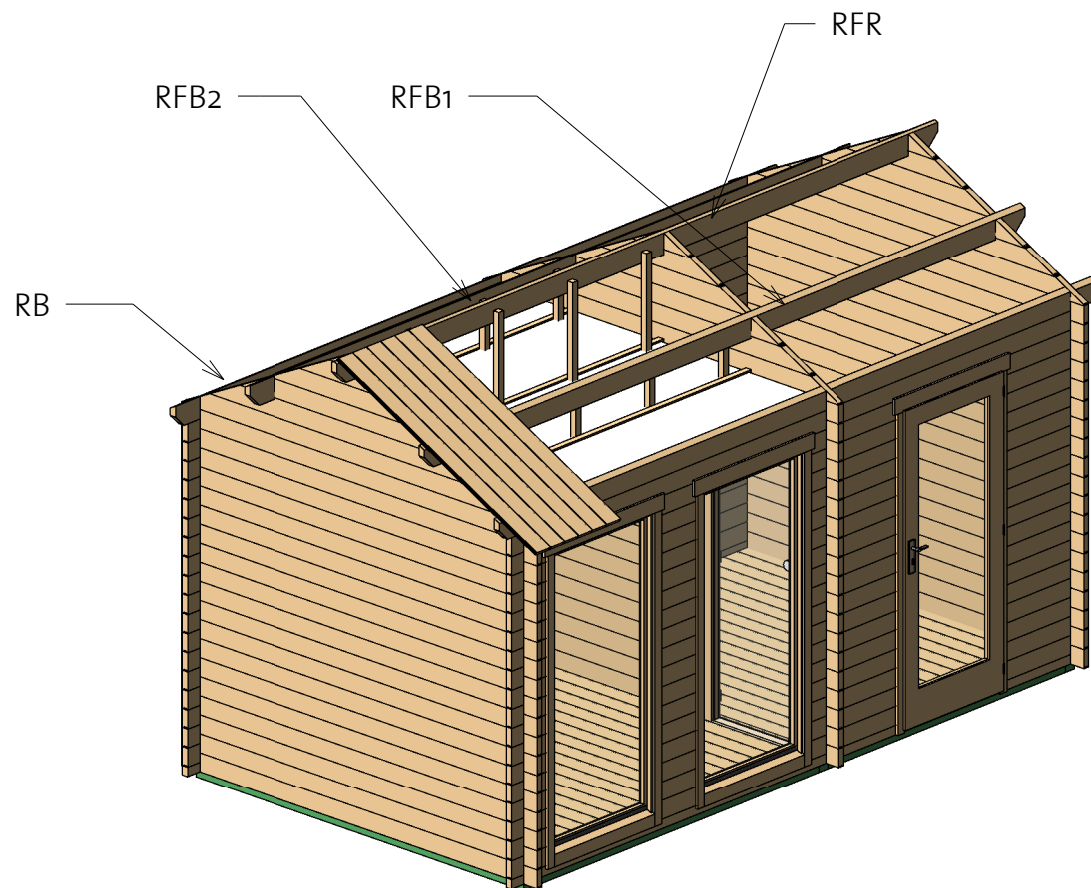
Sauna Gable B 40 (250x450)

Roof 1

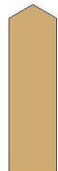

Roof				
Mark	Type	Profile	Count	Length
RB	17x114		88	1677
RFB1	Beam 40x143		1	4900
RFB2	Beam 40x143		1	4900
RFR	Ridge 40x143		1	4900

Sauna Gable B 40 (250x450)

Roof 2

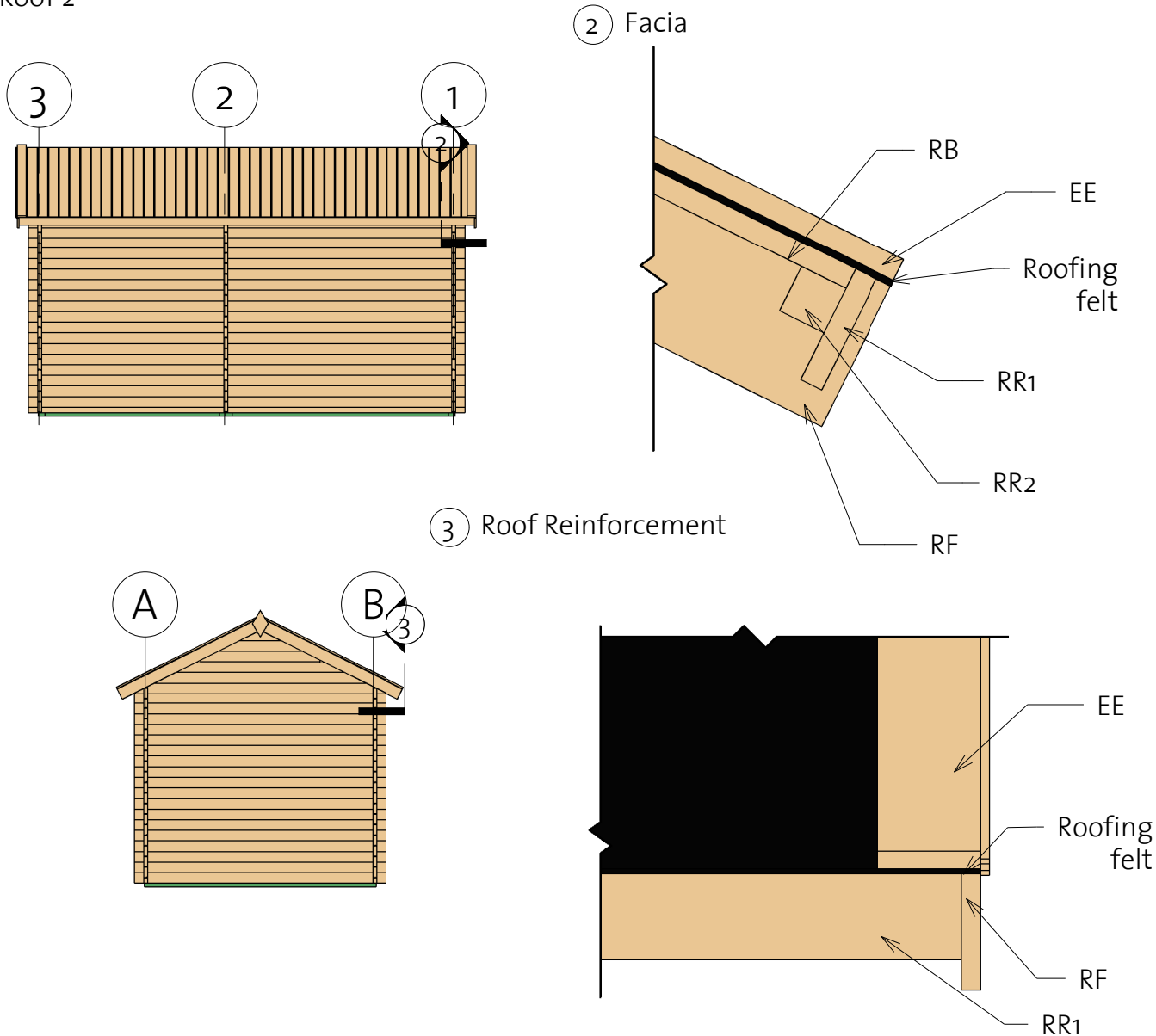



Fascia Schedule				
Mark	Type	Profile	Count	Length
EE	Eave Edging 18x95		4	1717
RF	Roof Fascia 18x120		4	1717
RR1	Roof reinforcement 18x95		2	4900
RR2	Roof reinforcement 38x38		2	4900

Sauna Gable B 40 (250x450)

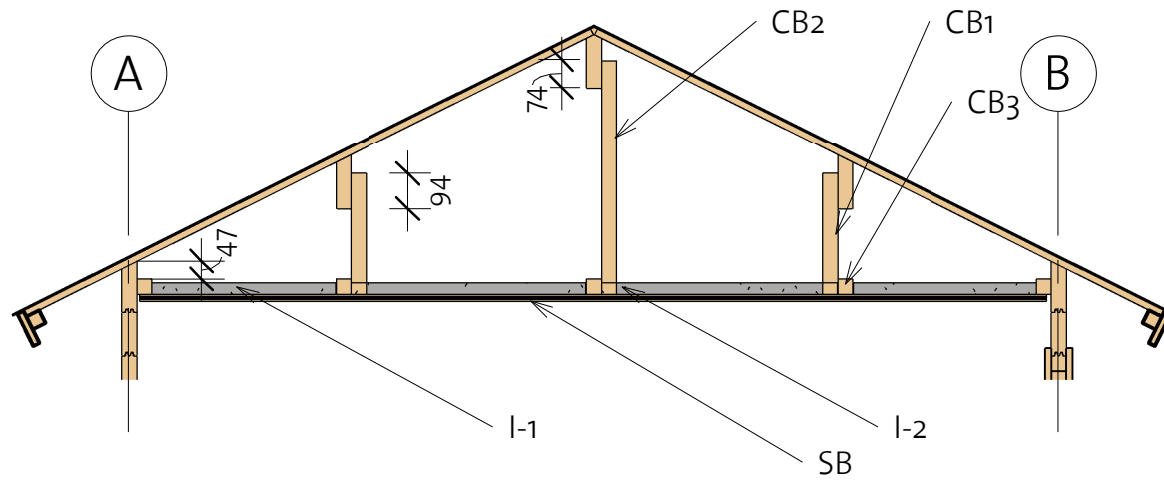
Ceiling



Ceiling Schedule				
Mark	Type	Profile	Count	Length
CB1	40x40		8	320
CB2	40x40		4	620
CB3	40x40		5	2415
SB	15x80		31	2400

Insulation Schedule			
Mark	Type	Count	Length
I-1	Insulation 486	2	2400
I-2	Insulation 622	2	2400

Sauna Gable B 40 (250x450)

Extras

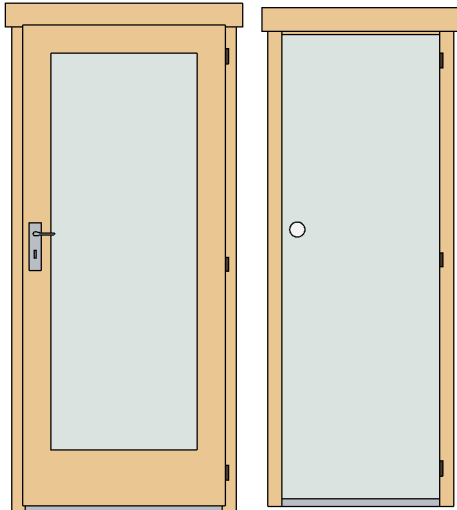

Door Schedule				
Model	Type	Width	Height	Count
SD	Sauna door	685	1920	1
CD6R	Classic door 6 right	840	1955	1

Type	Count
------	-------

Romb	2
------	---



- * Windows intended for tilt opening only!
- * Fenster zur Eröffnung nur zum Kippen vorgesehen!
- * Aknad on ette nähtud ainult kaldu avamiseks!

Fasteners/Extras		
Name	Type	Count

Hitblock	300-400 mm	
Screws	5,0 x 70	30
Nails	1,4 x 40	45
Screws	6,0 x 140	60
Screws	4,0 x 40	650

Window Schedule				
Mark	Type	Width	Height	Count
CW4R	Classic window 4, right tempered	875	1890	2

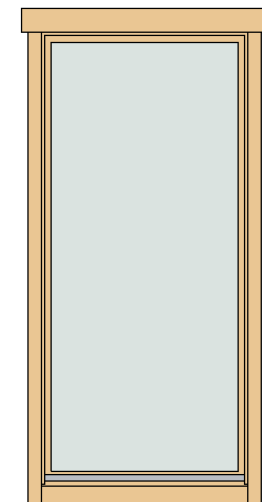

Sauna Gable B 40 (250x450)

List of all items 1

Impregnated foundation beams



Mark	Type	Profile	Count	Length
IFB1	IFB 70x40		4	2490
IFB2	IFB 70x40		5	2335
IFB3	IFB 70x40		5	1875

Floor Schedule





Mark	Type	Profile	Count	Length
FB	FB 17x114		39	2414

BB1	BB 18x40		6	2500
BB2	BB 18x40		2	2000

Roof

Mark	Type	Profile	Count	Length
RB	17x114		88	1677
RFB1	Beam 40x143		1	4900
RFB2	Beam 40x143		1	4900
RFR	Ridge 40x143		1	4900

Fascia Schedule

Mark	Type	Profile	Count	Length
EE	Eave Edging 18x95		4	1717
RF	Roof Fascia 18x120		4	1717
RR1	Roof reinforce ment 18x95		2	4900
RR2	Roof reinforce ment 38x38		2	4900

Sauna Gable B 40 (250x450)

List of all items 2

Wall 1			
Mark	Profile	Count	Cut Length

1LG-1 *	40X114	1	442
1LG-2 *	40X114	1	901
1LG-3 *	40X114	1	1287
1LG-4 *	40X114	1	1817
1LG-5 *	40X114	1	2275
1LG-6 *	40X114	1	2700
1LG-7	40X114	19	2700

Wall 3			
Mark	Profile	Count	Cut Length

3LG-1 *	40X114	1	442
3LG-2 *	40X114	1	901
3LG-3 *	40X114	1	1287
3LG-4 *	40X114	1	1817
3LG-5 *	40X114	1	2275
3LG-6 *	40X114	1	2700
3LG-7	40X114	19	2700

Wall A			
Mark	Profile	Count	Cut Length

ABL-1	40X57	1	4700
ALG-1	40X114	18	4700
ATL-1	40X135	1	4900

Wall 2			
Mark	Profile	Count	Cut Length

2LG-1 *	40X114	1	442
2LG-2 *	40X114	1	901
2LG-3 *	40X114	1	1287
2LG-4 *	40X114	1	1817
2LG-5 *	40X114	1	2275
2LG-6 *	40X114	1	2700
2LG-7	40X114	2	2700
2LG-8	40X114	17	1710
2LG-9	40X114	17	300

* Gable - delivered premounted

Wall B			
Mark	Profile	Count	Cut Length

BBL-1	40X57	1	3155
BBL-2	40X57	1	695
BLG-1	40X114	17	300
BLG-2	40X114	17	340
BLG-3	40X114	17	755
BLG-4	40X114	17	695
BLG-5	40X114	1	4700
BTL-1	40X135	1	4900



Sauna Gable B 40 (250x450)

List of all items 3



Insulation Schedule			
Mark	Type	Count	Length

I-1	Insulation 486	2	2400
I-2	Insulation 622	2	2400

Ceiling Schedule				
Mark	Type	Profile	Count	Length

CB1	40x40		8	320
CB2	40x40		4	620
CB3	40x40		5	2415
SB	15x80		31	2400

Log profiles	
Profile	Profile

40x57	
40x135	
40x114	