

# Sauna Gable C 40 (98 3/8" x 299 1/4")

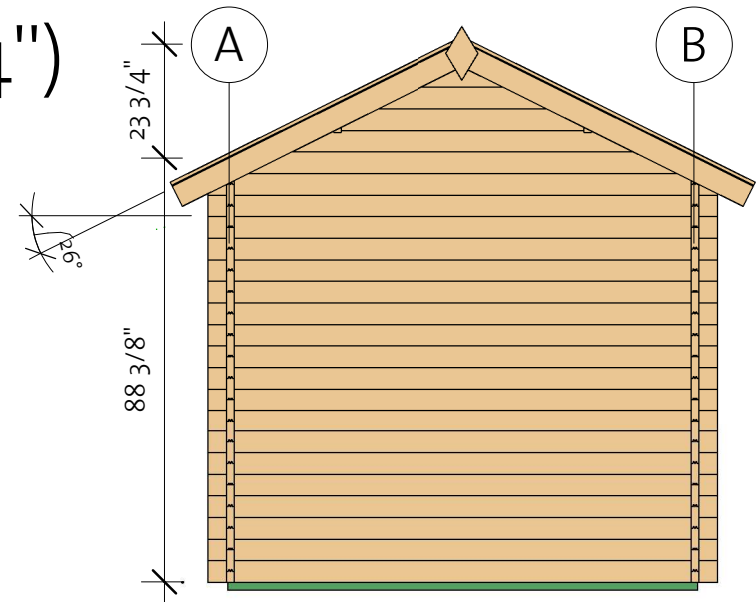

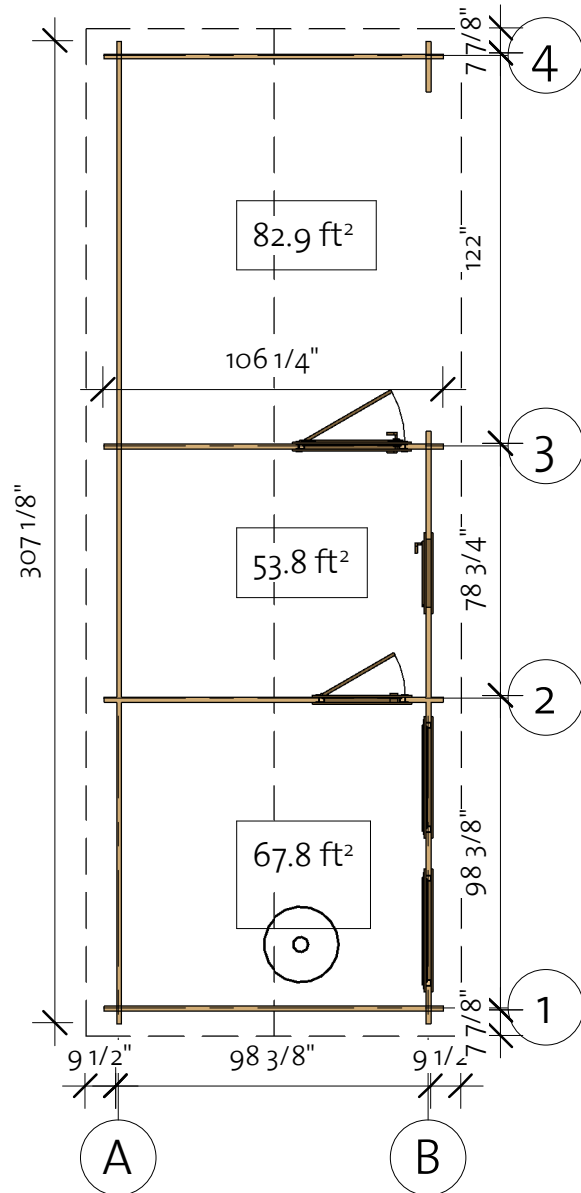

92503059\_251024

**EZ** Log Structures  
Do-It-Yourself Building Kits

# Sauna Gable C 40 (98 3/8"x299 1/4")

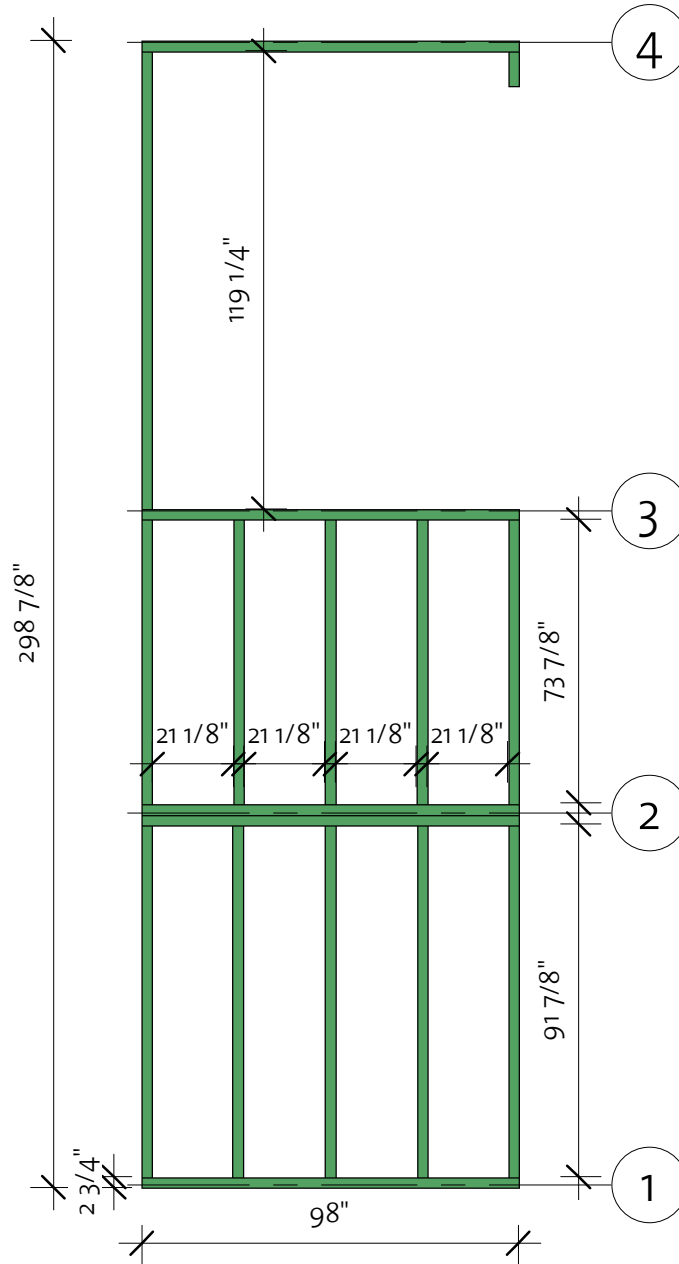
Foundation



Impregnated foundation beams				
Mark	Type	Profile	Count	Length
IFB1	IFB 70x40		5	98"
IFB2	IFB 70x40		5	91 7/8"
IFB3	IFB 70x40		5	73 7/8"
IFB4	IFB 70x40		1	119 1/4"
IFB5	IFB 70x40		1	9"

# Sauna Gable C 40 (98 3/8"x299 1/4")

Floor Plan

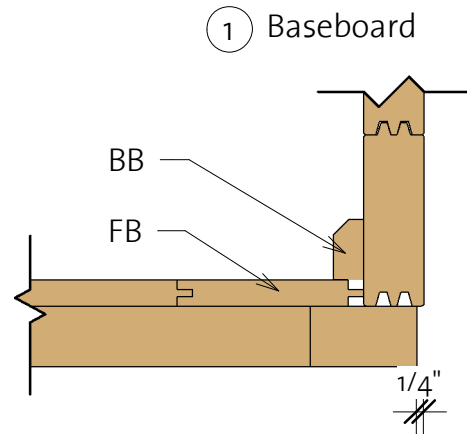

Floor Schedule				
Mark	Type	Profile	Count	Length

FB	FB 17x114		39	95"
----	-----------	---	----	-----

BB1	BB 18x40		6	98 3/8"
BB2	BB 18x40		2	78 3/4"

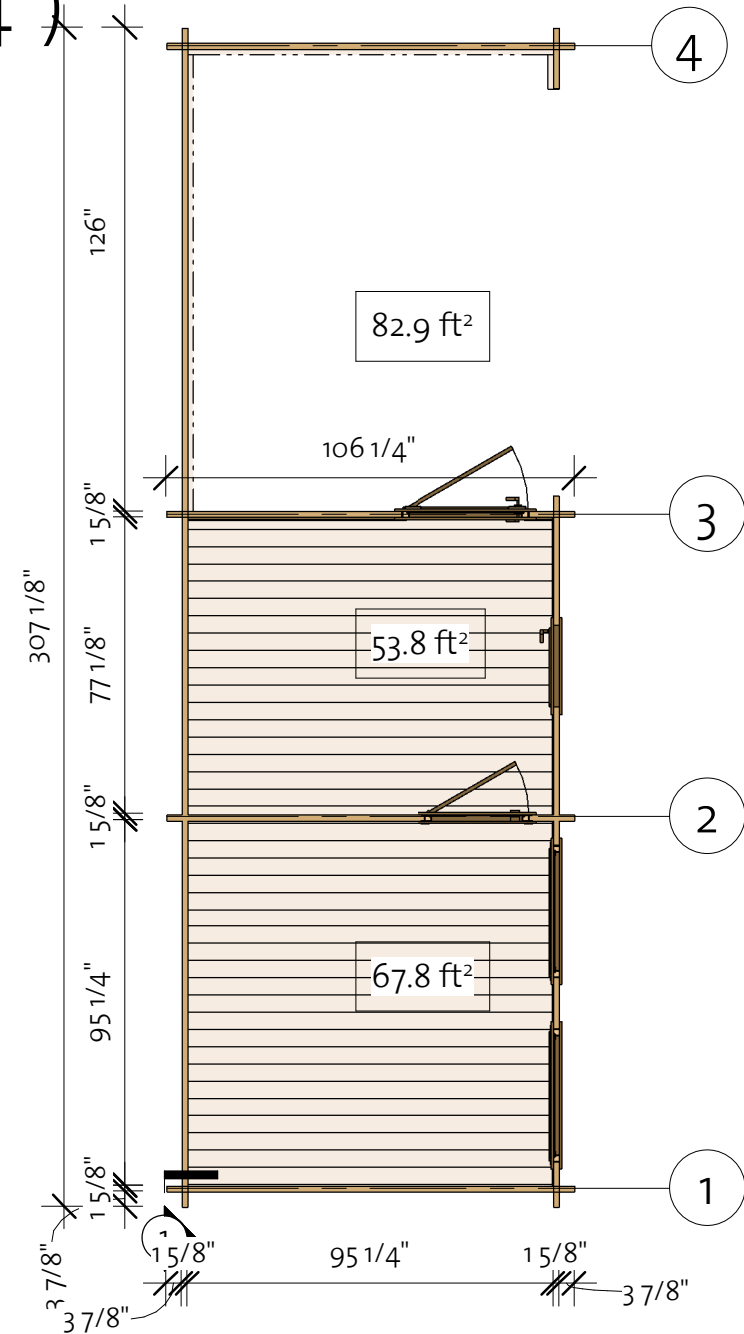

# Sauna Gable C 40 (98 3/8"x299 1/4")

Wall 1

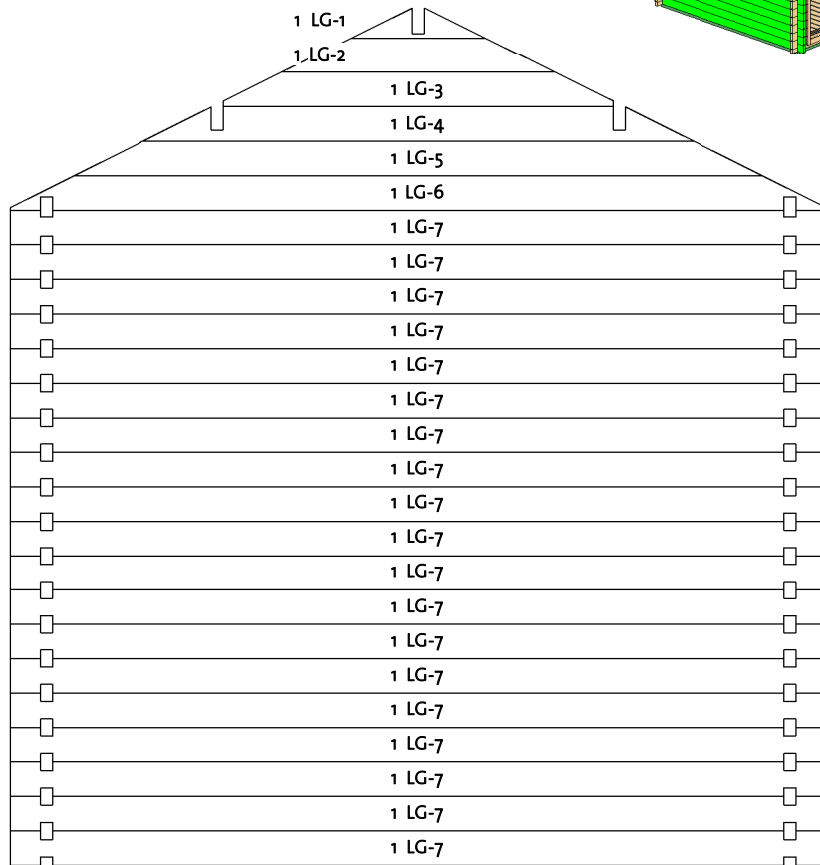
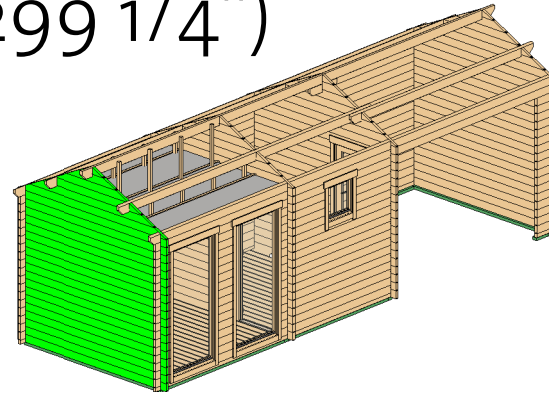

106 1/4"

Wall 1			
Mark	Profile	Count	Cut Length

1LG-1 *	40X114	1	17 3/8"
1LG-2 *	40X114	1	35 1/2"
1LG-3 *	40X114	1	50 5/8"
1LG-4 *	40X114	1	71 1/2"
1LG-5 *	40X114	1	89 5/8"
1LG-6 *	40X114	1	106 1/4"
1LG-7	40X114	19	106 1/4"

\* Gable - delivered premounted

Log Profile Wall 1

Profile

Profile

40X114

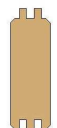



# Sauna Gable C 40 (98 3/8"x299 1/4")

Wall 3

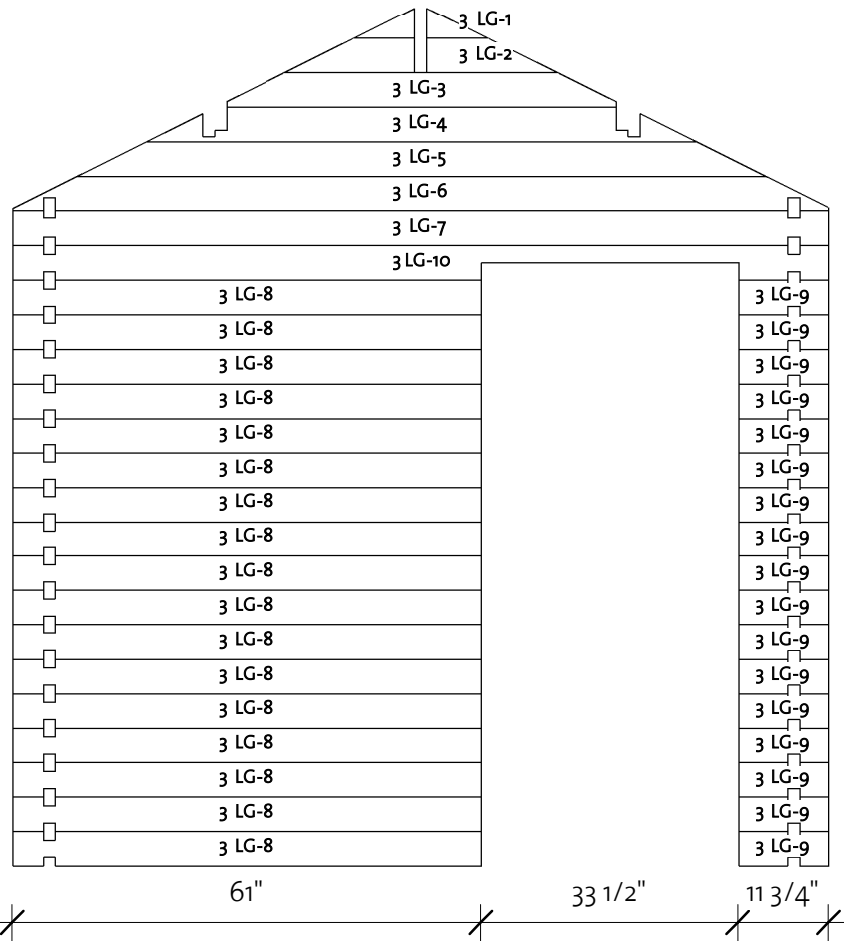
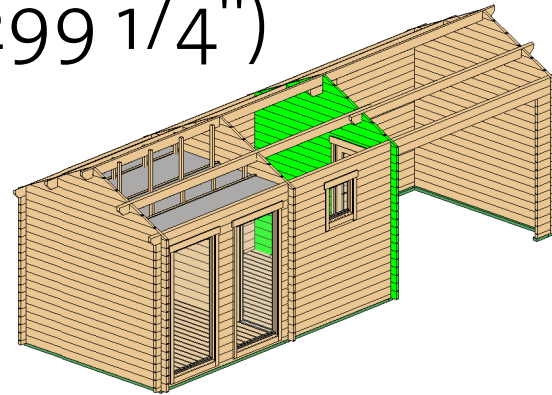

Wall 3			
Mark	Profile	Count	Cut Length

3LG-1 *	40X114	1	17 3/8"
3LG-2 *	40X114	1	35 1/2"
3LG-3 *	40X114	1	50 5/8"
3LG-4 *	40X114	1	71 1/2"
3LG-5 *	40X114	1	89 5/8"
3LG-6 *	40X114	1	106 1/4"
3LG-7	40X114	1	106 1/4"
3LG-8	40X114	17	61"
3LG-9	40X114	17	11 3/4"
3LG-10	40X114	1	106 1/4"

\* Gable - delivered premounted

Log Profile Wall 3	
Profile	Profile

40X114	
--------	--



# Sauna Gable C 40 (98 3/8"x299 1/4")

Wall A

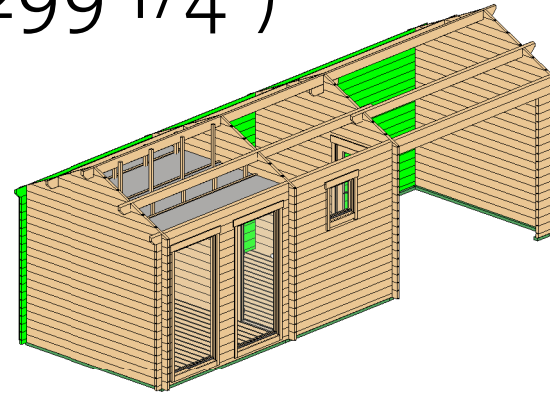

Wall A			
Mark	Profile	Count	Cut Length

ABL-1	40x57	1	180 3/8"
ABL-2	40x57	1	126 3/4"
ALG-1	40x114	9	101 5/8"
ALG-2	40x114	9	205 1/2"
ALG-3	40x114	9	180 3/8"
ALG-4	40x114	9	126 3/4"
ATL-1	40x135	1	105 1/2"
ATL-2	40x135	1	209 1/2"

## Log Profile Wall A

Profile	Profile
---------	---------

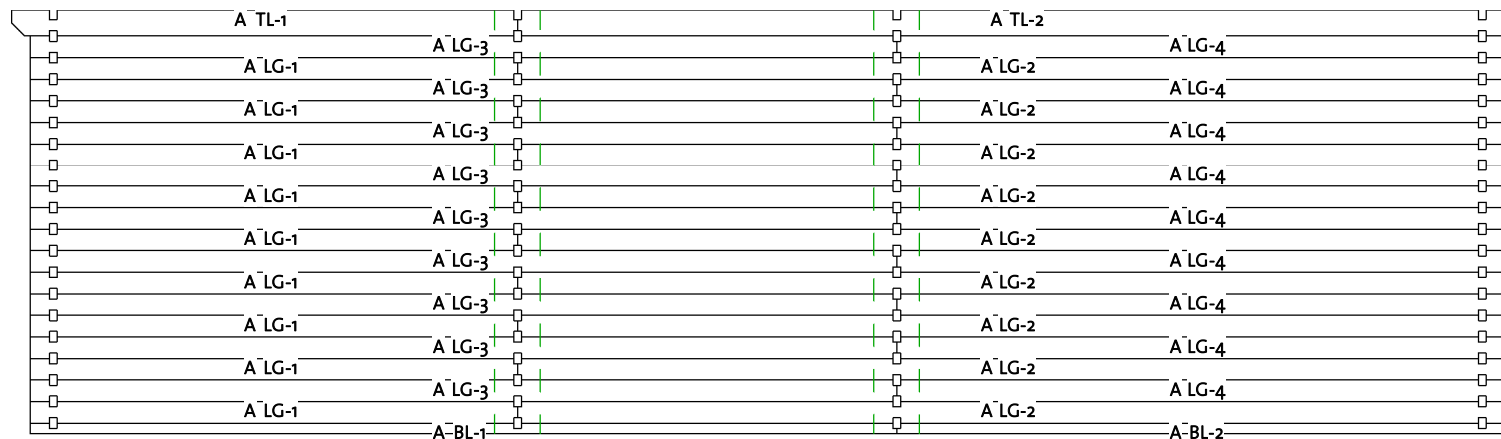

3 7/8"

307 1/8"

3 7/8"

40x57	
40x114	
40x135	

# Sauna Gable C 40 (98 3/8"x299 1/4")

Wall B

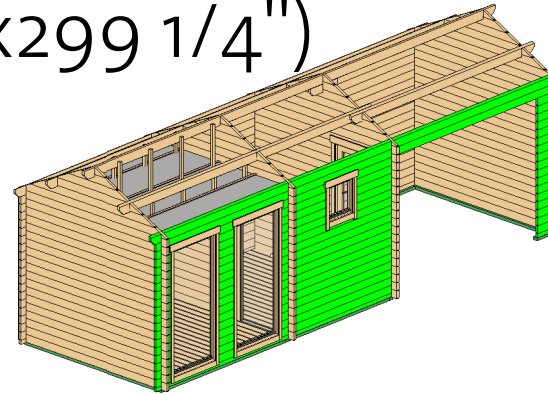

Log Profile Wall B	
Profile	Profile

40X57	
-------	---

Wall B			
Mark	Profile	Count	Cut Length

BBL-1	40X57	1	185"
BBL-2	40X57	1	15 3/4"
BLG-1	40X114	17	11 3/4"
BLG-2	40X114	17	13 3/8"
BLG-3	40X114	17	15 3/4"
BLG-4	40X114	5	33 3/8"
BLG-5	40X114	4	35 3/4"
BLG-6	40X114	1	35 3/4"
BLG-7	40X114	12	90 1/2"
BLG-8	40X114	1	205 1/2"
BLG-9	40X114	1	101 5/8"
BTL-1	40X135	1	105 1/2"
BTL-2	40X135	1	209 1/2"

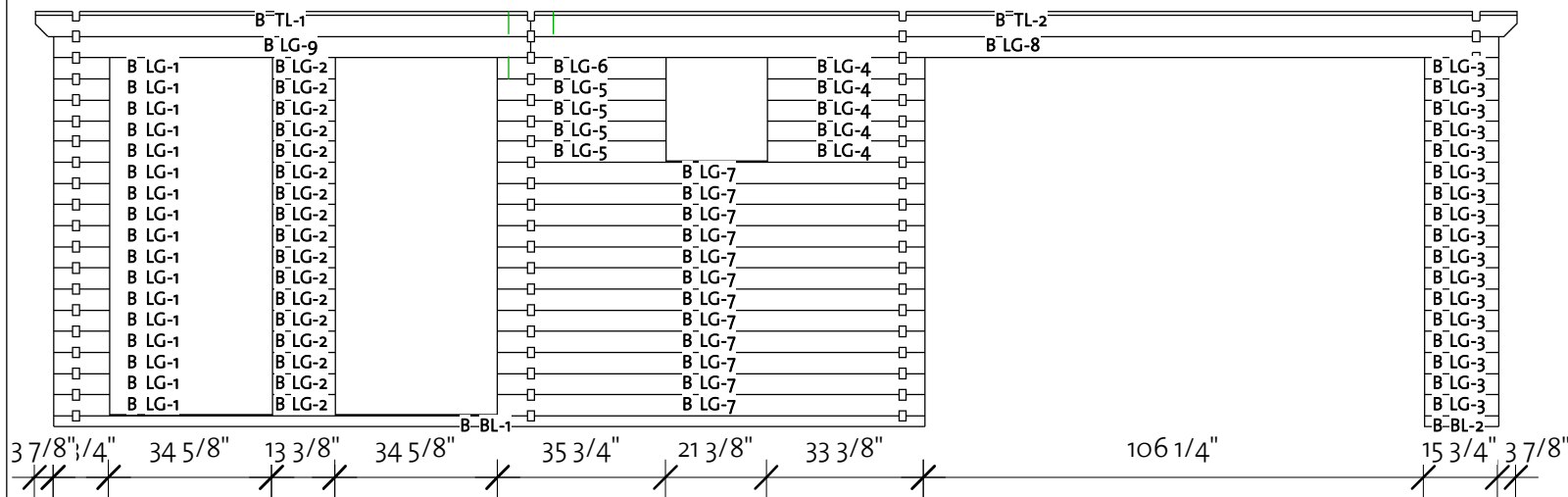

Log Profile Wall B	
Profile	Profile

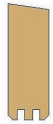
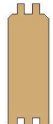

40X135	
40X114	

92503059\_251024

# Sauna Gable C 40 (98 3/8"x299 1/4")

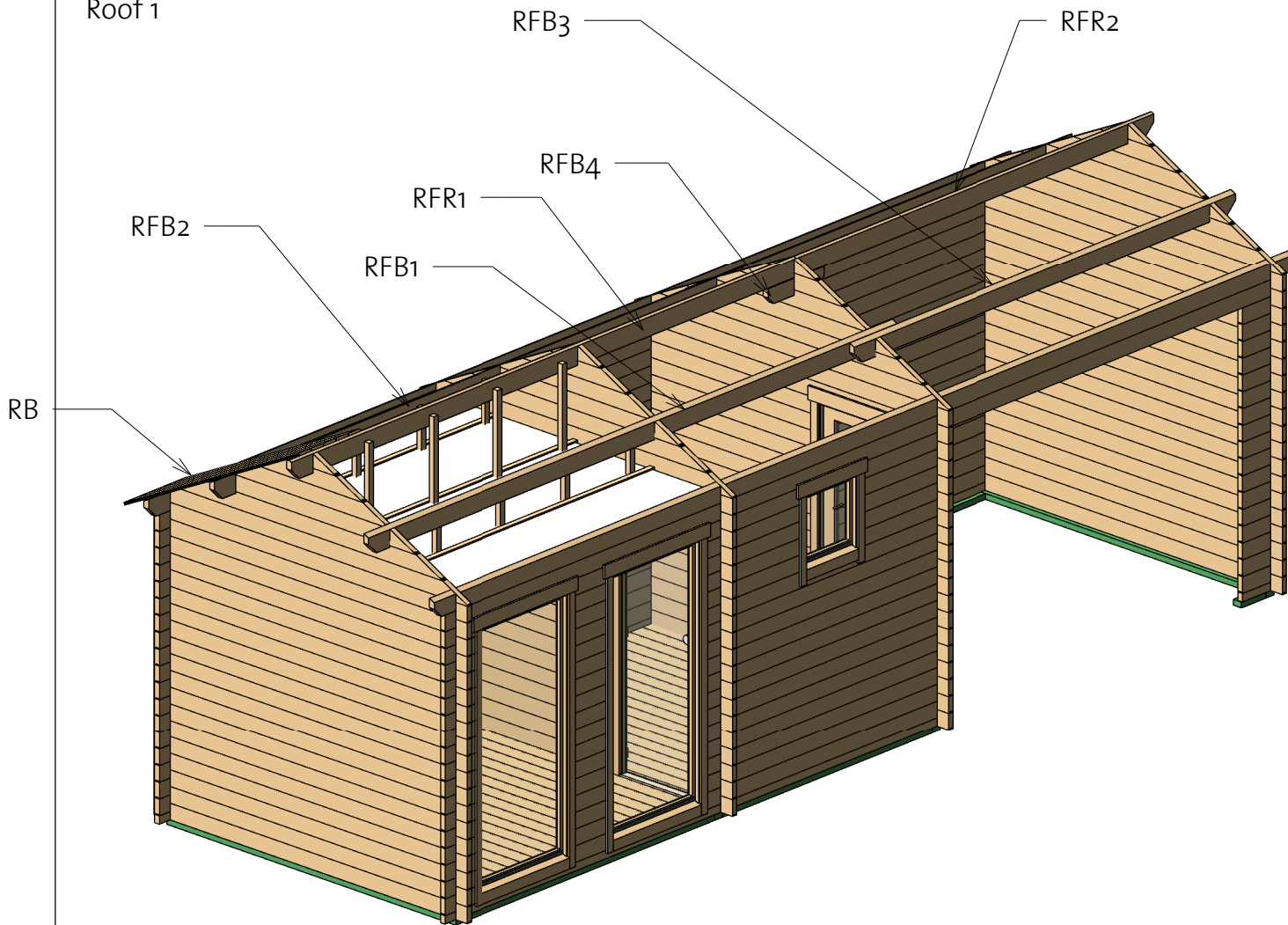
Roof 1

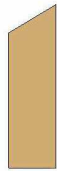

Roof				
Mark	Type	Profile	Count	Length
RB	17x114		142	66"
RFB1	Beam 40x143		1	192 7/8"
RFB2	Beam 40x143		1	192 7/8"
RFB3	Beam 40x143		2	139 3/8"
RFB4	Beam 40x120		1	20 1/2"
RFR1	Ridge 40x143		1	184 1/4"
RFR2	Ridge 40x143		1	130 3/4"

# Sauna Gable C 40 (98 3/8"x299 1/4")

Roof 2

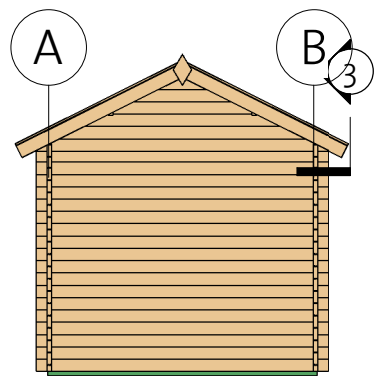
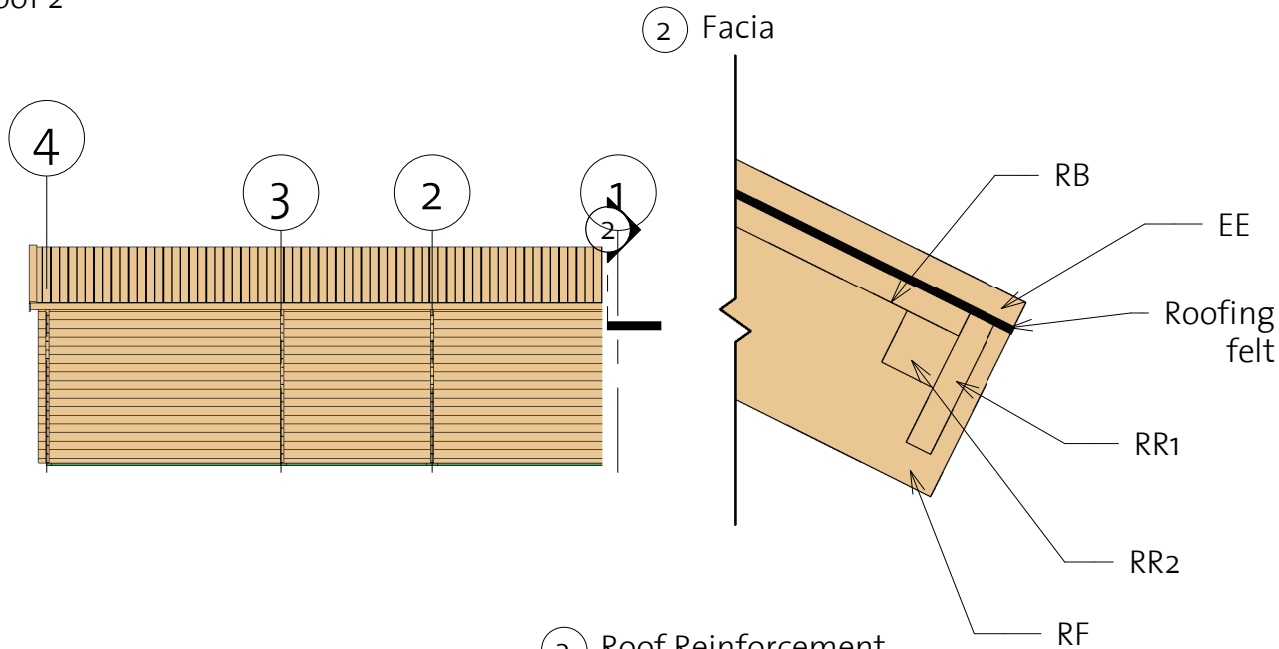

3) Roof Reinforcement

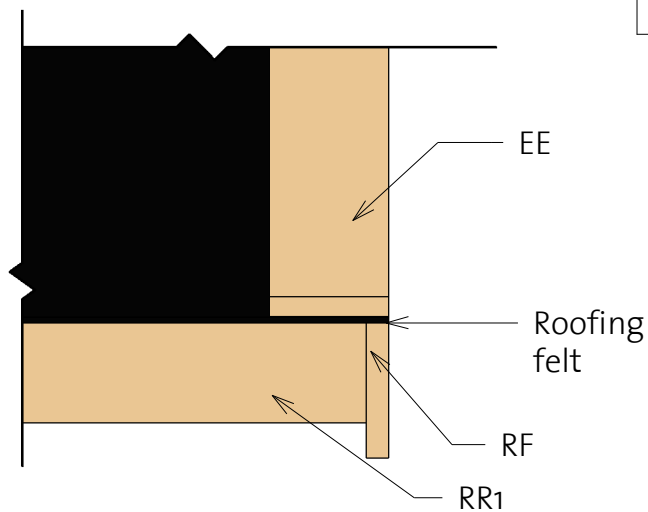



Fascia Schedule				
Mark	Type	Profile	Count	Length
EE	Eave Edging 18x95		4	67 5/8"
RF	Roof Fascia 18x120		4	67 5/8"
RR1	Roof reinforcement 18x95		4	157 1/2"
RR2	Roof reinforcement 38x38		4	157 1/2"

# Sauna Gable C 40 (98 3/8"x299 1/4")

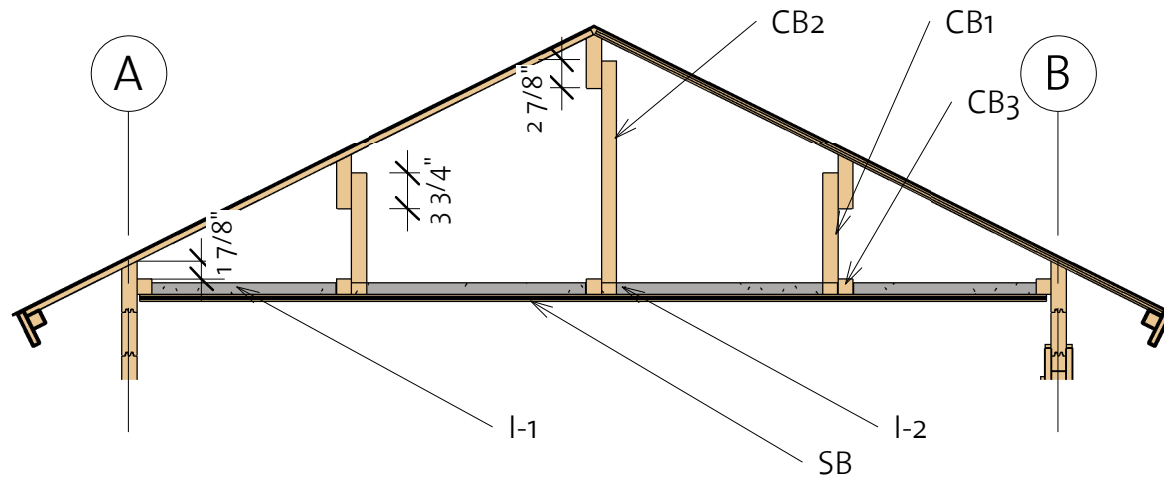
Ceiling



Ceiling Schedule				
Mark	Type	Profile	Count	Length
CB1	40x40		8	12 5/8"
CB2	40x40		4	24 3/8"
CB3	40x40		5	95 1/8"
SB	15x80		31	94 1/2"

Insulation Schedule			
Mark	Type	Count	Length
I-1	Insulation 486	2	94 1/2"
I-2	Insulation 622	2	94 1/2"

# Sauna Gable C 40 (98 3/8"x299 1/4")

Extras

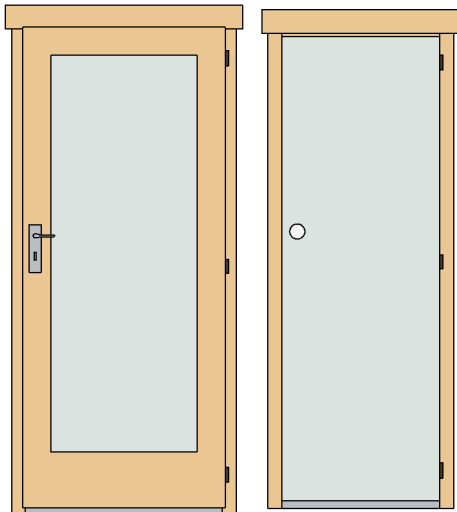

Door Schedule				
Model	Type	Width	Height	Count
SD	Sauna door	27"	75 5/8"	1
CD6R	Classic door 6 right	33 1/8"	77"	1

Type	Count
------	-------

Romb	2
------	---



Fasteners/Extras		
Name	Type	Count

Hitblock	300-400 mm	
Nails	1,4 x 40	45
Screws	5,0 x 70	50
Screws	6,0 x 140	70
Dowels	16,0 x 150	76
Screws	4,0 x 40	880

Window Schedule				
Mark	Type	Width	Height	Count
CW4R	Classic window 4, right tempered	34 1/2"	74 3/8"	2
CW12R	Classic window 12, full glass righth	21 1/4"	21 1/4"	1

- \* Windows intended for tilt opening only!
- \* Fenster zur Eröffnung nur zum Kippen vorgesehen!
- \* Aknad on ette nähtud ainult kaldu avamiseks!

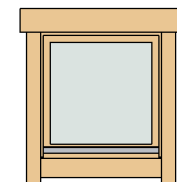
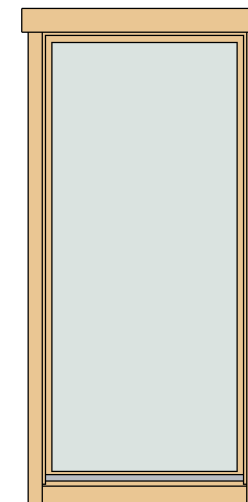





# Sauna Gable C 40 (98 3/8"x299 1/4")

## List of all items 1

### Impregnated foundation beams

Mark	Type	Profile	Count	Length
IFB1	IFB 70x40		5	98"
IFB2	IFB 70x40		5	91 7/8"
IFB3	IFB 70x40		5	73 7/8"
IFB4	IFB 70x40		1	119 1/4"
IFB5	IFB 70x40		1	9"

### Fascia Schedule





Mark	Type	Profile	Count	Length
EE	Eave Edging 18x95		4	67 5/8"
RF	Roof Fascia 18x120		4	67 5/8"
RR1	Roof reinforce ment 18x95		4	157 1/2"
RR2	Roof reinforce ment 38x38		4	157 1/2"

### Floor Schedule

Mark	Type	Profile	Count	Length
FB	FB 17x114		39	95"

BB1	BB 18x40		6	98 3/8"
BB2	BB 18x40		2	78 3/4"

### Roof

Mark	Type	Profile	Count	Length
RB	17x114		142	66"
RFB1	Beam 40x143		1	192 7/8"
RFB2	Beam 40x143		1	192 7/8"
RFB3	Beam 40x143		2	139 3/8"
RFB4	Beam 40x120		1	20 1/2"
RFR1	Ridge 40x143		1	184 1/4"
RFR2	Ridge 40x143		1	130 3/4"

# Sauna Gable C 40 (98 3/8"x299 1/4")

## List of all items 2

Wall 1			
Mark	Profile	Count	Cut Length

1LG-1 *	40X114	1	17 3/8"
1LG-2 *	40X114	1	35 1/2"
1LG-3 *	40X114	1	50 5/8"
1LG-4 *	40X114	1	71 1/2"
1LG-5 *	40X114	1	89 5/8"
1LG-6 *	40X114	1	106 1/4"
1LG-7	40X114	19	106 1/4"

Wall 3			
Mark	Profile	Count	Cut Length

3LG-1 *	40X114	1	17 3/8"
3LG-2 *	40X114	1	35 1/2"
3LG-3 *	40X114	1	50 5/8"
3LG-4 *	40X114	1	71 1/2"
3LG-5 *	40X114	1	89 5/8"
3LG-6 *	40X114	1	106 1/4"
3LG-7	40X114	1	106 1/4"
3LG-8	40X114	17	61"
3LG-9	40X114	17	11 3/4"
3LG-10	40X114	1	106 1/4"

Wall 4			
Mark	Profile	Count	Cut Length

4LG-1 *	40X114	1	17 3/8"
4LG-2 *	40X114	1	35 1/2"
4LG-3 *	40X114	1	53 1/2"
4LG-4 *	40X114	1	71 1/2"
4LG-5 *	40X114	1	89 5/8"
4LG-6 *	40X114	1	106 1/4"
4LG-7	40X114	19	106 1/4"

Wall 2			
Mark	Profile	Count	Cut Length

2LG-1 *	40X114	1	17 3/8"
2LG-2 *	40X114	1	35 1/2"
2LG-3 *	40X114	1	50 5/8"
2LG-4 *	40X114	1	71 1/2"
2LG-5 *	40X114	1	89 5/8"
2LG-6 *	40X114	1	106 1/4"
2LG-7	40X114	2	106 1/4"
2LG-8	40X114	17	67 3/8"
2LG-9	40X114	17	11 3/4"

\* Gable - delivered premounted



# Sauna Gable C 40 (98 3/8"x299 1/4")

## List of all items 3



Insulation Schedule			
Mark	Type	Count	Length

I-1	Insulation 486	2	94 1/2"
I-2	Insulation 622	2	94 1/2"

Ceiling Schedule				
Mark	Type	Profile	Count	Length

CB1	40x40		8	12 5/8"
CB2	40x40		4	24 3/8"
CB3	40x40		5	95 1/8"
SB	15x80		31	94 1/2"

Log profiles	
Profile	Profile

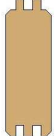
40x57	
40x135	
40x114	

Wall A			
Mark	Profile	Count	Cut Length

ABL-1	40x57	1	180 3/8"
ABL-2	40x57	1	126 3/4"
ALG-1	40x114	9	101 5/8"
ALG-2	40x114	9	205 1/2"
ALG-3	40x114	9	180 3/8"
ALG-4	40x114	9	126 3/4"
ATL-1	40x135	1	105 1/2"
ATL-2	40x135	1	209 1/2"

Wall B			
Mark	Profile	Count	Cut Length

BBL-1	40x57	1	185"
BBL-2	40x57	1	15 3/4"
BLG-1	40x114	17	11 3/4"
BLG-2	40x114	17	13 3/8"
BLG-3	40x114	17	15 3/4"
BLG-4	40x114	5	33 3/8"
BLG-5	40x114	4	35 3/4"
BLG-6	40x114	1	35 3/4"
BLG-7	40x114	12	90 1/2"
BLG-8	40x114	1	205 1/2"
BLG-9	40x114	1	101 5/8"
BTL-1	40x135	1	105 1/2"
BTL-2	40x135	1	209 1/2"