

Sauna Gable C 40 (250x760)

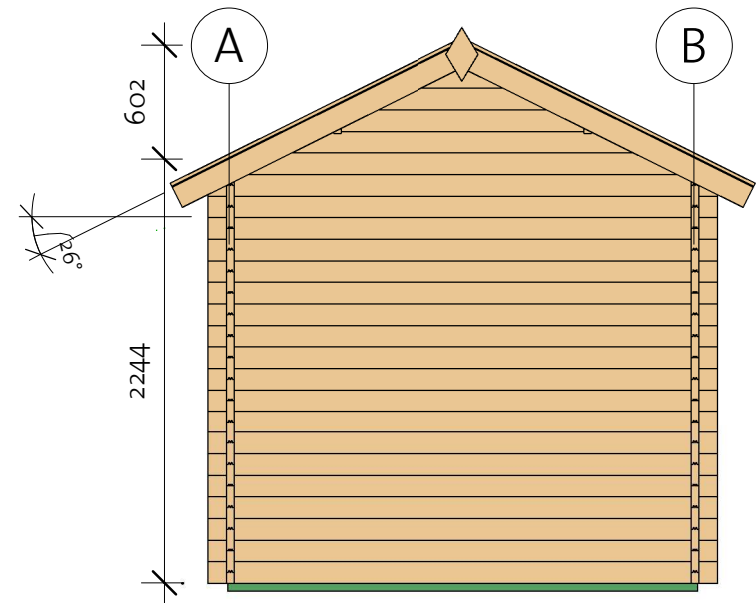

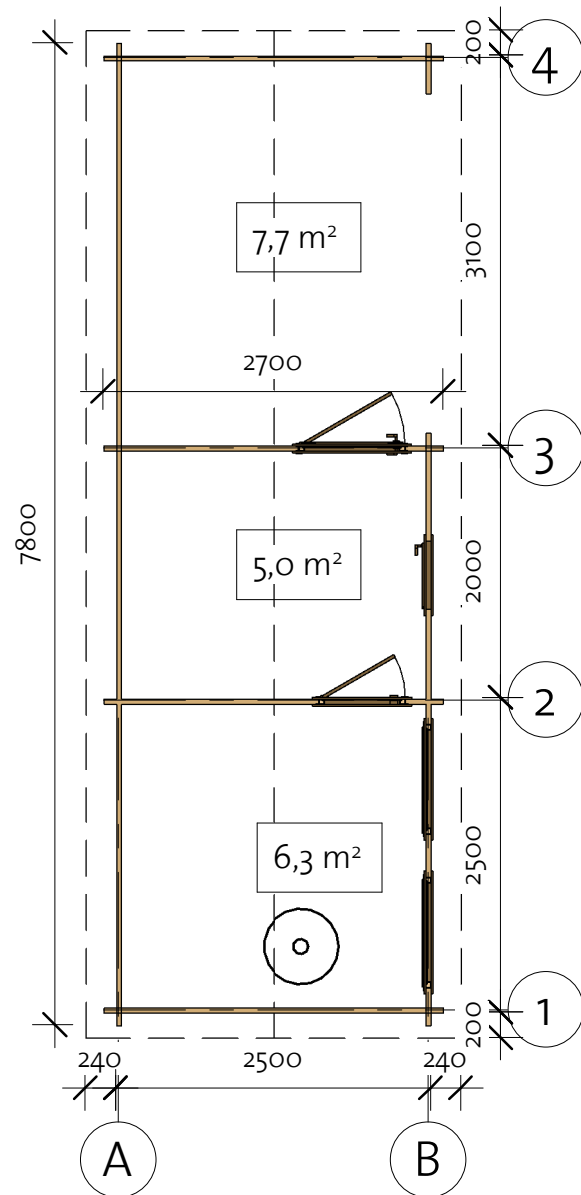

92503059_251024

EZ Log Structures
Do-It-Yourself Building Kits

Sauna Gable C 40 (250x760)

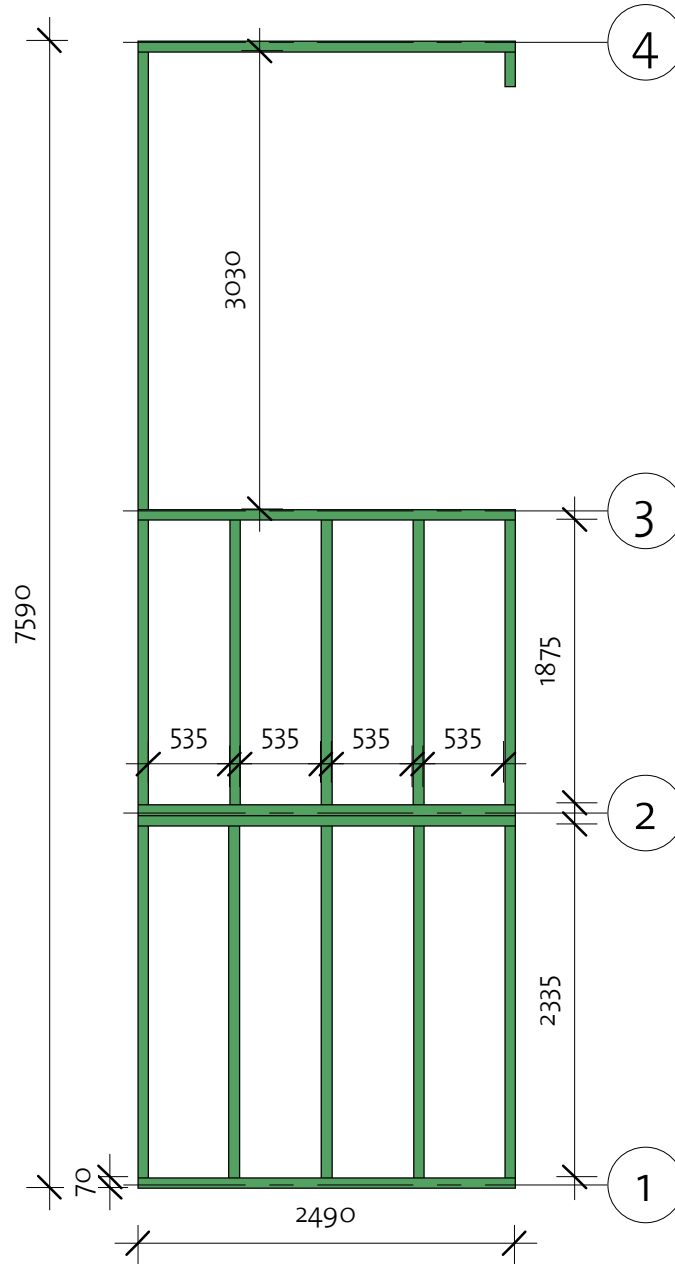
Foundation



Impregnated foundation beams				
Mark	Type	Profile	Count	Length
IFB1	IFB 70x40		5	2490
IFB2	IFB 70x40		5	2335
IFB3	IFB 70x40		5	1875
IFB4	IFB 70x40		1	3030
IFB5	IFB 70x40		1	230

Sauna Gable C 40 (250x760)

Floor Plan

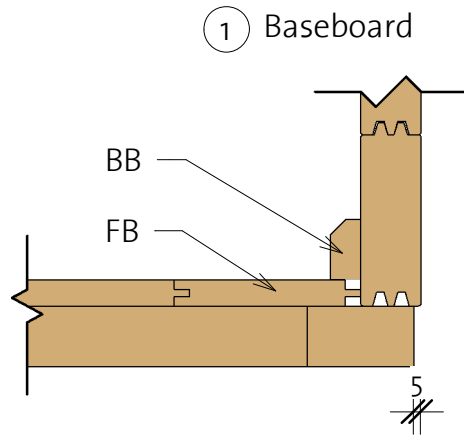

Floor Schedule

Mark	Type	Profile	Count	Length
------	------	---------	-------	--------

FB	FB 17x114		39	2414
----	-----------	---	----	------

BB1	BB 18x40		6	2500
BB2	BB 18x40		2	2000

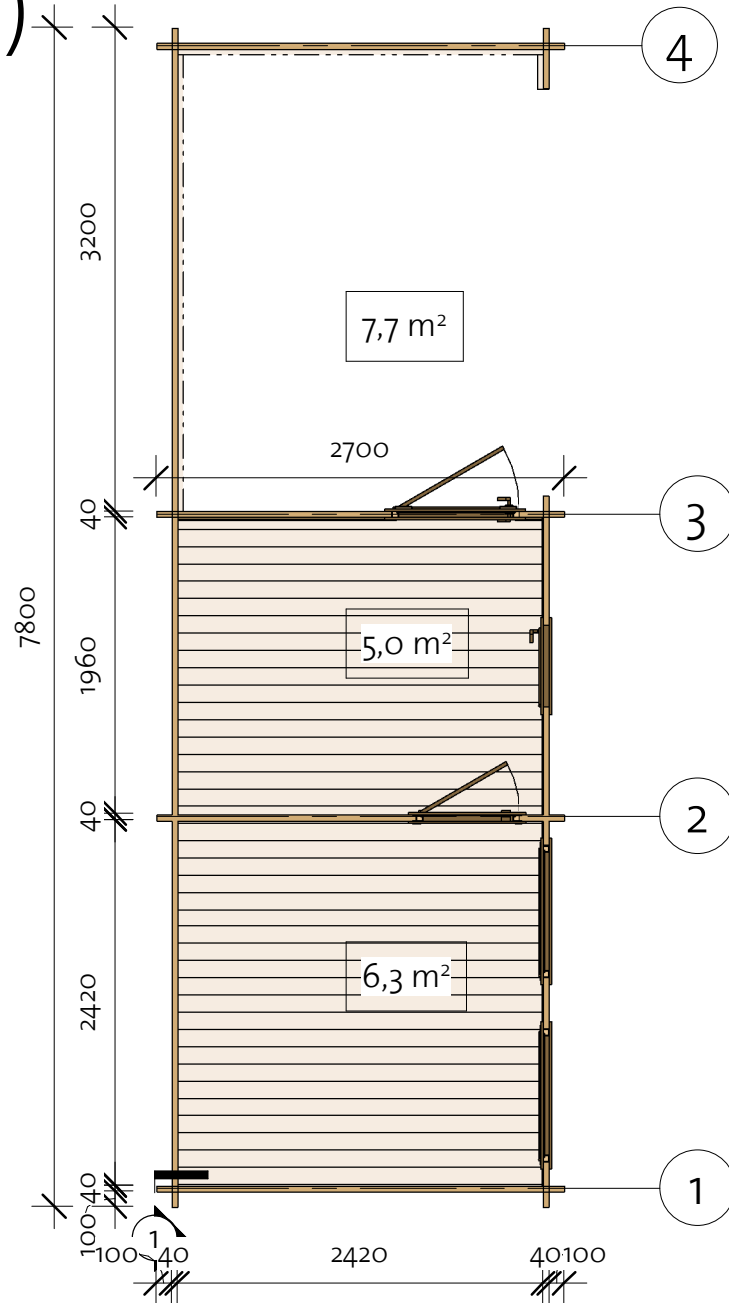

Sauna Gable C 40 (250x760)

Wall 1

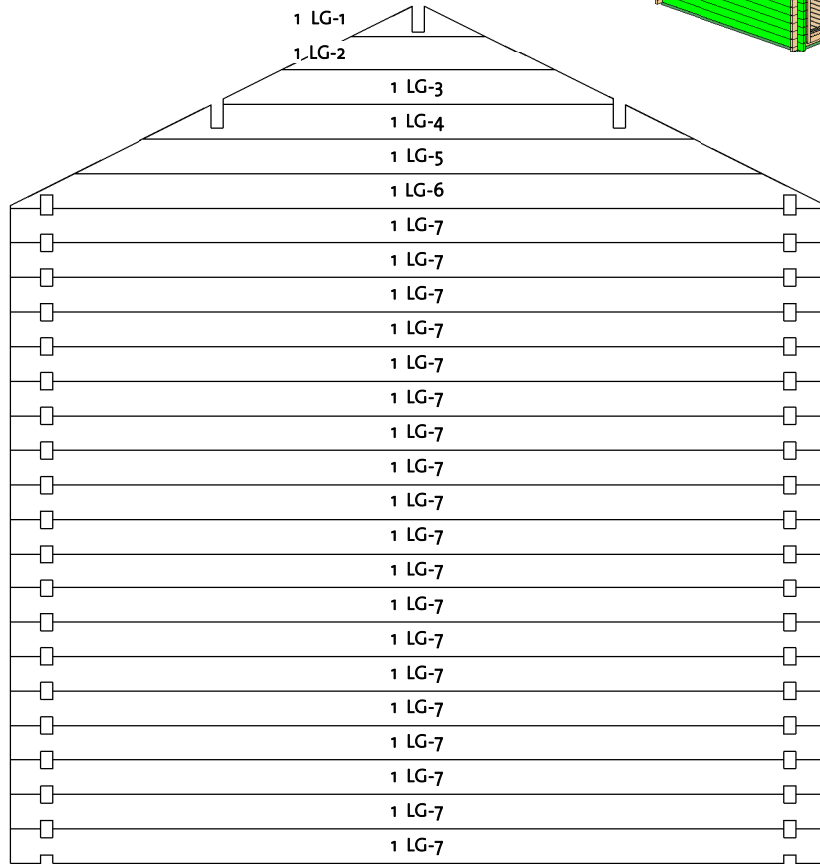
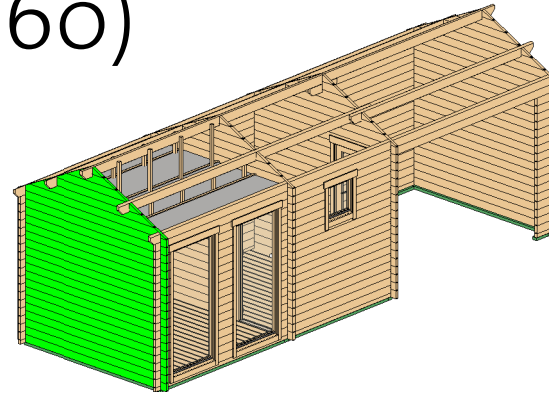

Wall 1			
Mark	Profile	Count	Cut Length

1LG-1 *	40X114	1	442
1LG-2 *	40X114	1	901
1LG-3 *	40X114	1	1287
1LG-4 *	40X114	1	1817
1LG-5 *	40X114	1	2275
1LG-6 *	40X114	1	2700
1LG-7	40X114	19	2700

* Gable - delivered premounted

Log Profile Wall 1

Profile

Profile

40X114

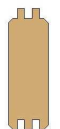

2700

Sauna Gable C 40 (250x760)

Wall 3

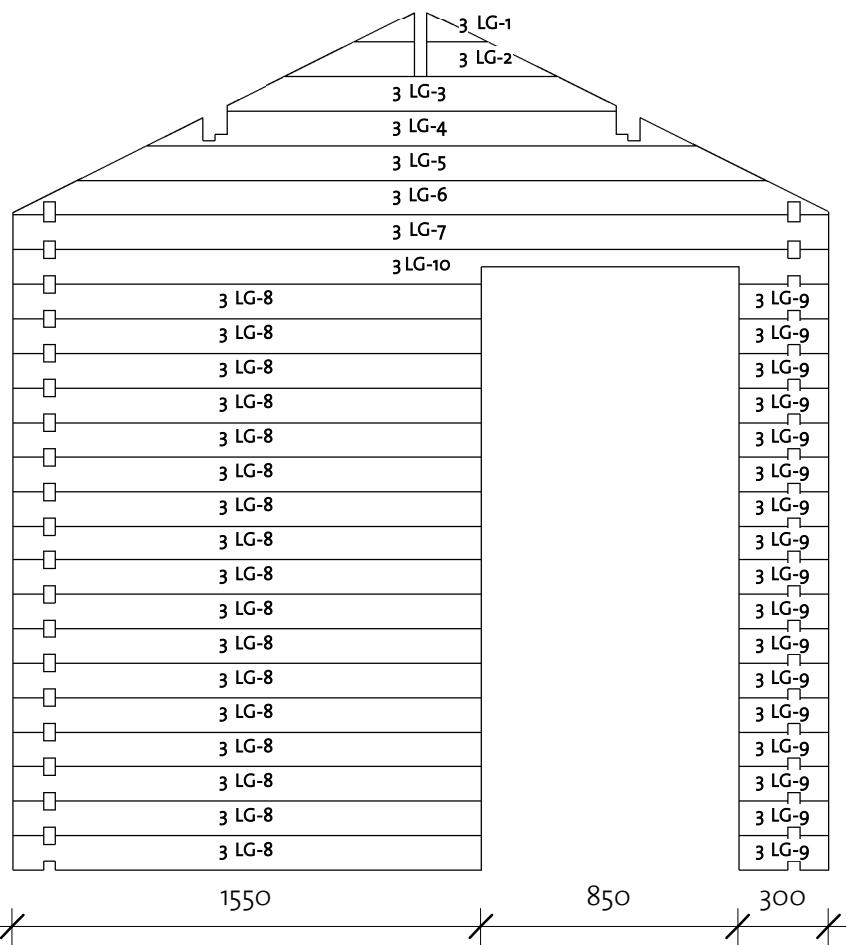
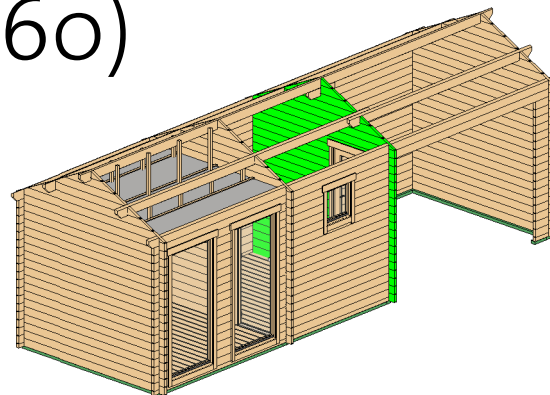

Wall 3			
Mark	Profile	Count	Cut Length

3LG-1 *	40X114	1	442
3LG-2 *	40X114	1	901
3LG-3 *	40X114	1	1287
3LG-4 *	40X114	1	1817
3LG-5 *	40X114	1	2275
3LG-6 *	40X114	1	2700
3LG-7	40X114	1	2700
3LG-8	40X114	17	1550
3LG-9	40X114	17	300
3LG-10	40X114	1	2700

* Gable - delivered premounted

Log Profile Wall 3	
Profile	Profile

40X114	
--------	--

Sauna Gable C 40 (250x760)

Wall 4

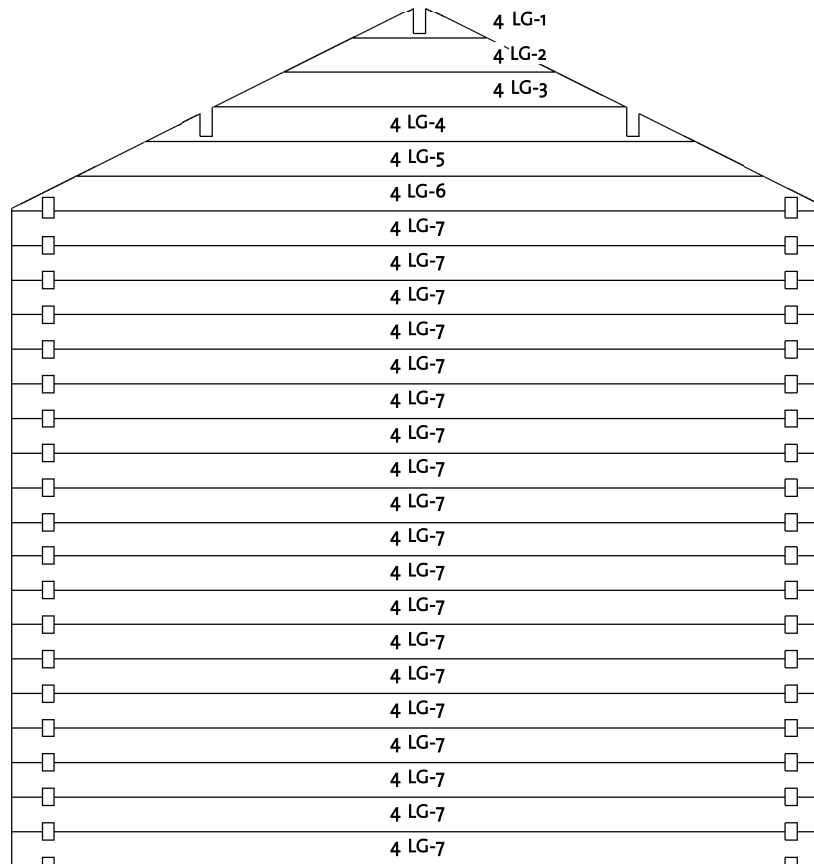
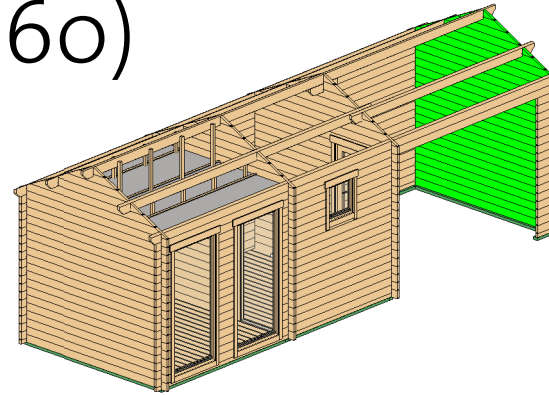

Wall 4			
Mark	Profile	Count	Cut Length

4LG-1 *	40X114	1	442
4LG-2 *	40X114	1	901
4LG-3 *	40X114	1	1359
4LG-4 *	40X114	1	1817
4LG-5 *	40X114	1	2275
4LG-6 *	40X114	1	2700
4LG-7	40X114	19	2700

* Gable - delivered premounted

Log Profile Wall 4	
Profile	Profile

40X114	
--------	--

Sauna Gable C 40 (250x760)

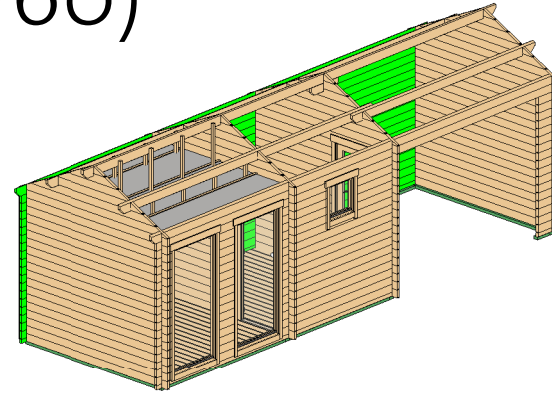

Wall A



Wall A			
Mark	Profile	Count	Cut Length

ABL-1	40x57	1	4580
ABL-2	40x57	1	3220
ALG-1	40x114	9	2580
ALG-2	40x114	9	5220
ALG-3	40x114	9	4580
ALG-4	40x114	9	3220
ATL-1	40x135	1	2680
ATL-2	40x135	1	5320

Log Profile Wall A	
Profile	Profile

40x57	
40x114	
40x135	

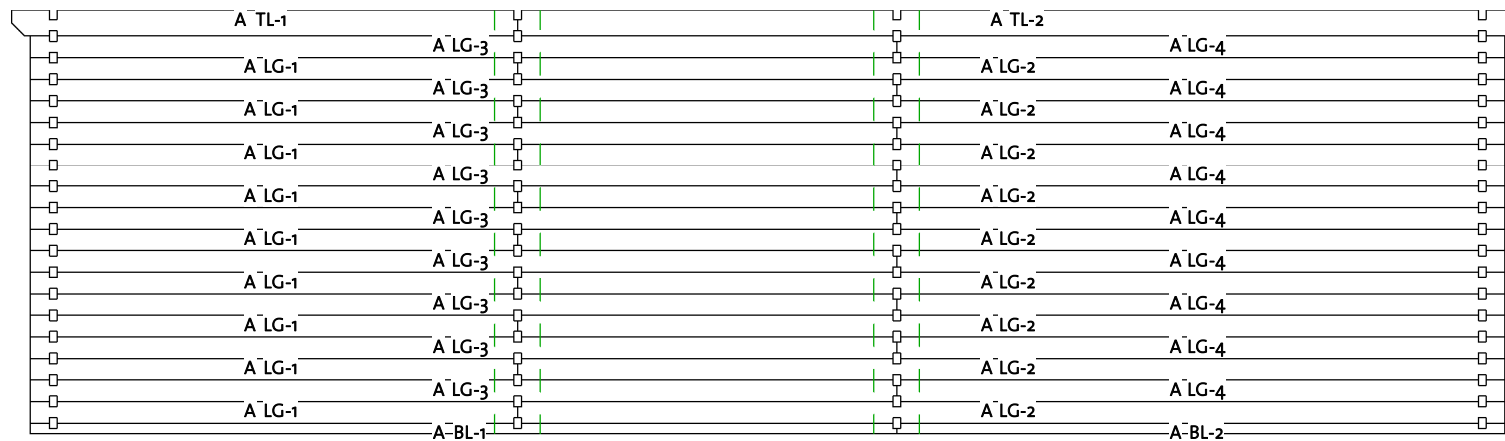

100
//

7800

100
//

Sauna Gable C 40 (250x760)

Wall B

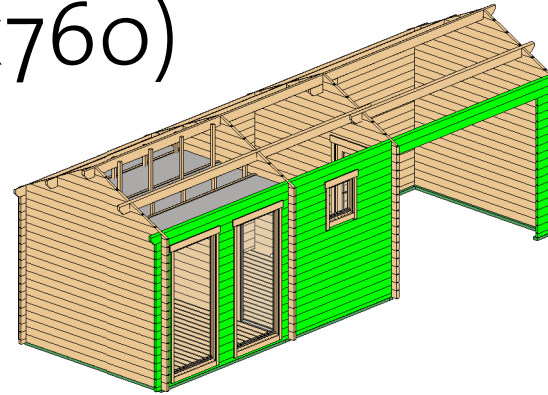

Log Profile Wall B	
Profile	Profile

40X57	
-------	---

Wall B			
Mark	Profile	Count	Cut Length

BBL-1	40X57	1	4700
BBL-2	40X57	1	400
BLG-1	40X114	17	300
BLG-2	40X114	17	340
BLG-3	40X114	17	400
BLG-4	40X114	5	848
BLG-5	40X114	4	908
BLG-6	40X114	1	908
BLG-7	40X114	12	2300
BLG-8	40X114	1	5220
BLG-9	40X114	1	2580
BTL-1	40X135	1	2680
BTL-2	40X135	1	5320

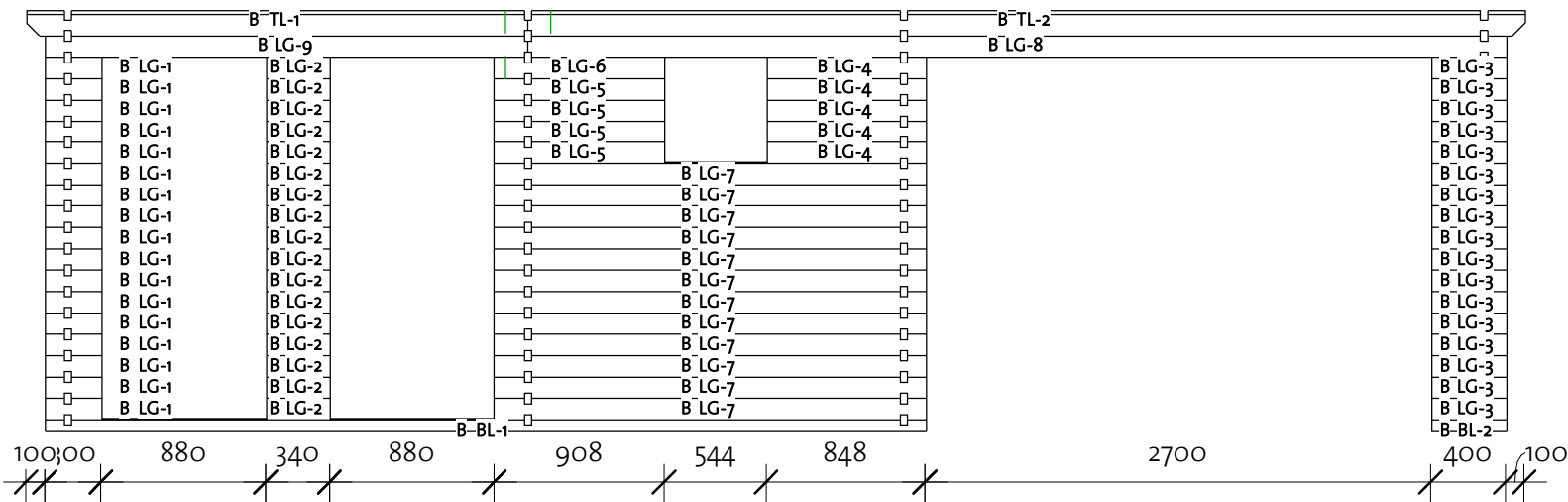

Log Profile Wall B	
Profile	Profile

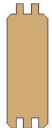

40X135	
40X114	

92503059_251024

Sauna Gable C 40 (250x760)

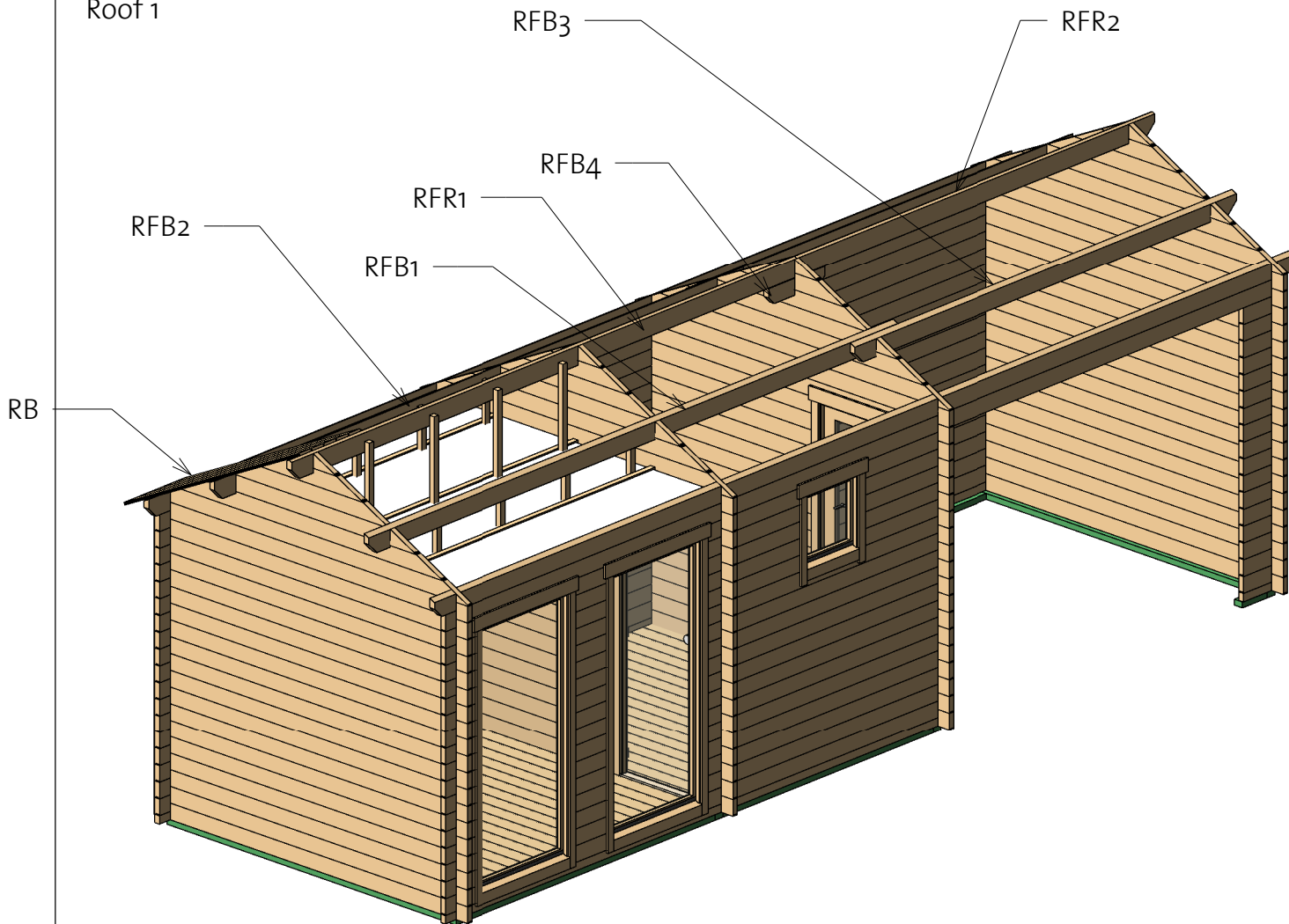
Roof 1

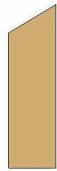

Roof				
Mark	Type	Profile	Count	Length
RB	17x114		142	1677
RFB1	Beam 40x143		1	4900
RFB2	Beam 40x143		1	4900
RFB3	Beam 40x143		2	3540
RFB4	Beam 40x120		1	520
RFR1	Ridge 40x143		1	4680
RFR2	Ridge 40x143		1	3320

Sauna Gable C 40 (250x760)

Roof 2

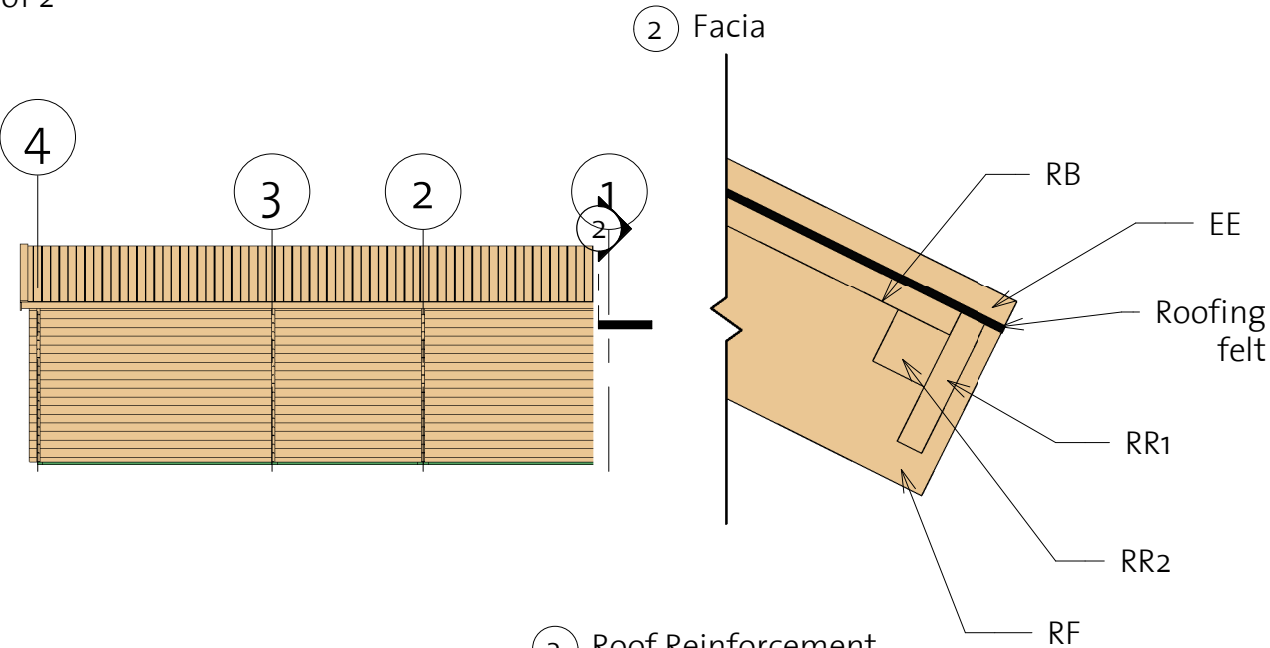

3) Roof Reinforcement

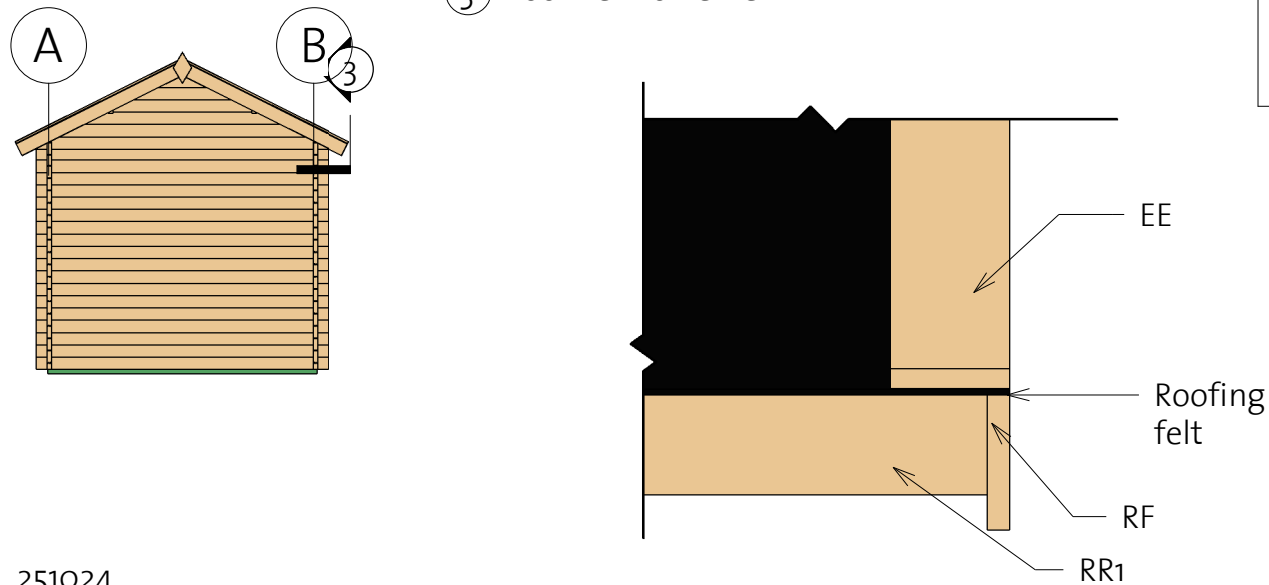



Fascia Schedule				
Mark	Type	Profile	Count	Length
EE	Eave Edging 18x95		4	1717
RF	Roof Fascia 18x120		4	1717
RR1	Roof reinforcement 18x95		4	4000
RR2	Roof reinforcement 38x38		4	4000

Sauna Gable C 40 (250x760)

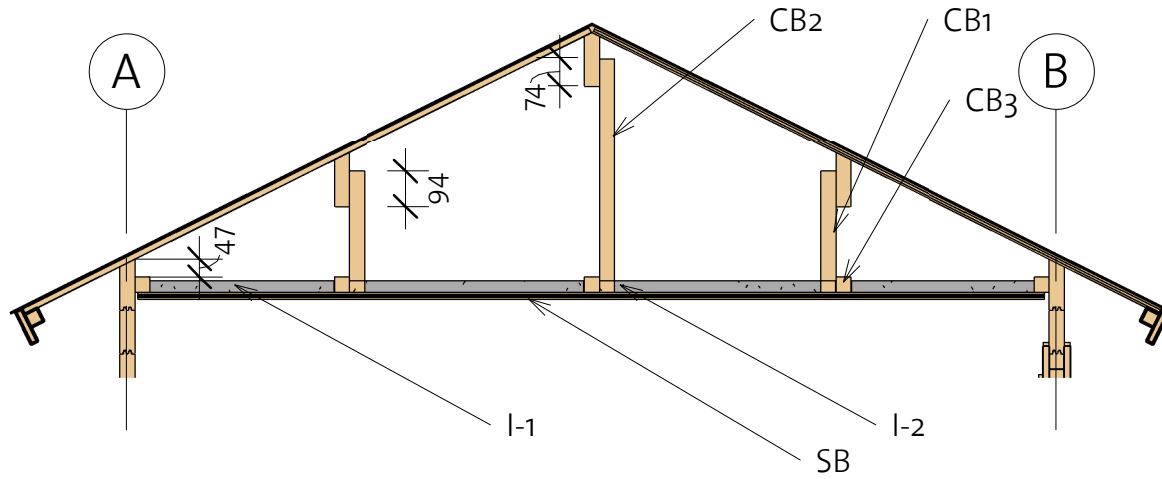
Ceiling



Ceiling Schedule

Mark	Type	Profile	Count	Length
CB1	40x40		8	320
CB2	40x40		4	620
CB3	40x40		5	2415
SB	15x80		31	2400

Insulation Schedule

Mark	Type	Count	Length
I-1	Insulation 486	2	2400
I-2	Insulation 622	2	2400

Sauna Gable C 40 (250x760)

Extras

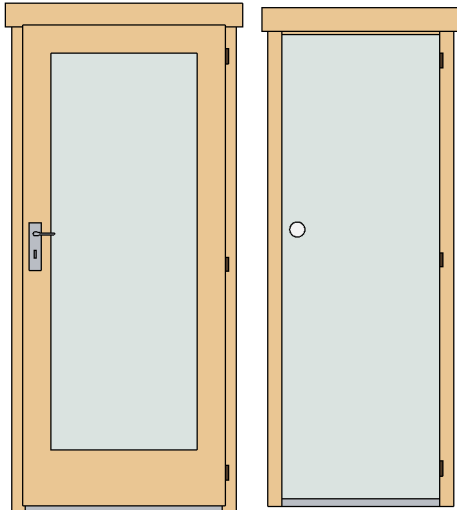

Door Schedule				
Model	Type	Width	Height	Count
SD	Sauna door	685	1920	1
CD6R	Classic door 6 right	840	1955	1

Type	Count
------	-------

Romb	2
------	---



Fasteners/Extras		
Name	Type	Count

Hitblock	300-400 mm	
Nails	1,4 x 40	45
Screws	5,0 x 70	50
Screws	6,0 x 140	70
Dowels	16,0 x 150	76
Screws	4,0 x 40	880

Window Schedule				
Mark	Type	Width	Height	Count
CW4R	Classic window 4, right tempered	875	1890	2
CW12R	Classic window 12, full glass righth	540	540	1

- * Windows intended for tilt opening only!
- * Fenster zur Eröffnung nur zum Kippen vorgesehen!
- * Aknad on ette nähtud ainult kaldu avamiseks!

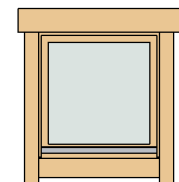
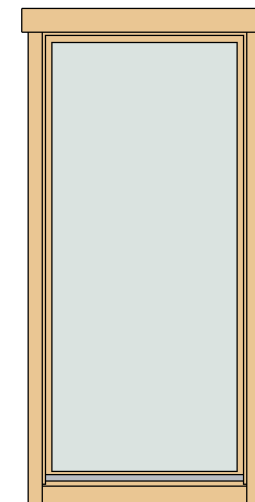





Sauna Gable C 40 (250x760)

List of all items 1

Impregnated foundation beams

Mark	Type	Profile	Count	Length
IFB1	IFB 70x40		5	2490
IFB2	IFB 70x40		5	2335
IFB3	IFB 70x40		5	1875
IFB4	IFB 70x40		1	3030
IFB5	IFB 70x40		1	230

Fascia Schedule





Mark	Type	Profile	Count	Length
EE	Eave Edging 18x95		4	1717
RF	Roof Fascia 18x120		4	1717
RR1	Roof reinforce ment 18x95		4	4000
RR2	Roof reinforce ment 38x38		4	4000

Floor Schedule

Mark	Type	Profile	Count	Length
FB	FB 17x114		39	2414

BB1	BB 18x40		6	2500
BB2	BB 18x40		2	2000

Roof

Mark	Type	Profile	Count	Length
RB	17x114		142	1677
RFB1	Beam 40x143		1	4900
RFB2	Beam 40x143		1	4900
RFB3	Beam 40x143		2	3540
RFB4	Beam 40x120		1	520
RFR1	Ridge 40x143		1	4680
RFR2	Ridge 40x143		1	3320

Sauna Gable C 40 (250x760)

List of all items 2

Wall 1			
Mark	Profile	Count	Cut Length

1LG-1 *	40X114	1	442
1LG-2 *	40X114	1	901
1LG-3 *	40X114	1	1287
1LG-4 *	40X114	1	1817
1LG-5 *	40X114	1	2275
1LG-6 *	40X114	1	2700
1LG-7	40X114	19	2700

Wall 3			
Mark	Profile	Count	Cut Length

3LG-1 *	40X114	1	442
3LG-2 *	40X114	1	901
3LG-3 *	40X114	1	1287
3LG-4 *	40X114	1	1817
3LG-5 *	40X114	1	2275
3LG-6 *	40X114	1	2700
3LG-7	40X114	1	2700
3LG-8	40X114	17	1550
3LG-9	40X114	17	300
3LG-10	40X114	1	2700

Wall 4			
Mark	Profile	Count	Cut Length

4LG-1 *	40X114	1	442
4LG-2 *	40X114	1	901
4LG-3 *	40X114	1	1359
4LG-4 *	40X114	1	1817
4LG-5 *	40X114	1	2275
4LG-6 *	40X114	1	2700
4LG-7	40X114	19	2700

Wall 2			
Mark	Profile	Count	Cut Length

2LG-1 *	40X114	1	442
2LG-2 *	40X114	1	901
2LG-3 *	40X114	1	1287
2LG-4 *	40X114	1	1817
2LG-5 *	40X114	1	2275
2LG-6 *	40X114	1	2700
2LG-7	40X114	2	2700
2LG-8	40X114	17	1710
2LG-9	40X114	17	300

* Gable - delivered premounted



Sauna Gable C 40 (250x760)

List of all items 3



Insulation Schedule			
Mark	Type	Count	Length

I-1	Insulation 486	2	2400
I-2	Insulation 622	2	2400

Ceiling Schedule				
Mark	Type	Profile	Count	Length

CB1	40x40		8	320
CB2	40x40		4	620
CB3	40x40		5	2415
SB	15x80		31	2400

Log profiles	
Profile	Profile

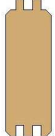
40x57	
40x135	
40x114	

Wall A			
Mark	Profile	Count	Cut Length

ABL-1	40x57	1	4580
ABL-2	40x57	1	3220
ALG-1	40x114	9	2580
ALG-2	40x114	9	5220
ALG-3	40x114	9	4580
ALG-4	40x114	9	3220
ATL-1	40x135	1	2680
ATL-2	40x135	1	5320

Wall B			
Mark	Profile	Count	Cut Length

BBL-1	40x57	1	4700
BBL-2	40x57	1	400
BLG-1	40x114	17	300
BLG-2	40x114	17	340
BLG-3	40x114	17	400
BLG-4	40x114	5	848
BLG-5	40x114	4	908
BLG-6	40x114	1	908
BLG-7	40x114	12	2300
BLG-8	40x114	1	5220
BLG-9	40x114	1	2580
BTL-1	40x135	1	2680
BTL-2	40x135	1	5320